

A photograph of an Atlas V rocket launching from a launch pad. The rocket is ascending vertically, leaving a massive, billowing plume of white and orange smoke and fire at its base. The launch pad structure is visible to the left of the rocket. The sky is a clear, pale blue.

# ATLAS V LAUNCH SERVICES User's Guide

March 2010



**ATLAS V LAUNCH SERVICES USER'S GUIDE**



United Launch Alliance  
9950 E. Easter Ave., Unit A  
Centennial, CO 80112  
[www.ulalaunch.com](http://www.ulalaunch.com)



**DISCLOSURE OF DATA LEGEND**

The information included in this document has been cleared for public release under OSR approval 10-S-0689, date: 16 February 2010 and has been placed in the public domain.

**PREFACE**

This *Atlas V Launch Services User's Guide* provides information on the vehicle capabilities of the Atlas V launch system. A range of vehicle configurations and performance levels is offered to allow an optimum match to customer requirements. The guide includes essential technical and programmatic data and requirements for preliminary mission planning and preliminary spacecraft design. Interfaces are in sufficient detail to assess first-order compatibility. A brief description of the Atlas V vehicles and launch facilities is also given.

Users are encouraged to contact the offices listed below to discuss the Atlas V launch vehicle family and how the Atlas V family satisfies user requirements, or email your questions to [contactus@ulalaunch.com](mailto:contactus@ulalaunch.com).

<b>ULA LAUNCH SERVICES BUSINESS INQUIRIES</b>	<b>ULA LAUNCH SERVICES TECHNICAL INQUIRIES</b>
<p><b>Christopher Ellerhorst</b> Director, Strategy, Business Development, and Sales <b>Telephone:</b> 303-269-5885 <b><a href="mailto:christopher.j.ellerhorst@ulalaunch.com">christopher.j.ellerhorst@ulalaunch.com</a></b></p> <p><b>Steve Furuto</b> Director, Finance &amp; Business Operations <b>Telephone:</b> 303-269-5511 <b><a href="mailto:steve.furuto@ulalaunch.com">steve.furuto@ulalaunch.com</a></b></p>	<p><b>Christopher Deel</b> Vice President, Engineering <b>Telephone:</b> 303-391-4838 <b><a href="mailto:chris.s.deel@ulalaunch.com">chris.s.deel@ulalaunch.com</a></b></p> <p><b>Gary Wentz</b> Vice President, Gov't &amp; Commercial Programs <b>Telephone:</b> 303-269-6555 <b><a href="mailto:gary.wentz@ulalaunch.com">gary.wentz@ulalaunch.com</a></b></p> <p><b>Postal Address:</b> United Launch Alliance 9950 E. Easter Ave., Unit A, Centennial, CO 80112</p>

This guide is subject to change and revision periodically. Revision 11 of the *Atlas V Launch Services User's Guide (AVUG)* has minor updates from the *Atlas Launch System Mission Planner's Guide*, Revision 10. The most significant changes are that this document addresses the performance of the Atlas V 400 and 500 series found in Section 2 and the guide has been rebranded as a ULA document. An itemized list of updates has been documented on the revisions page. Revision 11 of this document replaces all previous revisions of the Atlas Launch System Mission Planner's Guides.

This document can also be found on the Internet at: [www.ulalaunch.com](http://www.ulalaunch.com).

Atlas is a registered trademark of Lockheed Martin Corporation. United Launch Alliance, L.L.C. (ULA), United Launch Services, L.L.C. (ULS), and Perfect Product Delivery (PPD) are registered trademarks of United Launch Alliance, LLC.

**ATLAS V LAUNCH SERVICES USER'S GUIDE REVISIONS**

Revision Date	Rev No.	Change Description
March 2010	11	Entire Document — Updates Include: <ul style="list-style-type: none"> <li>• Updated Lockheed Martin and Commercial Launch Services references and content</li> <li>• Vehicle configurations reflect standard ULA branding template</li> <li>• Reordered and merged sections to reflect ULA branding</li> <li>• References to Common Core Boosters changed to Atlas booster</li> <li>• Updated Contraves Space Agency references to Ruag Space</li> </ul>
	11	Section 1 <ul style="list-style-type: none"> <li>• Updated Lockheed Martin and Commercial Launch Services to ULA references and relationship</li> <li>• Figures 1.4.1.3: 400 Series Launch System and Figure 1.4.1.4: Atlas V 500 Series Launch System made current</li> <li>• Updated Performance numbers in Figure 1.4.1.6</li> <li>• Added 1.4.7 Auxiliary and Dual Payload Accommodations reference</li> </ul>
	11	Section 2 <ul style="list-style-type: none"> <li>• Corrected SC Perigee burn location in Figure 2.3.1.1-1</li> <li>• Updated Table 2.3.1-1: GTO Option Benefits</li> <li>• Updated Tables 2.3.3-2 and -3: Injection Accuracy Results</li> <li>• Updated Table 2.5.1-1: Performance Effects of SC Required Hardware</li> <li>• Included Truss Adapter to Figure 2.5.1-1: Payload Systems Weight Definition</li> <li>• Removed Figure 2.5.6-1: Heavy spacecraft Interfaces</li> <li>• Updated Section 2.5.2.2: PLF Performance Partial</li> <li>• Updated Section 2.5.5: Centaur Coast Capability</li> <li>• All tables and figures reflect updated Atlas V performance levels</li> <li>• Removed C3 and max apogee figures and tables and revised text</li> <li>• Reduced 2.6.6 VAFB LEO Capability data set</li> </ul>
	11	Section 3 <ul style="list-style-type: none"> <li>• Updated Table 3.1.1-1: Gas Conditioning Capabilities</li> <li>• Updated Tables 3.1.2.1-1 through 3.1.2.1-6: C-Band, S-Band and FTS Characteristics</li> <li>• Updated Figure 3.1.2.1-1 400 Series E-Field Radiation</li> <li>• Added Figure 3.1.2.1-2 500 Series E-Field Radiation</li> <li>• Updated Section 3.1.2.3 Launch Range Electromagnetic Environment</li> <li>• Updated Figure Table 3.1.2.3-1 through -4 Worst Case RF Environment</li> <li>• Updated Figure 3.1.2.4-1 E-Field impingement on LV</li> <li>• Section 3.1.2.5.1: Centaur Non-Conductive Material includes previous version Centaur Thermal Blankets and Payload Fairing ESD section.</li> <li>• Updated Figure 3.1.2.5.2-1: Peak Broadband E-field Emissions due to ESD on Centaur</li> <li>• Removed Figure 3.1.2.5.2-2 MIL-STD-1541A Arc Discharge Broadband E-field Emissions</li> <li>• Combined Figure 3.1.2.5.1-1, 3.1.2.5.2-1 and 3.1.2.5.2-2 into new Figure 3.1.2.5.1-1 E-Field Emissions on Centaur</li> <li>• Updated Section 3.2.1 Spacecraft Design Load Factors</li> <li>• Updated Section 3.2.2 Acoustics</li> <li>• Updated Section 3.2.3 Vibration</li> <li>• Updated Section 3.2.4 Shock</li> <li>• Removed Figure 3.2.5-1 FMH Flux Profiles</li> <li>• Added Section 3.2.6.1 Static Pressure Environment Design Considerations</li> <li>• Updated Figure 3.2.7.7-1 CCAM</li> <li>• Added Table 3.3-2 SC Structural Test</li> </ul>



Revision Date	Rev No.	Change Description
		<ul style="list-style-type: none"> <li>Added Section 3.2.7.7.1 Orbital Debris</li> </ul>
	11	<p>Section 4</p> <ul style="list-style-type: none"> <li>Consolidated Rev 10 Section 5 and Appendix C into Rev 11 Section 4</li> <li>Updated typical commercial integration schedule and table</li> <li>Added typical Government integration schedule and table</li> <li>Updated roles and responsibilities of ULA and LMCLS</li> <li>Updated Section 4.4.2: Launch Scheduling Guidelines to redirect users to the ULA Manifest Website for the latest information</li> <li>Updated Spacecraft Information Worksheet</li> </ul>
	11	<p>Section 5</p> <ul style="list-style-type: none"> <li>Consolidated Rev 10 Section 4 and Appendix E into Rev 11 Section 5</li> <li>Updated adapter information in Table 5.1.1-1</li> <li>Updated Figure 5.1.3.1-1: LVA Structural Capability</li> <li>Updated Section 5.1.4.1: Type A937 PLA</li> <li>Added Section 5.1.6: Truss Adapters</li> <li>Updated Section 5.2: SC-to-LV Electrical Interfaces</li> <li>Updated Section 5.4: In-flight Video</li> </ul>
	11	<p>Section 6</p> <ul style="list-style-type: none"> <li>Moved Rev 10 Appendix D and parts of Section 4 to Rev 11 Section 6</li> <li>Reorganized section for clarity</li> </ul>
	11	<p>Section 7</p> <ul style="list-style-type: none"> <li>Consolidated Rev 10 Section 6 and Section 7 into Rev 11 Section 7</li> <li>Reorganized Section 7.1.1 Astrotech facility information and updated Figures and Tables.</li> <li>Added Astrotech URL for latest information.</li> <li>Updated Section 7.1.4: Atlas Spaceflight Operations Center to reflect current facility layout and nomenclature.</li> <li>Updated Section 7.2.1.1 VAFB Astrotech facility to reflect 5-m processing capability and added URL for latest information.</li> <li>Removed NASA SAEF information and figures.</li> <li>Added Figures 7.4-2 and 7.4-3 CCAFS and VAFB Operational Flows</li> <li>Updated Section 7.7.4 and 7.7.4.1 Launch Countdown Operations</li> <li>Updated Figure 7.7.3.6-1: Atlas V Launch Countdown – CCAFS</li> <li>Updated Section 7.9 Weather Launch Constraints</li> <li>Added Table 7.1.1.2-1 Ring Criteria Limit</li> <li>Updated Section 7.10: Launch Postponements to clarify launch abort recycle capabilities.</li> </ul>
	11	<p>Section 8</p> <ul style="list-style-type: none"> <li>Moved all Dual Payload and Auxiliary Payload information to Section 9</li> <li>Moved heavy lift truss section to Section 5</li> <li>Added Section 8.1.1: Longer and Wider Payload Fairings</li> <li>Updated Section 8.2.1: Common Upper Stage</li> <li>Updated Section 8.2.2: Wide-Body Booster</li> <li>Updated Section 8.2.3: Heavy-Lift Evolution</li> <li>Added Section 8.3.1: Centaur Sun Shield</li> </ul>
	11	<p>Section 9</p> <ul style="list-style-type: none"> <li>New section added to capture Auxiliary and Dual Payload Accommodations</li> <li>Auxiliaries include P-POD, ABC, CAP, ESPA, IPC, and XPC</li> <li>Dual Payload Accommodations include DSS, DPC, DPC-S</li> </ul>
	11	<p>Appendices</p> <p>Appendix A</p>

Revision Date	Rev No.	Change Description
		<ul style="list-style-type: none"> <li>• Updated INU references to FTINU.</li> <li>• Updated historical and flight history information to make current</li> <li>• Updated Section A.2.4.1: 400 Series Interstage Adapter</li> <li>• Updated Section A.2.4.2: Centaur Aft Stub Adapter</li> <li>• Removed Figure A.2.3.4.2-1: Electrical System Evolution</li> <li>• Removed Figure A.2.3.4.2-2: Centaur Current Avionics System</li> <li>• Removed Figure A.3-1: Atlas V Manufacturing Road Map</li> <li>• Updated Figure A.3.1-1: Extended Enterprise to represent future state</li> <li>• Updated Figure A.4-1: Atlas/Centaur Reliability to reflect through Atlas V 15th flight.</li> <li>• Added Decatur, AL production facility information</li> <li>• Removed Denver and San Diego production facilities information</li> </ul> <p>Appendix B</p> <ul style="list-style-type: none"> <li>• Changed reference to Product Delivery System to reflect ULA's new Quality Management System</li> <li>• Added new Section B.2: Perfect Product Delivery</li> </ul> <p>Appendix C</p> <ul style="list-style-type: none"> <li>• Merged with Section 4</li> </ul> <p>Appendix D</p> <ul style="list-style-type: none"> <li>• Merged with Section 6</li> </ul> <p>Appendix E</p> <ul style="list-style-type: none"> <li>• Merged with Section 5</li> </ul>

**TABLE OF CONTENTS**

**1. INTRODUCTION AND VEHICLE DESCRIPTION..... 1-1**

1.1 ATLAS V LAUNCH SERVICES USER'S GUIDE..... 1-1

1.2 LAUNCH SERVICES ..... 1-1

1.3 LAUNCH SERVICES ORGANIZATION AND FUNCTION ..... 1-2

1.4 LAUNCH SYSTEM CAPABILITIES AND INTERFACES ..... 1-2

    1.4.1 Atlas V Launch System..... 1-2

    1.4.2 Atlas V Launch System Environments..... 1-3

    1.4.3 Spacecraft and Ground System Interfaces..... 1-4

    1.4.4 Atlas V Mission Integration and Management ..... 1-4

    1.4.5 Spacecraft and Launch Site Facilities..... 1-8

    1.4.6 Atlas V Future Enhancements ..... 1-8

    1.4.7 Auxiliary and Dual Payload Accommodations ..... 1-8

    1.4.8 Supplemental Information ..... 1-9

1.5 ADVANTAGES OF SELECTING UNITED LAUNCH ALLIANCE ..... 1-9

1.6 CONCLUSION ..... 1-9

**2. TRAJECTORY AND PERFORMANCE ..... 2-1**

2.1 MISSION DESCRIPTIONS ..... 2-1

    2.1.1 Direct Ascent Mission (1 Centaur Burn) ..... 2-2

    2.1.2 Parking Orbit Ascent Mission (2 Centaur Burns)..... 2-2

    2.1.3 Park to Transfer Ascent Mission (3 Centaur Burns)..... 2-2

2.2 LV ASCENT DESCRIPTIONS ..... 2-2

    2.2.1 Booster Phase..... 2-2

    2.2.2 Centaur Phase ..... 2-4

2.3 MISSION DESIGN..... 2-5

    2.3.1 Geo-transfer Trajectory and Performance Options ..... 2-5

    2.3.2 Mission Optimization and Geo-transfer Performance Enhancement Options..... 2-9

    2.3.3 Injection Accuracy and Separation Control..... 2-11

2.4 ATLAS V SEQUENCE OF EVENTS ..... 2-16

    2.4.1 Mission Timelines..... 2-16

    2.4.2 Ascent Profiles ..... 2-16

2.5 PERFORMANCE GROUND RULES ..... 2-26

    2.5.1 Payload Systems Weight Definition ..... 2-26

    2.5.2 Payload Fairing Performance Effects ..... 2-27

    2.5.3 LV Performance Confidence Levels ..... 2-27

    2.5.4 Centaur Short Burn Performance Considerations ..... 2-28

    2.5.5 Centaur Coast Performance Considerations ..... 2-28

    2.5.6 Heavy SC Lift Performance Considerations ..... 2-28

2.6 ATLAS V PERFORMANCE CAPABILITY..... 2-29

    2.6.1 Short-Coast Subsynchronous and Supersynchronous Geo-Transfer Capability ..... 2-29

    2.6.2 Short-Coast Standard Geo-transfer with Reduced Inclination Capability..... 2-30

    2.6.3 Minimum Delta-V to Geosynchronous Orbit ( $\Delta V$  to GSO) Performance Data..... 2-30

    2.6.4 Earth-Escape Performance Capability..... 2-30

    2.6.5 CCAFS Low-Earth Orbit Capability..... 2-30

    2.6.6 VAFB LEO Capability..... 2-31

    2.6.7 Intermediate Circular Orbit Capability ..... 2-31

    2.6.8 VAFB Elliptical Orbit Transfer Capability ..... 2-31

    2.6.9 VAFB High-Inclination, High-Eccentricity Orbit Capability ..... 2-31

**3. ENVIRONMENTS..... 3-1**

- 3.1 PRELAUNCH ENVIRONMENTS ..... 3-1
  - 3.1.1 Thermal ..... 3-1
  - 3.1.2 Electromagnetic Compatibility ..... 3-3
  - 3.1.3 Prelaunch Contamination Control and Cleanliness ..... 3-16
- 3.2 LAUNCH AND FLIGHT ENVIRONMENTS ..... 3-19
  - 3.2.1 Spacecraft Design Load Factors ..... 3-19
  - 3.2.2 Acoustics ..... 3-21
  - 3.2.3 Vibration ..... 3-24
  - 3.2.4 Shock ..... 3-25
  - 3.2.5 Thermal ..... 3-27
  - 3.2.6 Static Pressure (PLF Venting) ..... 3-27
  - 3.2.7 In-flight Contamination Control ..... 3-30
  - 3.2.8 Electromagnetic Environment ..... 3-33
- 3.3 SPACECRAFT COMPATIBILITY TEST REQUIREMENTS ..... 3-34
- 4. MISSION INTEGRATION AND SAFETY ..... 4-1**
  - 4.1 INTEGRATION MANAGEMENT ..... 4-1
    - 4.1.1 Launch Vehicle Responsibilities ..... 4-1
    - 4.1.2 Spacecraft Responsibilities ..... 4-1
    - 4.1.3 Mission Management and Integration ..... 4-1
    - 4.1.4 Integration Program Reviews ..... 4-2
    - 4.1.5 Integration Control Documentation ..... 4-4
  - 4.2 MISSION INTEGRATION ANALYSIS ..... 4-5
    - 4.2.1 Coupled Loads Analysis ..... 4-5
    - 4.2.2 Thermal Analyses — Preflight and Flight ..... 4-10
    - 4.2.3 PLF Venting Analysis (Ascent Phase) and Flow Impingement Velocities ..... 4-11
    - 4.2.4 Critical Clearance Analysis (Loss of Clearance) ..... 4-11
    - 4.2.5 Spacecraft Separation Analysis ..... 4-11
    - 4.2.6 Spacecraft Post Separation Clearance Analysis ..... 4-11
    - 4.2.7 Pyroshock Analysis ..... 4-12
    - 4.2.8 Acoustic Analysis ..... 4-12
    - 4.2.9 Launch Vehicle Induced Interface Vibration ..... 4-12
    - 4.2.10 Electromagnetic Interference/Electromagnetic Compatibility Analysis ..... 4-12
    - 4.2.11 Contamination Analysis ..... 4-12
    - 4.2.12 RF Link Compatibility and Telemetry Coverage Analysis (Airborne) ..... 4-12
    - 4.2.13 RF Link Compatibility and Telemetry Coverage Analysis (Ground) ..... 4-13
    - 4.2.14 Performance Analysis ..... 4-13
    - 4.2.15 Stability and Control Analysis ..... 4-13
    - 4.2.16 Mass Properties Analysis ..... 4-13
    - 4.2.17 Trajectory Analysis and Design ..... 4-14
    - 4.2.18 Guidance Analysis ..... 4-14
    - 4.2.19 Injection Accuracy Analysis ..... 4-14
    - 4.2.20 Launch Window Analysis ..... 4-14
    - 4.2.21 Wind Placard Analysis (Prelaunch, Flight) ..... 4-15
    - 4.2.22 Flight Safety Analyses and Data ..... 4-15
    - 4.2.23 End-to-End Electrical Compatibility Analysis ..... 4-15
    - 4.2.24 Postflight Data Analysis ..... 4-15
    - 4.2.25 Destruct System Analysis ..... 4-16
    - 4.2.26 Mission Targeting ..... 4-16
    - 4.2.27 Mission-Unique Flight Software ..... 4-16
  - 4.3 RANGE AND SYSTEM SAFETY INTERFACES ..... 4-17
    - 4.3.1 Requirements and Applicability ..... 4-17
    - 4.3.2 Safety Integration Process ..... 4-18
  - 4.4 POLICIES ..... 4-22
    - 4.4.1 Launch Vehicle Logos ..... 4-22



- 4.4.2 Launch Scheduling Guidelines ..... 4-22
- 4.4.3 Spacecraft Launch Window Options..... 4-22
- 4.5 SPACECRAFT DATA REQUIREMENTS AND CUSTOMER RESPONSIBILITIES..... 4-23
  - 4.5.1 Interface Control Document Inputs ..... 4-23
  - 4.5.2 Spacecraft Design Requirements ..... 4-35
  - 4.5.3 Spacecraft Integration Inputs ..... 4-36
- 5. PAYLOAD INTERFACES ..... 5-1**
  - 5.1 SPACECRAFT-TO-LAUNCH VEHICLE MECHANICAL INTERFACES..... 5-1
    - 5.1.1 Mechanical Interfaces ..... 5-2
    - 5.1.2 Atlas Standard Interface Plane ..... 5-3
    - 5.1.3 Atlas V Launch Vehicle Adapters..... 5-7
    - 5.1.4 Atlas V Standard Payload Adapters..... 5-9
    - 5.1.5 Atlas V Truss Adapters ..... 5-29
  - 5.2 SPACECRAFT-TO-LAUNCH VEHICLE ELECTRICAL INTERFACES ..... 5-30
    - 5.2.1 Umbilical Spacecraft-to-Ground Support Equipment Interface..... 5-32
    - 5.2.2 Electrical In-Flight Disconnects ..... 5-33
    - 5.2.3 Spacecraft Separation System ..... 5-33
    - 5.2.4 Control Command Interface..... 5-33
    - 5.2.5 Spacecraft Environment Instrumentation..... 5-34
    - 5.2.6 Spacecraft Destruct Option..... 5-35
  - 5.3 SPACECRAFT-TO-GROUND EQUIPMENT INTERFACES ..... 5-35
    - 5.3.1 Spacecraft Console..... 5-35
    - 5.3.2 Power ..... 5-35
    - 5.3.3 Liquids and Gases ..... 5-35
    - 5.3.4 Propellant and Gas Sampling ..... 5-36
    - 5.3.5 Work Platforms..... 5-36
  - 5.4 ATLAS V IN-FLIGHT VIDEO OPTION ..... 5-36
- 6. PAYLOAD FAIRINGS ..... 6-1**
  - 6.1 ATLAS V 4-M PAYLOAD FAIRINGS ..... 6-5
    - 6.1.1 Atlas V 4-m Static Payload Envelope ..... 6-9
    - 6.1.2 Payload Compartment Environmental Control ..... 6-16
    - 6.1.3 Payload Access..... 6-17
    - 6.1.4 Payload RF Communications ..... 6-19
    - 6.1.5 Customer Logo..... 6-19
  - 6.2 ATLAS V 5-M PAYLOAD FAIRINGS ..... 6-20
    - 6.2.1 Atlas V 5-m Static Payload Envelope ..... 6-21
    - 6.2.2 Payload Compartment Environmental Control ..... 6-22
    - 6.2.3 5-m PLF Payload Access..... 6-22
    - 6.2.4 Payload RF Communications ..... 6-29
    - 6.2.5 5-m PLF Shielding..... 6-29
    - 6.2.6 Customer Logo..... 6-29
- 7. SPACECRAFT PROCESSING AND LAUNCH OPERATIONS..... 7-1**
  - 7.1 CAPE CANAVERAL AIR FORCE STATION ATLAS V LAUNCH FACILITIES ..... 7-2
    - 7.1.1 CCAFS Spacecraft Processing Facilities..... 7-2
    - 7.1.2 Encapsulated Spacecraft Transport to SLC-41 ..... 7-13
    - 7.1.3 CCAFS Atlas V Launch Site Facilities ..... 7-13
    - 7.1.4 Atlas Spaceflight Operations Center..... 7-19
    - 7.1.5 CCAFS Spacecraft Instrumentation Support Facilities ..... 7-22
  - 7.2 VANDENBERG AIR FORCE BASE ATLAS V LAUNCH FACILITIES..... 7-23

7.2.1 VAFB SPACECRAFT PROCESSING FACILITIES .....	7-23
7.2.2 Spacecraft Encapsulation and Transportation to SLC-3E .....	7-31
7.2.3 Atlas V Space Launch Complex-3E .....	7-32
7.2.4 Remote Launch Control Center .....	7-35
7.3 ADDITIONAL EAST COAST AND WEST COAST FACILITIES .....	7-38
7.3.1 Additional CCAFS Processing Facilities .....	7-38
7.3.2 VAFB Facilities .....	7-39
7.4 VEHICLE INTEGRATION AND SITE PREPARATION .....	7-41
7.4.1 Launch Vehicle and Spacecraft Integration .....	7-43
7.4.2 Standard Launch Services .....	7-44
7.4.3 Propellants, Gases, and Ordnance .....	7-45
7.5 INTEGRATED TEST PLAN .....	7-46
7.6 TEST PROCEDURES .....	7-47
7.7 ATLAS V LAUNCH VEHICLE VERIFICATION TASKS .....	7-47
7.7.1 Factory Tests .....	7-47
7.7.2 Atlas V Launch Site Prelaunch Operations .....	7-47
7.7.3 Atlas V Integrated Operations .....	7-47
7.7.4 Atlas V Launch Countdown Operations .....	7-51
7.8 LAUNCH CAPABILITY .....	7-53
7.9 WEATHER LAUNCH CONSTRAINTS .....	7-53
7.9.1 Operational Weather Constraints .....	7-53
7.9.2 Ground Winds Monitoring .....	7-55
7.9.3 Flight Wind Restrictions .....	7-55
7.10 LAUNCH POSTPONEMENTS .....	7-56
7.10.1 Launch Abort Recycle Capability .....	7-56
7.10.2 Safety COLA Constraints .....	7-56
<b>8. FUTURE ENHANCEMENTS .....</b>	<b>8-1</b>
8.1. PAYLOAD FAIRINGS .....	8-1
8.2 PERFORMANCE UPGRADES .....	8-1
8.2.1 Common Upper-Stage .....	8-1
8.2.2 Wide-Body Booster .....	8-3
8.2.3 Heavy-Lift Evolution .....	8-3
8.3 OTHER ENHANCEMENTS .....	8-4
8.3.1 Centaur Sun Shield .....	8-4
<b>9. AUXILIARY AND DUAL PAYLOAD ACCOMODATIONS .....</b>	<b>9-1</b>
9.1 AUXILIARY PAYLOADS .....	9-1
9.1.2 P-POD .....	9-1
9.1.3 Aft Bulkhead Carrier .....	9-2
9.1.4 C-Adapter Platform .....	9-3
9.1.5 EELV Secondary Payload Adapter .....	9-4
9.1.6 Integrated Payload Carrier .....	9-5
9.1.7 Suborbital Rideshare Concepts .....	9-6
9.2 DUAL PAYLOAD ACCOMMODATIONS .....	9-7
9.2.1 Dual Spacecraft System .....	9-7
9.2.2 Dual Payload Carrier .....	9-12
<b>APPENDIX A — ATLAS HISTORY, VEHICLE DESIGN, AND PRODUCTION .....</b>	<b>A-1</b>
A.1 VEHICLE DEVELOPMENT .....	A-1
A.2 VEHICLE DESIGN .....	A-4
A.2.1 Atlas V Launch Vehicle Major Characteristics .....	A-4
A.2.2 Atlas Booster .....	A-7

A.2.3 Solid Rocket Booster .....A-9  
A.2.4 Atlas V Interstage Adapters .....A-9  
A.2.5 5-Meter Diameter Payload Fairing Boattail Assembly .....A-10  
A.2.6 Centaur Forward Load Reactor .....A-10  
A.2.7 Common Centaur Major Characteristics .....A-10  
A.2.8 Atlas V Payload Fairings .....A-18  
A.2.9 Spacecraft and Launch Vehicle Interface Accommodations .....A-18  
A.3 ATLAS AND CENTAUR PRODUCTION AND INTEGRATION .....A-18  
A.3.1 Organization .....A-18  
A.4 VEHICLE RELIABILITY PREDICTIONS .....A-24  
A.4.1 Vehicle Reliability Growth .....A-25

**APPENDIX B — MISSION SUCCESS, PRODUCT ASSURANCE, AND PERFECT PRODUCT DELIVERY .....B-1**

B.1 QUALITY MANAGEMENT SYSTEM .....B-1  
B.1.1 Quality Assurance .....B-1  
B.1.2 Atlas Launch Operations Product Assurance .....B-6  
B.1.3 Mission Success — Independent Oversight .....B-6  
B.2 PERFECT PRODUCT DELIVERY .....B-8  
B.2.1 Starting with the Customer — the Right Metrics and the Right Behaviors .....B-8  
B.2.2 Making Change Happen — Improving the Business .....B-9

**LIST OF FIGURES**

Figure 1.1-1: The Atlas Team..... 1-1  
Figure 1.4.1-1: Atlas V Launch Vehicle Common System Elements ..... 1-3  
Figure 1.4.1-2: Atlas V Naming Convention ..... 1-4  
Figure 1.4.1-3: Atlas V 400 Series Launch System..... 1-5  
Figure 1.4.1-4: Atlas V 500 Series Launch System..... 1-6  
Figure 1.4.1-5: Atlas V HLV Launch System ..... 1-7  
Figure 1.4.1-6: Atlas V Launch Vehicle Family ..... 1-8

Figure 2.3.1.1-1: Subsynchronous Transfer Orbit Mission Trajectory Profile ..... 2-7  
Figure 2.3.1.2-1: Short-Coast Geosynchronous Transfer Orbit Mission Trajectory Profile ..... 2-7  
Figure 2.3.1.3-1: Supersynchronous Transfer Orbit Mission Trajectory Profile ..... 2-8  
Figure 2.3.1.4-1: Extended Coast Transfer Orbit Mission Trajectory Profile ..... 2-8  
Figure 2.4.2-1: Typical Atlas V 401 Standard Short-Coast GTO Ascent Profile ..... 2-17  
Figure 2.4.2-2: Typical Atlas V 401 Standard LEO Sun-Synchronous Ascent Profile ..... 2-18  
Figure 2.4.2-3: Typical Atlas V 521 Standard Short-Coast GTO Ascent Profile and Ground Trace (1 of 2)..... 2-19  
Figure 2.4.2-3: Typical Atlas V 521 Standard Short-Coast GTO Ascent Profile and Ground Trace (2 of 2)..... 2-20  
Figure 2.4.2-4: Typical Atlas V 521 Extended Coast GSO Ascent Profile and Ground Trace (1 of 2) ..... 2-21  
Figure 2.4.2-4: Typical Atlas V 521 Extended Coast GSO Ascent Profile and Ground Trace (2 of 2) ..... 2-22  
Figure 2.4.2-5: Typical Atlas V 521 3-Burn GSO Ascent Profile (1 of 2)..... 2-23  
Figure 2.4.2-5: Typical Atlas V 521 3-Burn GSO Ground Trace (2 of 2) ..... 2-24  
Figure 2.4.2-6: Typical Atlas HLV GSO Ascent Profile ..... 2-25  
Figure 2.5.1-1: Payload Systems Weight Definition ..... 2-27  
Figure 2.6.1-1: Atlas V 401-431 Apogee Variation Performance to Geo-Transfer Orbit — CCAFS ..... 2-32  
Figure 2.6.1-2: Atlas V 501-551 Apogee Variation Performance to Geo-Transfer Orbit — CCAFS ..... 2-35  
Figure 2.6.2-1: Atlas V 401-431 Reduced Inclination Performance to Geo-Transfer Orbit — CCAFS ..... 2-39  
Figure 2.6.2-2: Atlas V 501-551 Reduced Inclination Performance to Geo-Transfer Orbit — CCAFS ..... 2-42  
Figure 2.6.3-1: Atlas V 401-431 Minimum  $\Delta V$  to Geosynchronous Orbit..... 2-46  
Figure 2.6.3-1a: Atlas V 401 Minimum  $\Delta V$  to Geosynchronous Orbit..... 2-46  
Figure 2.6.3-1b: Atlas V 411 Minimum  $\Delta V$  to Geosynchronous Orbit..... 2-48  
Figure 2.6.3-1c: Atlas V 421 Minimum  $\Delta V$  to Geosynchronous Orbit ..... 2-50  
Figure 2.6.3-1d: Atlas V 431 Minimum  $\Delta V$  to Geosynchronous Orbit..... 2-52  
Figure 2.6.3-2: Atlas V 501-551 Minimum  $\Delta V$  to Geosynchronous Orbit..... 2-54  
Figure 2.6.3-2a: Atlas V 501 Minimum  $\Delta V$  to Geosynchronous Orbit..... 2-54  
Figure 2.6.3-2b: Atlas V 511 Minimum  $\Delta V$  to Geosynchronous Orbit..... 2-56  
Figure 2.6.3-2c: Atlas V 521 Minimum  $\Delta V$  to Geosynchronous Orbit..... 2-58  
Figure 2.6.3-2d: Atlas V 531 Minimum  $\Delta V$  to Geosynchronous Orbit..... 2-60  
Figure 2.6.3-2e: Atlas V 541 Minimum  $\Delta V$  to Geosynchronous Orbit..... 2-62  
Figure 2.6.3-2f: Atlas V 551 Minimum  $\Delta V$  to Geosynchronous Orbit..... 2-64  
Figure 2.6.3-3: Atlas V 521-551 Minimum  $\Delta V$  to Geosynchronous Orbit (3-Burn) ..... 2-66  
Figure 2.6.3-3a: Atlas V 521 Minimum  $\Delta V$  to Geosynchronous Orbit (3-Burn)..... 2-66  
Figure 2.6.3-3b: Atlas V 531 Minimum  $\Delta V$  to Geosynchronous Orbit (3-Burn)..... 2-68  
Figure 2.6.3-3c: Atlas V 541 Minimum  $\Delta V$  to Geosynchronous Orbit (3-Burn)..... 2-70  
Figure 2.6.3-3d: Atlas V 551 Minimum  $\Delta V$  to Geosynchronous Orbit (3-Burn)..... 2-72  
Figure 2.6.5-1: Atlas V 401-431 Low Earth Orbit Performance — CCAFS (28.5 Deg) ..... 2-74  
Figure 2.6.5-1a: Atlas V 401 Low Earth Orbit Performance — CCAFS..... 2-74  
Figure 2.6.5-1b: Atlas V 411 Low Earth Orbit Performance — CCAFS..... 2-76  
Figure 2.6.5-1c: Atlas V 421 Low Earth Orbit Performance — CCAFS..... 2-78  
Figure 2.6.5-1d: Atlas V 431 Low Earth Orbit Performance — CCAFS..... 2-80  
Figure 2.6.5-2: Atlas V 501-551 Low Earth Orbit Performance — CCAFS (28.5 Deg) ..... 2-82  
Figure 2.6.5-2a: Atlas V 501 Low Earth Orbit Performance — CCAFS..... 2-82  
Figure 2.6.5-2b: Atlas V 511 Low Earth Orbit Performance — CCAFS..... 2-84  
Figure 2.6.5-2c: Atlas V 521 Low Earth Orbit Performance — CCAFS..... 2-86  
Figure 2.6.5-2d: Atlas V 531 Low Earth Orbit Performance — CCAFS..... 2-88  
Figure 2.6.5-2e: Atlas V 541 Low Earth Orbit Performance — CCAFS..... 2-90



Figure 2.6.5-2f: Atlas V 551 Low Earth Orbit Performance — CCAFS ..... 2-92  
Figure 2.6.6-1: Atlas V 401-431 Low Earth Orbit Performance — VAFB (90.0 Deg) ..... 2-94  
Figure 2.6.6-1-1: Atlas V 401-431 Low Earth Orbit Performance — VAFB (Sun-Sync) ..... 2-95  
Figure 2.6.6-1a: Atlas V 401 Low Earth Orbit Performance — VAFB ..... 2-96  
Figure 2.6.6-1b: Atlas V 411 Low Earth Orbit Performance — VAFB ..... 2-98  
Figure 2.6.6-1c: Atlas V 421 Low Earth Orbit Performance — VAFB ..... 2-100  
Figure 2.6.6-1d: Atlas V 431 Low Earth Orbit Performance — VAFB ..... 2-102  
Figure 2.6.6-2: Atlas V 501-551 Low Earth Orbit Performance — VAFB (90.0 Deg) ..... 2-104  
Figure 2.6.6-2-1: Atlas V 501-551 Low Earth Orbit Performance — VAFB (Sun-Sync) ..... 2-105  
Figure 2.6.6-2a: Atlas V 501 Low Earth Orbit Performance — VAFB ..... 2-106  
Figure 2.6.6-2b: Atlas V 511 Low Earth Orbit Performance — VAFB ..... 2-108  
Figure 2.6.6-2c: Atlas V 521 Low Earth Orbit Performance — VAFB ..... 2-110  
Figure 2.6.6-2d: Atlas V 531 Low Earth Orbit Performance — VAFB ..... 2-112  
Figure 2.6.6-2e: Atlas V 541 Low Earth Orbit Performance — VAFB ..... 2-114  
Figure 2.6.6-2f: Atlas V 551 Low Earth Orbit Performance — VAFB ..... 2-116

Figure 3.1.1-1: 4-M PLF Environmental Conditioning System ..... 3-3  
Figure 3.1.1-2: 5-M PLF Environmental Conditioning System ..... 3-3  
Figure 3.1.2.1-1: Atlas V 400 Series Launch Vehicle Electric Field Radiation Observed at Top of CFA .... 3-10  
Figure 3.1.2.1-2: Atlas V 500 Series Launch Vehicle Field Radiation Observed at Top of C22 ..... 3-10  
Figure 3.1.2.4-1: Spacecraft Electric Field Radiation Impingement on Launch Vehicle ..... 3-15  
Figure 3.1.2.5.1-1: Peak Broadband E-Field Emissions Due to ESD on Centaur ..... 3-16  
Figure 3.2.1-1: Spacecraft Design Limit Load Factors ..... 3-20  
Figure 3.2.2-1: Max Acoustic Levels for SLC-41 and SLC-3E with Atlas V with 4-M PLF (with Blankets) .. 3-22  
Figure 3.2.2-2: Max Acoustic Levels for SLC-41 Atlas V with 5-M PLF ..... 3-22  
Figure 3.2.2-3: Acoustic Levels Near Vents for 4-M Payload Fairings ..... 3-24  
Figure 3.2.3-1: Quasi-Sinusoidal Vibration Levels for Atlas V 400 Series and Atlas V 500 Series  
Based On SRS with Q=20 ..... 3-25  
Figure 3.2.4-1: Typical Maximum Atlas Shock Levels – Atlas V Standard Payload Adapters ..... 3-26  
Figure 3.2.4-2: Maximum Allowable Spacecraft-Produced Shock at Centaur Forward Adapter and the Top of  
the LV Adapter ..... 3-26  
Figure 3.2.6-1: Typical Static Pressure Profiles Inside the EPF for Atlas V 431 ..... 3-28  
Figure 3.2.6-2: Typical Payload Compartment Pressure Decay Rate Inside the EPF for Atlas V 431 ..... 3-28  
Figure 3.2.6-3: Typical Static Pressure Profiles Inside the 5-M Fairing ..... 3-29  
Figure 3.2.6-4: Typical Payload Compartment Pressure Decay Rate for the 5-M Fairing ..... 3-29  
Figure 3.2.6.1-1: Atlas V Design Time Pressure History Curves ..... 3-30  
Figure 3.2.7.7-1: Typical Spacecraft Motion Relative to Centaur ..... 3-33  
Figure 3.2.7.8-1: Typical Spacecraft Impingement Fluxes During Propellant Tank Blow Down ..... 3-34

Figure 4.2-1: Twenty-Four Month Generic Commercial Mission Integration Schedule ..... 4-6  
Figure 4.2-2: Twenty-Four Month Generic Government Mission Integration Schedule ..... 4-7  
Figure 4.3.2-1: Atlas V Safety Integration Process ..... 4-20

Figure 5.1-1: Atlas V Payload Interface Options ..... 5-1  
Figure 5.1.2-1: Atlas V Standard Interface Plane ..... 5-3  
Figure 5.1.2.1-1: Atlas V Standard Interface Plane Structural Capability (1,575-mm [62.010-In.]  
Bolt Circle Dia. Interface) ..... 5-4  
Figure 5.1.2.2-1: Atlas V Standard Interface Plane Dimensional Requirements ..... 5-5  
Figure 5.1.2.3-1: Atlas V Standard Interface Plane Static Payload Envelope ..... 5-6  
Figure 5.1.3-1: Atlas V Launch Vehicle Adapter Configuration ..... 5-7  
Figure 5.1.3.1-1: Atlas Launch Vehicle Adapter Structural Capability ..... 5-8  
Figure 5.1.3.2-1: Atlas Launch Vehicle Adapter Interface Requirements ..... 5-9  
Figure 5.1.4-1: Atlas V Standard Payload Adapter Configuration — PSR with LV Adapter ..... 5-10  
Figure 5.1.4.1-1: Atlas V Low-Shock Payload Separation System Configuration ..... 5-11  
Figure 5.1.4.2-1: Atlas V Type A937 Payload Adapter ..... 5-12  
Figure 5.1.4.2.2-1: Atlas Type A937 Payload Adapter Structural Capability ..... 5-12

Figure 5.1.4.2.3-1: Spacecraft Interface Requirements for Atlas V Type A937 PSR..... 5-14  
Figure 5.1.4.2.3-2: Atlas V Type A937 PSR Interface Requirements ..... 5-15  
Figure 5.1.4.2.4-1: Atlas V Type A937 Payload Adapter Static Payload Envelope ..... 5-16  
Figure 5.1.4.3-1: Atlas V Type B1194 Payload Adapter..... 5-18  
Figure 5.1.4.3.2-1: Atlas Type B1194 Payload Adapter Structural Capability ..... 5-19  
Figure 5.1.4.3.3-1: Spacecraft Interface Requirements for Atlas V Type B1194 PSR..... 5-20  
Figure 5.1.4.3.3-2: Atlas V Type B1194 PSR Interface Requirements ..... 5-21  
Figure 5.1.4.3.4-1: Atlas V Type B1194 Payload Adapter Static Payload Envelope ..... 5-22  
Figure 5.1.4.4-1: Atlas V Type D1666 Payload Adapter ..... 5-24  
Figure 5.1.4.4.2-1: Atlas V Type D1666 Payload Adapter Structural Capability ..... 5-25  
Figure 5.1.4.4.3-1: Spacecraft Interface Requirements for Atlas V Type D1666 PSR ..... 5-26  
Figure 5.1.4.4.3-2: Atlas V Type D1666 Payload Adapter Interface Requirements..... 5-27  
Figure 5.1.4.4.4-1: Atlas V Type D1666 Payload Adapter Static Payload Envelope ..... 5-28  
Figure 5.1.5.1-1: T4394 Truss Adapter ..... 5-29  
Figure 5.1.5.2-1: T3302 Truss Adapter ..... 5-30  
Figure 5.2-1: Typical Spacecraft/Launch Vehicle Electrical Interface..... 5-31  
Figure 5.2-2: Spacecraft Switch Interface Schematic ..... 5-32  
Figure 5.4-1: Atlas Launch Vehicle In-Flight Video Image — Solid Rocket Booster Separation ..... 5-37  
Figure 5.4-2: Atlas Launch Vehicle In-Flight Video Image — Payload Fairing Separation..... 5-37

Figure 6-1: Atlas V Payload Fairings ..... 6-1  
Figure 6-2: Atlas V Vehicle Lengths with Payload Fairing Options ..... 6-2  
Figure 6-3: Atlas V 4-m Simplified Static Payload Envelopes ..... 6-3  
Figure 6-4: Atlas V 5-m Simplified Static Payload Envelopes ..... 6-4  
Figure 6.1-1: Atlas V 4-m Payload Fairing Interface Features ..... 6-5  
Figure 6.1-2: Atlas V 4-m Large Payload Fairing ..... 6-6  
Figure 6.1-3: Atlas V 4-m Extended Payload Fairing ..... 6-7  
Figure 6.1-4: Atlas V 4-m Extra Extended Payload Fairing..... 6-8  
Figure 6.1.1-1: Atlas V 4-m PLF Static Payload Envelope, 3,850-mm Diameter..... 6-9  
Figure 6.1.1-2: Atlas V 4-m Isometric Views of the PLF Static Payload Envelope ..... 6-10  
Figure 6.1.1-3: Atlas V 4-m LPF Static Payload Envelope ..... 6-11  
Figure 6.1.1-4: Atlas V 4-m EPF Static Payload Envelope ..... 6-12  
Figure 6.1.1-5: Atlas V 4-m XEPF Static Payload Envelope ..... 6-13  
Figure 6.1.1-6: Atlas V 4-m LPF, EPF, XEPF Static Payload Envelope Common Views (1 of 2) ..... 6-14  
Figure 6.1.1-6: Atlas V 4-m LPF, EPF, XEPF Static Payload Envelope Common Views (2 of 2) ..... 6-15  
Figure 6.1.2-1: Atlas V 4-m PLF Acoustic Panels ..... 6-16  
Figure 6.1.2-2: Atlas V 4-m PLF Thermal Shields..... 6-17  
Figure 6.1.3-1: Atlas V 4-m PLF Access Doors..... 6-18  
Figure 6.1.4-1: Atlas V 4-m PLF RF Reradiate Antenna Installation..... 6-19  
Figure 6.1.5-1: Atlas V 4-m PLF Customer Logo Provisions ..... 6-19  
Figure 6.2-1: Atlas V 5-Meter Payload Fairing Configuration..... 6-20  
Figure 6.2-2: Atlas V 5-m Payload Fairing Interface Features ..... 6-21  
Figure 6.2.2-1: Atlas V 5-m Fairing Acoustic Protection ..... 6-22  
Figure 6.2.3-1: Atlas V 5-m Short PLF Mission Specific Access Door Allowable Locations (1 of 2) ..... 6-23  
Figure 6.2.3-1: Atlas V 5-m Short PLF Mission Specific Access Door Allowable Locations (2 of 2) ..... 6-24  
Figure 6.2.3-2: Atlas V 5-m Medium PLF Mission Specific Access Door Allowable Locations (1 of 2)..... 6-25  
Figure 6.2.3-2: Atlas V 5-m Medium PLF Mission Specific Access Door Allowable Locations (2 of 2)..... 6-26  
Figure 6.2.3-3: Atlas V 5-m Long PLF Mission Specific Access Door Allowable Locations (1 of 2)..... 6-27  
Figure 6.2.3-3: Atlas V 5-m Long PLF Mission Specific Access Door Allowable Locations (2 of 2)..... 6-28  
Figure 6.2.6-1: Atlas V 5-m Customer Logo Provisions ..... 6-29

Figure 7.1-1: Atlas V CCAFS Launches ..... 7-1  
Figure 7.1-2: Atlas V VAFB Launch..... 7-2  
Figure 7.1.1-1: Facility Locations at or Near CCAFS ..... 7-3  
Figure 7.1.1-2: Astrotech Facility ..... 7-4  
Figure 7.1.1-3: Astrotech Building 1 ..... 7-4

Figure 7.1.1-4: Astrotech Building 1 Detailed Floor Plan ..... 7-5  
Figure 7.1.1-5: Astrotech Building 2 Hazardous Operations Facility ..... 7-8  
Figure 7.1.1-6: Astrotech Building 9 Layout ..... 7-11  
Figure 7.1.3.1-1: Vertical Integration Facility ..... 7-14  
Figure 7.1.3.2-1: Payload Van ..... 7-16  
Figure 7.1.3.2-2: Communications Network ..... 7-17  
Figure 7.1.3.3-1: Mobile Launch Platform ..... 7-18  
Figure 7.1.3.4-1: Space Launch Complex 41 ..... 7-19  
Figure 7.1.4-1: ASOC Launch Operations Center First Floor ..... 7-20  
Figure 7.1.4-2: ASOC Launch Operations Center Second Floor ..... 7-21  
Figure 7.2.1-1: VAFB Facility Locations ..... 7-23  
Figure 7.2.1.1-1: Astrotech/VAFB Payload Processing Facility Layout ..... 7-25  
Figure 7.2.1.1-2: Technical Support Building ..... 7-26  
Figure 7.2.1.2-1: Integrated Processing Facility ..... 7-27  
Figure 7.2.1.2-2: IPF Floor Plan ..... 7-29  
Figure 7.2.1.2-3: IPF Side View ..... 7-30  
Figure 7.2.3-1: SLC-3E Available Launch Azimuths ..... 7-32  
Figure 7.2.3-2: Space Launch Complex 3-East First Atlas V Launch ..... 7-33  
Figure 7.2.3.1-2: SLC-3E Atlas V to MST Relationship ..... 7-34  
Figure 7.2.3.5-1: Launch Services Building Spacecraft User's Room 219 ..... 7-36  
Figure 7.2.4-1: Atlas RLCC Area within Building 8510 ..... 7-37  
Figure 7.3.1.2.1-1: CCAFS Spacecraft Processing Facilities ..... 7-39  
Figure 7.3.1.2.1-2: DPF Area Detail Site Plan ..... 7-40  
Figure 7.4-1: Typical Factory-To-Launch Operations ..... 7-41  
Figure 7.4-2 CCAFS Operational Flow ..... 7-42  
Figure 7.4-3 VAFB Operational Flow ..... 7-42  
Figure 7.5-1: Integrated Test Plan Organization ..... 7-46  
Figure 7.7.2-1: 4-M Payload Fairing Mate and Spacecraft Encapsulation (5-M Process Is Similar) ..... 7-48  
Figure 7.7.3.4-1: Integrated System Test Flow ..... 7-50  
Figure 7.7.3.6-1: Atlas V Launch Countdown — CCAFS ..... 7-52  
Figure 7.7.3.6-2: Atlas V Launch Countdown — VAFB ..... 7-52  
Figure 7.7.4-1: Typical Atlas V Launch Day Management Flow Diagram ..... 7-53

Figure 8.1-1: Atlas V with 7.2-M Diameter, 32.3-M Long PLF ..... 8-1  
Figure 8.2.1-1: Common Upper Stage Concept (Dual Engine) ..... 8-2  
Figure 8.2.2-1: Atlas V Wide-Body Booster ..... 8-3  
Figure 8.2.3-1: Heavy-Lift Evolution ..... 8-4  
Figure 8.3.1-1: Centaur Sun Shield Concept of Operations ..... 8-5

Figure 9.1-1: Atlas V Rideshare Accommodations ..... 9-1  
Figure 9.1.2-1: NPSCul with Eight PPODs ..... 9-2  
Figure 9.1.3-1: ABC Mounting Location ..... 9-2  
Figure 9.1.3-2: ABC Usable Volume (Separating Payload) ..... 9-3  
Figure 9.1.4-1: CAP Location and Volume ..... 9-3  
Figure 9.1.4-2: Four CAPS Attached to C-Adapter ..... 9-3  
Figure 9.1.5-1: Typical Atlas ESPA and C-Adapter Structural Stack ..... 9-4  
Figure 9.1.5-2: APL Envelope Definition ..... 9-4  
Figure 9.1.6-1: IPC Stack Options ..... 9-5  
Figure 9.1.6-2: IPC Internal Configurations ..... 9-6  
Figure 9.1.7: External Payload Carrier ..... 9-6  
Figure 9.2.1-1: Dual Spacecraft System ..... 9-7  
Figure 9.2.1-2: Centaur Forward Adapter Assembly ..... 9-8  
Figure 9.2.1-3: Preliminary DSS Payload Envelope — 4-M XEPF with No DSS Plugs ..... 9-9  
Figure 9.2.1-4: Preliminary DSS Payload Envelope — 4-M XEPF with One DSS Plug ..... 9-9  
Figure 9.2.1-5: Preliminary DSS Payload Envelope — 4-M XEPF with Two DSS Plugs ..... 9-10  
Figure 9.2.1-6: Preliminary DSS Payload Envelope — 4-M XEPF with Three DSS Plugs ..... 9-10

Figure 9.2.1-7: Preliminary DSS Payload Envelope — 4-M X XEPF with Four DSS Plugs ..... 9-11  
Figure 9.2.1-8: DSS Concept ff Operations..... 9-11  
Figure 9.2.2-1: Atlas V 500 Series Dual Payload Carrier ..... 9-12  
Figure 9.2.2-2: Dual Payload Carrier — Preliminary Payload Envelopes ..... 9-13  
Figure 9.2.2.1-1: Dual Payload Carrier — Short — Preliminary Payload Envelopes..... 9-14

Figure A.1-1: Atlas Launch Vehicle Successful Evolution..... A-2  
Figure A.1-2: Atlas V Configurations and Performance Evolution ..... A-3  
Figure A.1-3: Centaur Evolution Accommodates Boost Vehicle Performance and Reliability..... A-4  
Figure A.2.1-1: Atlas V 400 Series Launch Vehicle ..... A-5  
Figure A.2.1-2: Atlas V 500 Series Launch Vehicle ..... A-6  
Figure A.2.1-3: Atlas V HLV Launch Vehicle..... A-6  
Figure A.2.2.1-1: Atlas Booster Components..... A-8  
Figure A.2.2.3-1: RD-180 Engine Schematic ..... A-9  
Figure A.2.7.1-1: Monocoque Centaur Tank ..... A-11  
Figure A.2.7.1-2: Centaur Forward Adapter Interface ..... A-11  
Figure A.2.7.1-3: Centaur Forward Adapter Avionics ..... A-11  
Figure A.2.7.1-4: Centaur Tank Fixed Foam Insulator ..... A-12  
Figure A.2.7.3-1: RL10A-4-2 Engine ..... A-12  
Figure A.2.7.3-2: Atlas V Dual Engine Centaur Propulsion System..... A-13  
Figure A.2.7.3-3: Atlas V Single Engine Centaur Propulsion System ..... A-14  
Figure A.2.7.4.2-1: Centaur Fault Tolerant Avionics System ..... A-16  
Figure A.2.7.4.2-2: Telemetry Data Acquisition System Configuration ..... A-17  
Figure A.2.3.4.2-3: Centaur SFTS Configuration ..... A-19  
Figure A.3.1-1: Extended Enterprise ..... A-19  
Figure A.3.1.1-1: Harlingen Operations..... A-20  
Figure A.3.1.3-2: Harlingen Key Process ..... A-20  
Figure A.3.1.3-3: Harlingen Production ..... A-21  
Figure A.3.1.2-1: Decatur Operations ..... A-22  
Figure A.3.1.2-2: Decatur Production ..... A-23  
Figure A.4-1: Atlas/Centaur Reliability (Duane Reliability Growth Method) Through Atlas V 15th Flight .... A-25

Figure B.1.1-1: Detailed Corrective Action Process ..... B-2  
Figure B.1.1-2: Systemic Corrective Action Process..... B-2  
Figure B.1.1-3: Preventive Action Process..... B-3  
Figure B.1.3-1: Mission Success Acceptance Process..... B-7



LIST OF TABLES

Table 2.3.1-1: Geo-Transfer Option Benefits (Example Comparison) ..... 2-9

Table 2.3.2.2-1: Atlas V Perigee Velocity Variations with MRS ..... 2-10

Table 2.3.3-1: Typical Injection Accuracies at SC Separation ..... 2-12

Table 2.3.3-2: Injection Accuracy Results for IFR, MRS, and IFR/MRS Missions ..... 2-12

Table 2.3.3-3: Injection Accuracy Results for GCS Missions ..... 2-13

Table 2.3.3.2-1: Guidance and Control Capabilities Summary ..... 2-14

Table 2.3.3.2-2: Design Range of Payload Mass Properties ..... 2-15

Table 2.4.1-1: Typical Atlas V LV Mission Sequence Timeline ..... 2-16

Table 2.5.1-1: Performance Effects of SC Required Hardware ..... 2-26

Table 2.6.1: Atlas V 400/500 Series and HLV Performance Capabilities Summary ..... 2-29

Table 2.6.1-1: Atlas V 401-431 Geo-Transfer Orbit Performance — PSW vs Apogee Altitude (1 of 2) ..... 2-33

Table 2.6.1-1: Atlas V 401-431 Geo-Transfer Orbit Performance — PSW vs Apogee Altitude (2 of 2) ..... 2-34

Table 2.6.1-2: Atlas V 501-551 Geo-Transfer Orbit Performance — PSW vs Apogee Altitude (1 of 3) ..... 2-36

Table 2.6.1-2: Atlas V 501-551 Geo-Transfer Orbit Performance — PSW vs Apogee Altitude (2 of 3) ..... 2-37

Table 2.6.1-2: Atlas V 501-551 Geo-Transfer Orbit Performance — PSW vs Apogee Altitude (3 of 3) ..... 2-38

Table 2.6.2-1: Atlas V 401-431 Geo-Transfer Orbit Performance — PSW vs Orbit Inclination (1 of 2) ..... 2-40

Table 2.6.2-1: Atlas V 401-431 Geo-Transfer Orbit Performance — PSW vs Orbit Inclination (2 of 2) ..... 2-41

Table 2.6.2-2: Atlas V 501-551 Geo-Transfer Orbit Performance — PSW vs Orbit Inclination (1 of 3) ..... 2-43

Table 2.6.2-2: Atlas V 501-551 Geo-Transfer Orbit Performance — PSW vs Orbit Inclination (2 of 3) ..... 2-44

Table 2.6.2-2: Atlas V 501-551 Geo-Transfer Orbit Performance — PSW vs Orbit Inclination (3 of 3) ..... 2-45

Table 2.6.3-1a: Atlas V 401 Minimum  $\Delta V$  to Geosynchronous Orbit — Apogee Cap ..... 2-47

Table 2.6.3-1b: Atlas V 411 Minimum  $\Delta V$  to Geosynchronous Orbit — Apogee Cap ..... 2-49

Table 2.6.3-1c: Atlas V 421 Minimum  $\Delta V$  to Geosynchronous Orbit — Apogee Cap ..... 2-51

Table 2.6.3-1d: Atlas V 431 Minimum  $\Delta V$  to Geosynchronous Orbit — Apogee Cap ..... 2-53

Table 2.6.3-2a: Atlas V 501 Minimum  $\Delta V$  to Geosynchronous Orbit — Apogee Cap ..... 2-55

Table 2.6.3-2b: Atlas V 511 Minimum  $\Delta V$  to Geosynchronous Orbit — Apogee Cap ..... 2-57

Table 2.6.3-2c: Atlas V 521 Minimum  $\Delta V$  to Geosynchronous Orbit — Apogee Cap ..... 2-59

Table 2.6.3-2d: Atlas V 531 Minimum  $\Delta V$  to Geosynchronous Orbit — Apogee Cap ..... 2-61

Table 2.6.3-2e: Atlas V 541 Minimum  $\Delta V$  to Geosynchronous Orbit — Apogee Cap ..... 2-63

Table 2.6.3-2f: Atlas V 551 Minimum  $\Delta V$  to Geosynchronous Orbit — Apogee Cap ..... 2-65

Table 2.6.3-3a: Atlas V 521 Minimum  $\Delta V$  to Geosynchronous Orbit (3 Burn) — Apogee Cap ..... 2-67

Table 2.6.3-3b: Atlas V 531 Minimum  $\Delta V$  to Geosynchronous Orbit (3 Burn) — Apogee Cap ..... 2-69

Table 2.6.3-3c: Atlas V 541 Minimum  $\Delta V$  to Geosynchronous Orbit (3 Burn) — Apogee Cap ..... 2-71

Table 2.6.3-3d: Atlas V 551 Minimum  $\Delta V$  to Geosynchronous Orbit (3 Burn) — Apogee Cap ..... 2-73

Table 2.6.5-1a: Atlas V 401 Low Earth Orbit Performance — PSW vs Altitude ..... 2-75

Table 2.6.5-1b: Atlas V 411 Low Earth Orbit Performance — PSW vs Altitude ..... 2-77

Table 2.6.5-1c: Atlas V 421 Low Earth Orbit Performance — PSW vs Altitude ..... 2-79

Table 2.6.5-1d: Atlas V 431 Low Earth Orbit Performance — PSW vs Altitude ..... 2-81

Table 2.6.5-2a: Atlas V 501 Low Earth Orbit Performance — PSW vs Altitude ..... 2-83

Table 2.6.5-2b: Atlas V 511 Low Earth Orbit Performance — PSW vs Altitude ..... 2-85

Table 2.6.5-2c: Atlas V 521 Low Earth Orbit Performance — PSW vs Altitude ..... 2-87

Table 2.6.5-2d: Atlas V 531 Low Earth Orbit Performance — PSW vs Altitude ..... 2-89

Table 2.6.5-2e: Atlas V 541 Low Earth Orbit Performance — PSW vs Altitude ..... 2-91

Table 2.6.5-2f: Atlas V 551 Low Earth Orbit Performance — PSW vs Altitude ..... 2-93

Table 2.6.6-1a: Atlas V 401 Low Earth Orbit Performance — PSW vs Altitude (VAFB) ..... 2-97

Table 2.6.6-1b: Atlas V 411 Low Earth Orbit Performance — PSW vs Altitude (VAFB) ..... 2-99

Table 2.6.6-1c: Atlas V 421 Low Earth Orbit Performance — PSW vs Altitude (VAFB) ..... 2-101

Table 2.6.6-1d: Atlas V 431 Low Earth Orbit Performance — PSW vs Altitude (VAFB) ..... 2-103

Table 2.6.6-2a: Atlas V 501 Low Earth Orbit Performance — PSW vs Altitude ..... 2-107

Table 2.6.6-2b: Atlas V 511 Low Earth Orbit Performance — PSW vs Altitude ..... 2-109

Table 2.6.6-2c: Atlas V 521 Low Earth Orbit Performance — PSW vs Altitude ..... 2-111

Table 2.6.6-2d: Atlas V 531 Low Earth Orbit Performance — PSW vs Altitude ..... 2-113

Table 2.6.6-2e: Atlas V 541 Low Earth Orbit Performance — PSW vs Altitude ..... 2-115

Table 2.6.6-2f: Atlas V 551 Low Earth Orbit Performance — PSW vs Altitude ..... 2-117

Table 3.1.1-1: Atlas V Gas Conditioning Capabilities..... 3-2  
Table 3.1.1-2: Conditioned Air/Gn2 Characteristics ..... 3-2  
Table 3.1.2.1-1: Atlas V 400 Series C-Band Transponder and RF Characteristics ..... 3-4  
Table 3.1.2.1-2: Atlas V 400 Series S-Band Transmitter and RF Characteristics ..... 3-5  
Table 3.1.2.1-3: Atlas V 400 Flight Termination System Receiver and RF Characteristics ..... 3-6  
Table 3.1.2.1-4: Atlas V 500 Series C-Band Transponder and RF Characteristics ..... 3-7  
Table 3.1.2.1-5: Atlas V 500 Series S-Band Transmitter and RF Characteristics ..... 3-8  
Table 3.1.2.1-6: Atlas V 500 Series Flight Termination System (FTS) Receiver and RF Characteristics ..... 3-9  
Table 3.1.2.3-1: Worst-Case (Peak) RF Environment During Transport From Astrotech  
Spaceflight Operations to SLC-41 ..... 3-12  
Table 3.1.2.3-2: Worst-Case (Peak) RF Environment at SLC -41 ..... 3-13  
Table 3.1.2.3-3: Worst-Case (Peak) RF Environment During Transport From IPF to SLC-3E ..... 3-14  
Table 3.1.2.3-4: Worst-Case (Peak) RF Environment for VAFB SLC-3E ..... 3-14  
Table 3.2.1-1: Spacecraft Design Limit Load Factors ..... 3-20  
Table 3.2.2-1: Max Acoustic Levels for SLC-41 and SLC-3E Atlas V with 4-M PLF (with Blankets)..... 3-21  
Table 3.2.2-2: Max Acoustic Levels for Atlas V with 5-M PLF ..... 3-23  
Table 3.2.6.1-1: Atlas V Design Time Pressure History Data Points ..... 3-31  
Table 3.3-1: Spacecraft Structural Tests, Margins, and Durations ..... 3-34  
Table 3.3-2: Spacecraft Qualification and Acceptance Test Requirements ..... 3-35

Table 4.2-1: Summary of Typical Commercial and Government Atlas V Mission Integration Analyses ..... 4-8  
Table 4.5.1-1: Spacecraft Information Worksheet (1 of 6) ..... 4-24  
Table 4.5.1-1: Spacecraft Information Worksheet (2 of 6) ..... 4-25  
Table 4.5.1-1: Spacecraft Information Worksheet (3 of 6) ..... 4-26  
Table 4.5.1-1: Spacecraft Information Worksheet (4 of 6) ..... 4-27  
Table 4.5.1-1: Spacecraft Information Worksheet (5 of 6) ..... 4-28  
Table 4.5.1-1: Spacecraft Information Worksheet (6 of 6) ..... 4-29  
Table 4.5.1-2: Mission Requirements ..... 4-30  
Table 4.5.1-3: Spacecraft Characteristics (1 of 2) ..... 4-31  
Table 4.5.1-3: Spacecraft Characteristics (2 of 2) ..... 4-32  
Table 4.5.1-4: Interface Requirements (Mechanical) (1 of 2) ..... 4-32  
Table 4.5.1-4: Interface Requirements (Mechanical) (2 of 2) ..... 4-33  
Table 4.5.1-5: Interface Requirements (Electrical) (1 of 2) ..... 4-33  
Table 4.5.1-5: Interface Requirements (Electrical) (2 of 2) ..... 4-34  
Table 4.5.1-6: Test And Launch Operations (1 of 2) ..... 4-34  
Table 4.5.1-6: Test And Launch Operations (2 of 2) ..... 4-35  
Table 4.5.1-7: Ground Equipment and Facility Requirements (Electrical) ..... 4-36  
Table 4.5.2-1: Spacecraft Design Elements to Be Certified by Analysis or Test (1 of 2) ..... 4-36  
Table 4.5.2-1: Spacecraft Design Elements to be Certified by Analysis or Test (2 of 2) ..... 4-37  
Table 4.5.3-1: Spacecraft Inputs to Integration Process (1 of 2) ..... 4-37  
Table 4.5.3-1: Spacecraft Inputs to Integration Process (2 of 2) ..... 4-38

Table 5.1.1-1: Atlas V Payload Support Interface Options ..... 5-2  
Table 5.1.3-1: Atlas V Adapters ..... 5-7  
Table 5.1.4.2-1: Atlas V Type A937 Payload Adapter Characteristics ..... 5-12  
Table 5.1.4.3-1: Atlas V Type B1194 Payload Adapter Characteristics ..... 5-17  
Table 5.1.4.4-1: Atlas V Type D1666 Payload Adapter Characteristics ..... 5-23  
Table 5.2.1.1-1: Payload Circuit Current Limits ..... 5-33  
Table 5.4-1: Atlas Launch Vehicle In-Flight Video Missions ..... 5-36

Table 7.1.1-1: Astrotech Building 1 – Payload Processing Facility ..... 7-6  
Table 7.1.1-2: Astrotech Building 2 – Three Blast-Proof Processing Rooms ..... 7-7  
Table 7.1.1-3: Astrotech Building 3 – Short Term Spacecraft Storage ..... 7-9  
Table 7.1.1-4: Astrotech Building 4 – Warehouse Storage Area ..... 7-9  
Table 7.1.1-5: Astrotech Building 9 – Two Processing Rooms ..... 7-12  
Table 7.1.3.1-1: Vertical Integration Facility Spacecraft Accommodations ..... 7-14

Table 7.3.1.1.2-1: NASA PHSF Building – Hazardous Processing Facility ..... 7-38  
Table 7.4.3-1: Hypergolic Propellants — CCAFS Fuel Storage Depot..... 7-45  
Table 7.9.1.2-1: Ring Criteria Limit..... 7-55  
Table 7.10.1-1: Launch Abort Recycle Capability ..... 7-16

Table 8.2.1-1: Common Upper Stage (Dual-Engine) 90,000 lb Propellant Load Performance ..... 8-2

Table A.4-1: Typical Atlas V Reliability Predictions — GTO Mission Profile.....A-24  
Table A.1-1: Atlas/Centaur Launch History .....A-27

Intentionally Left Blank



## 1. INTRODUCTION AND VEHICLE DESCRIPTION

United Launch Alliance (ULA) was formed on December 1, 2006 as a joint venture between The Boeing Company and Lockheed Martin Corporation (LMC). ULA was created to provide reliable, cost-efficient spacecraft launch services for the U.S. government and commercial customers.

ULA brings together two of the launch industry's most experienced and successful teams that have supported America's presence in space for more than 50 years. Atlas and Delta launch vehicles have carried over 850 payloads into space ranging from weather, telecommunications, and national security satellites that protect and improve life on Earth, to deep space and interplanetary exploration missions that further our knowledge of the universe.

Under ULA, Delta and Atlas rockets provide safe, cost-efficient, readily available and reliable access to space for U.S. government and commercial missions, continuing the tradition of supporting strategic U.S. space initiatives with advanced, robust launch solutions.

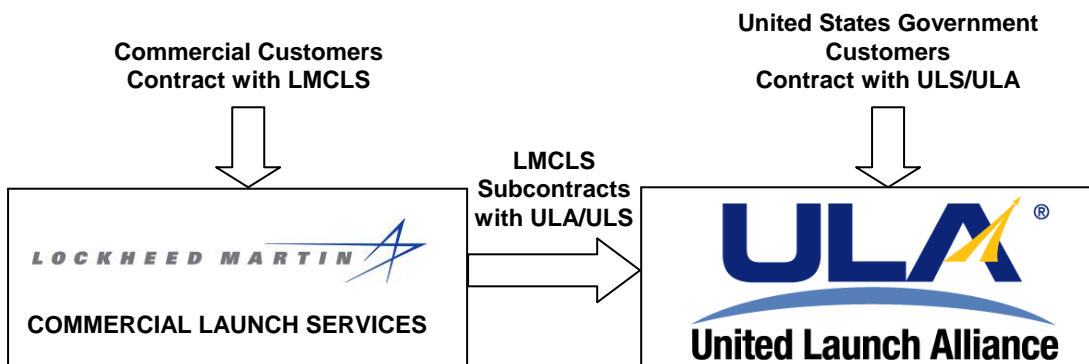
### 1.1 ATLAS V LAUNCH SERVICES USER'S GUIDE

This *Atlas V Launch Services User's Guide* (AVUG) provides current and potential Atlas V launch services customers with information about the Atlas V launch vehicle family and related spacecraft services. The Atlas family of launch vehicles has a long-established heritage and a record of unsurpassed reliability and performance over a span of 50 years. The Atlas I, II, IIA, IIAS, and Atlas III configurations have completed their life cycles and have been superseded by the Atlas V 400 and 500 series. A full range of technical planning data and requirements are included in this guide to allow the user to assess the compatibility of the user's spacecraft with various interfaces that comprise the Atlas V launch vehicle system.

### 1.2 LAUNCH SERVICES

Atlas V launch services are offered to commercial customers by contracting with Lockheed Martin Commercial Launch Services (LMCLS), a wholly owned subsidiary of LMC. United States Government customers contract directly with United Launch Services, L.L.C. (ULS). ULS is a subsidiary and the contracting agent of ULA.

Figure 1.1-1: The Atlas Team



### 1.3 LAUNCH SERVICES ORGANIZATION AND FUNCTION

Atlas V Launch Services User's Guide addresses the full range of spacecraft integration, processing, encapsulation, launch operations, and verification of the orbit. The typical launch service includes:

1. Launch operations services
2. Mission Integration
3. Mission-unique hardware and software design, test, and production
4. Launch vehicle/spacecraft and interface design
5. Mission management
6. Program management
7. Launch facilities and support provisions
8. Payload processing facilities
9. Spacecraft support at the launch site
10. Validation of spacecraft separation sequence and orbit
11. Range Safety interface
12. Customer launch event support
13. Launch and export licensing, as applicable

### 1.4 LAUNCH SYSTEM CAPABILITIES AND INTERFACES

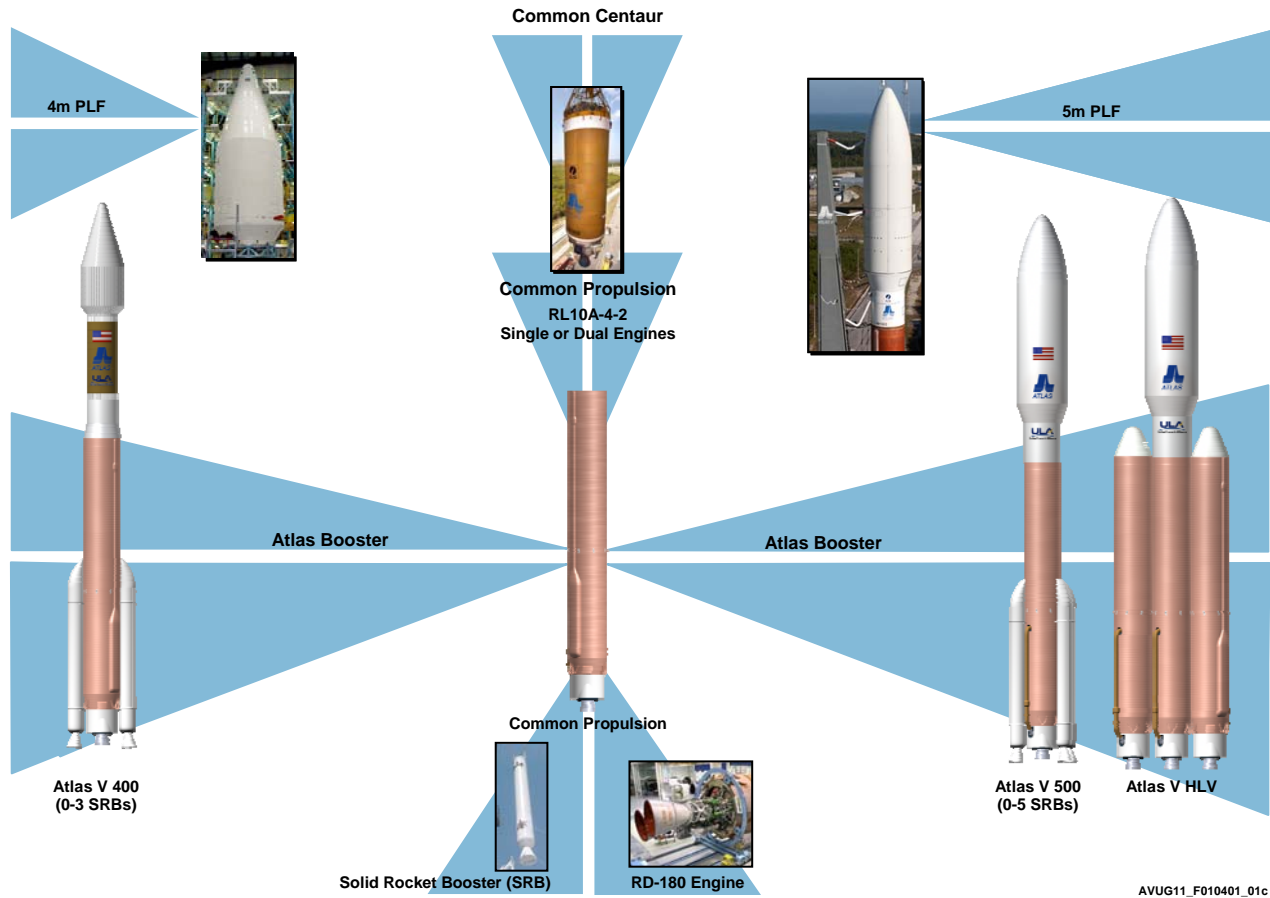
From the user's perspective, the Atlas V launch system comprises a number of hardware and software subsystems and engineering, manufacturing, and operations processes designed to integrate the spacecraft with the launch vehicle. The following paragraphs summarize the major interface and process components of the Atlas V launch system. Each subject corresponds to an appropriate section of this document where more detailed information on the subject can be found.

#### 1.4.1 Atlas V Launch System

The Atlas V 400 and 500 series launch vehicles are the latest evolutionary versions of the Atlas launch system and were placed into service in 2002. Atlas V uses a standard Atlas Booster, zero to five strap-on solid rocket boosters (SRBs), a Centaur in either the Single-Engine Centaur (SEC) or the Dual-Engine Centaur (DEC) configuration, and one of several Payload Fairings (PLF). Figure 1.4.1-1 illustrates key components of the Atlas V launch vehicles. A three-digit (XYZ) naming convention was developed for the Atlas V 400 and 500 series to identify its multiple configuration possibilities as illustrated in Figure 1.4.1-2.

The Atlas V 400 series employs the flight-proven 4-m diameter payload fairing in three discrete lengths: the Large Payload Fairing (LPF)—12.0 m (39.3 ft) in length; the Extended Payload Fairing (EPF) — 12.9 m (42.3 ft) in length; and the Extra Extended Payload Fairing (XEPPF) — 13.8 m (45.3 ft) in length. Figure 1.4.1-3 summarizes characteristics of the Atlas 400 series. Similarly, the Atlas V 500 series employs three lengths of the flight-proven 5.4-m diameter payload fairing: the 5.4-m short PLF, 20.7 m (68 ft) in length; the 5.4-m medium, 23.5 m (77 ft) in length; and the 5.4 m long, 26.5 m (87 ft) in length. Figure 1.4.1-4 summarizes characteristics of Atlas 500 series.

Figure 1.4.1-1: Atlas V Launch Vehicle Common System Elements



The Atlas V Heavy Lift Vehicle has been developed up to a Critical Design Review (CDR) level of completeness. The completion of the design is currently on hold pending firm mission requirements for this level of performance capability. At the time of this publication, the Atlas V HLV is approximately 30 months from authority to proceed (ATP) to launch, but would require a 36-month integration cycle instead of the typical 24-month integration shown for the Atlas V 400 and 500 series missions. The HLV information contained in various sections of this Atlas V Launch Services User's Guide are based on analyses at CDR and flight data for identical or similar hardware flown on the Atlas V 400 and 500 series vehicles. Figure 1.4.1-5 summarizes characteristics of the Atlas V HLV.

The Atlas V today meets a wide variety of commercial and U.S. government launch requirements. The Atlas V family, shown in Figure 1.4.1-6, includes the flight-proven performance to GTO for the Atlas V 400 and 500 series as well as the Atlas V Heavy Lift Vehicle, which is in development.

### 1.4.2 Atlas V Launch System Environments

The Atlas V launch system provides spacecraft preflight and flight environments that are typically more benign than those available with other launch systems. All environments specified for the Atlas V launch system (e.g., shock, vibration, acoustic, thermal, electromagnetic) are based on in-depth engineering analyses and flight testing of existing and evolved hardware. These have been fully validated with both test and flight telemetry data. Flight telemetry data from Atlas V vehicle configurations are continually used to update these environments as required. Atlas V verifies that the customer's flight environments remained within specified levels through a combination of standard instrumentation and analysis, or with use of additional mission-unique instrumentation near the spacecraft interface. This hardware enables high-

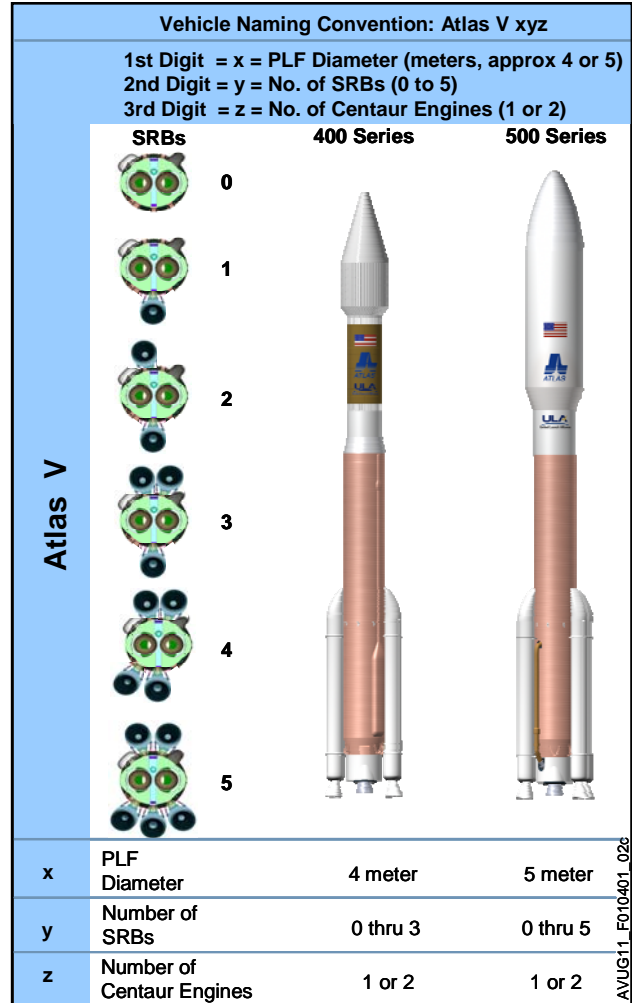
frequency telemetry measurements near the spacecraft interface. Section 3 discusses the environment envelopes to which customer spacecraft are exposed.

**1.4.3 Spacecraft and Ground System Interfaces**

The Atlas V launch system offers a broad range of launch vehicle and ground processing hardware and facility options to meet spacecraft interface requirements. Primary interfaces between the Atlas V launch vehicle and spacecraft consist of a payload adapter and a PLF. The payload adapter supports the spacecraft on top of the launch vehicle and provides mounting for the payload separation system, spacecraft electrical interfaces to the launch vehicle, mission-unique spacecraft purge system connections, and mission-unique instrumentation. The Atlas V program has a set of standard, flight-proven payload adapters to meet identified spacecraft interface requirements. Specialized payload adapters can be developed to meet mission-specific requirements of certain customer spacecraft. In addition, the user has the option to provide the payload adapter and separation system. Section 5 describes Atlas V payload adapter systems.

The PLF encloses and protects the spacecraft during ground operations and launch vehicle ascent. The PLF also incorporates hardware to control thermal, acoustic, electromagnetic, and cleanliness environments for the spacecraft and may be tailored to provide access and radio frequency communications to the encapsulated spacecraft. The Atlas V program offers three 4-m diameter payload fairing configurations: the LPF, the EPF, and the XEPF. A 5-m diameter PLF is available for Atlas V 500 vehicles in a short, medium, or long length configuration. Section 6 describes Atlas V PLF systems.

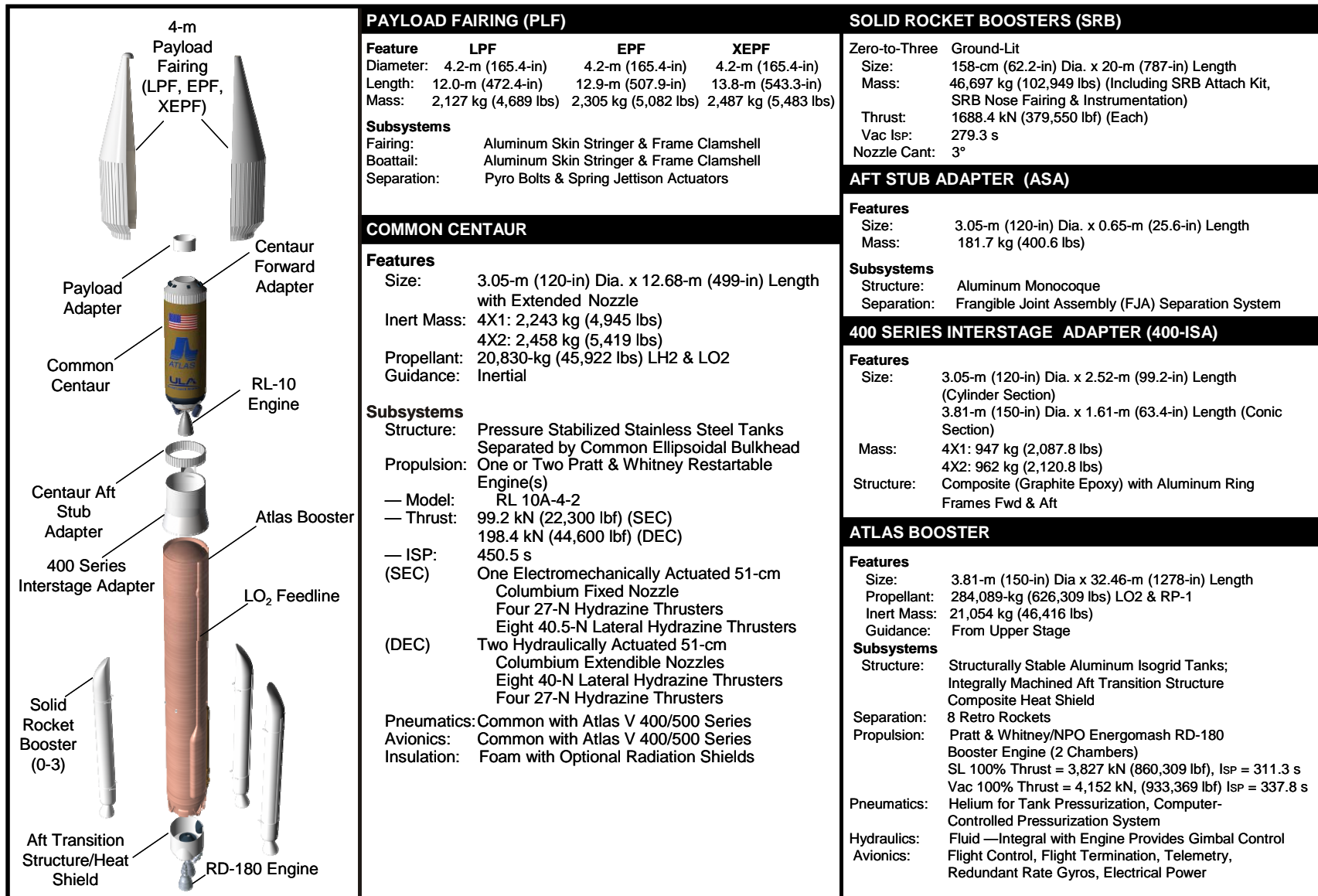
Figure 1.4.1-2: Atlas V Naming Convention



**1.4.4 Atlas V Mission Integration and Management**

The Atlas V mission integration and management process is designed to utilize the engineering and production talents of the ULA team. ULA also engages spacecraft contractor organizations to integrate the customer's spacecraft with the Atlas V launch vehicle. Section 4 discusses the mission integration process and launch services management functions currently in operation for commercial and government missions. For typical missions, a 24-month integration schedule is discussed. Section 4 also provides the management approach and summarizes integration analysis tasks to enable the customer to understand the process fully and participate where appropriate.

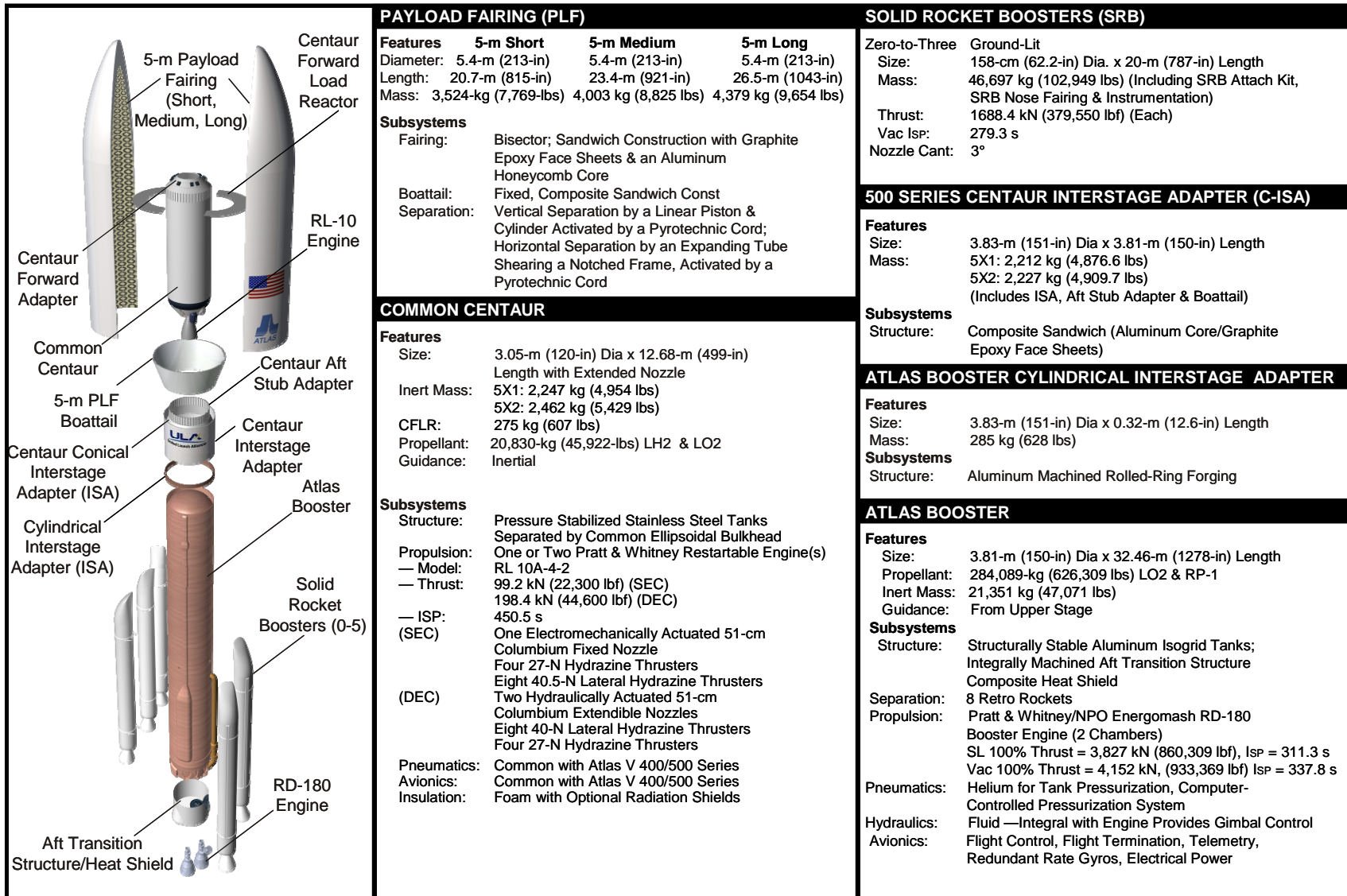
Figure 1.4.1-3: Atlas V 400 Series Launch System



PAYLOAD FAIRING (PLF)				SOLID ROCKET BOOSTERS (SRB)	
<b>Feature</b>	<b>LPF</b>	<b>EPF</b>	<b>XEPF</b>	<b>Zero-to-Three</b>	<b>Ground-Lit</b>
Diameter:	4.2-m (165.4-in)	4.2-m (165.4-in)	4.2-m (165.4-in)	Size:	158-cm (62.2-in) Dia. x 20-m (787-in) Length
Length:	12.0-m (472.4-in)	12.9-m (507.9-in)	13.8-m (543.3-in)	Mass:	46,697 kg (102,949 lbs) (Including SRB Attach Kit, SRB Nose Fairing & Instrumentation)
Mass:	2,127 kg (4,689 lbs)	2,305 kg (5,082 lbs)	2,487 kg (5,483 lbs)	Thrust:	1688.4 kN (379,550 lbf) (Each)
<b>Subsystems</b>				Vac ISP:	279.3 s
Fairing:	Aluminum Skin Stringer & Frame Clamshell			Nozzle Cant:	3°
Boattail:	Aluminum Skin Stringer & Frame Clamshell			<b>AFT STUB ADAPTER (ASA)</b>	
Separation:	Pyro Bolts & Spring Jettison Actuators			<b>Features</b>	
<b>COMMON CENTAUR</b>				Size:	3.05-m (120-in) Dia. x 0.65-m (25.6-in) Length
<b>Features</b>					
Size:	3.05-m (120-in) Dia. x 12.68-m (499-in) Length with Extended Nozzle				
Inert Mass:	4X1: 2,243 kg (4,945 lbs) 4X2: 2,458 kg (5,419 lbs)				
Propellant:	20,830-kg (45,922 lbs) LH <sub>2</sub> & LO <sub>2</sub>				
Guidance:	Inertial				
<b>Subsystems</b>					
Structure:	Pressure Stabilized Stainless Steel Tanks Separated by Common Ellipsoidal Bulkhead				
Propulsion:	One or Two Pratt & Whitney Restartable Engine(s)				
— Model:	RL 10A-4-2				
— Thrust:	99.2 kN (22,300 lbf) (SEC) 198.4 kN (44,600 lbf) (DEC)				
— ISP:	450.5 s				
(SEC)	One Electromechanically Actuated 51-cm Columbium Fixed Nozzle Four 27-N Hydrazine Thrusters Eight 40.5-N Lateral Hydrazine Thrusters				
(DEC)	Two Hydraulically Actuated 51-cm Columbium Extendible Nozzles Eight 40-N Lateral Hydrazine Thrusters Four 27-N Hydrazine Thrusters				
Pneumatics:	Common with Atlas V 400/500 Series				
Avionics:	Common with Atlas V 400/500 Series				
Insulation:	Foam with Optional Radiation Shields				
<b>400 SERIES INTERSTAGE ADAPTER (400-ISA)</b>				<b>ATLAS BOOSTER</b>	
<b>Features</b>					
Size:	3.05-m (120-in) Dia. x 2.52-m (99.2-in) Length (Cylinder Section) 3.81-m (150-in) Dia. x 1.61-m (63.4-in) Length (Conic Section)				
Mass:	4X1: 947 kg (2,087.8 lbs) 4X2: 962 kg (2,120.8 lbs)				
Structure:	Composite (Graphite Epoxy) with Aluminum Ring Frames Fwd & Aft				
<b>Features</b>					
Size:	3.81-m (150-in) Dia x 32.46-m (1278-in) Length				
Propellant:	284,089-kg (626,309 lbs) LO <sub>2</sub> & RP-1				
Inert Mass:	21,054 kg (46,416 lbs)				
Guidance:	From Upper Stage				
<b>Subsystems</b>					
Structure:	Structurally Stable Aluminum Isogrid Tanks; Integrally Machined Aft Transition Structure Composite Heat Shield				
Separation:	8 Retro Rockets				
Propulsion:	Pratt & Whitney/NPO Energomash RD-180 Booster Engine (2 Chambers) SL 100% Thrust = 3,827 kN (860,309 lbf), ISP = 311.3 s Vac 100% Thrust = 4,152 kN, (933,369 lbf) ISP = 337.8 s				
Pneumatics:	Helium for Tank Pressurization, Computer-Controlled Pressurization System				
Hydraulics:	Fluid —Integral with Engine Provides Gimbal Control				
Avionics:	Flight Control, Flight Termination, Telemetry, Redundant Rate Gyros, Electrical Power				

AVUG11\_F010401\_03h

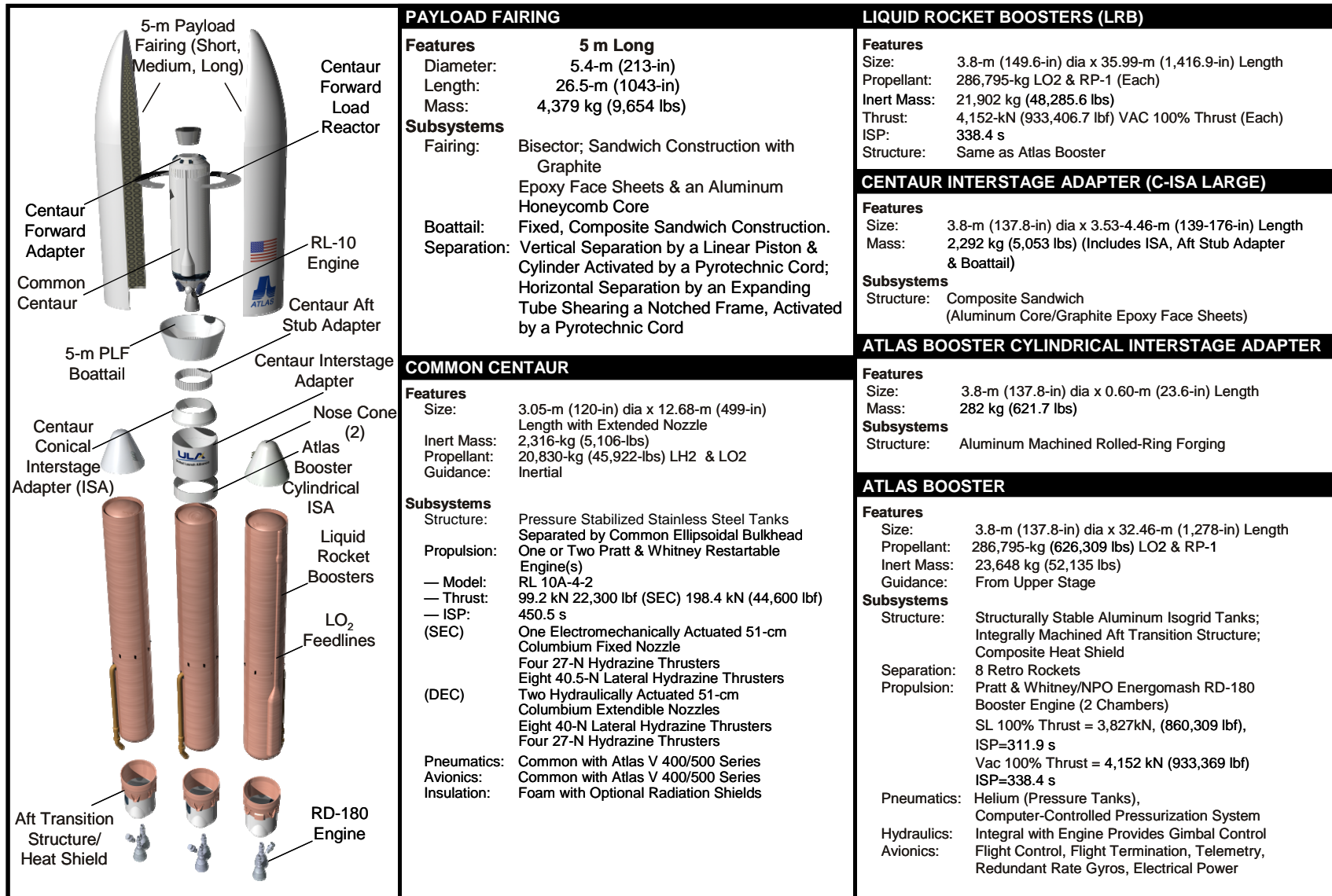
Figure 1.4.1-4: Atlas V 500 Series Launch System



AVUG11\_F010401\_04h






Figure 1.4.1-5: Atlas V HLV Launch System



AVUG11\_F010401\_05f

Figure 1.4.1-6: Atlas V Launch Vehicle Family

										
<b>Atlas V 400 Series</b>				<b>Atlas V 500 Series</b>					<b>HLV</b>	
<b>401</b>	<b>411</b>	<b>421</b>	<b>431</b>	<b>501</b>	<b>511</b>	<b>521</b>	<b>531</b>	<b>541</b>	<b>551</b>	–
<b>Performance to GTO (1,804 m/s), kg (lb)</b>										
4,750	5,950	6,890	7,700	3,775	5,250	6,475	7,475	8,290	8,900	13,000
(10,470)	(13,110)	(15,180)	(16,970)	(8,320)	(11,570)	(14,270)	(16,470)	(18,270)	(19,620)	(28,660)
<b>Performance to GTO (1,500 m/s), kg (lb)</b>										
3,460	4,450	5,210	5,860	2,690	3,900	4,880	5,690	6,280	6,860	
(7,620)	(9,810)	(11,480)	(12,910)	(5,930)	(8,590)	(10,750)	(12,540)	(13,840)	(15,120)	

AVUG11\_F010401\_06b

**1.4.5 Spacecraft and Launch Site Facilities**

Upon arrival at the East or West Coast launch sites, most spacecraft require the use of payload and/or hazardous processing facilities for fueling and final checkout of onboard systems before launch. Section 7 summarizes facilities available for final spacecraft processing. In addition, Section 7 defines operational capabilities and interfaces of the Atlas V launch complexes in operation at Cape Canaveral Air Force Station (CCAFS) in Florida and at Vandenberg Air Force Base (VAFB) in California.

**1.4.6 Atlas V Future Enhancements**

Section 8 provides insight to the Atlas V customer community of the Atlas V program plans for enhancing the Atlas V launch vehicle to meet launch services requirements of the 21<sup>st</sup> Century. Future enhancements include:

1. Large diameter & longer PLF
2. Common Upper Stage
3. Wide-Body Booster (WBB)
4. Heavy-Lift Evolution
5. Centaur Sun Shield (CSS)

For the latest information on future and current enhancements please contact ULA.

**1.4.7 Auxiliary and Dual Payload Accommodations**

The Atlas V program continuously strives to develop additional capabilities to directly support the needs of the spacecraft customer. Section 9 allows the Atlas V program to not only meet existing industry requirements, but to provide the flexibility to work with customers to incorporate new and emerging spacecraft technologies. This section describes current and new capabilities to support future auxiliary and dual payload missions.



### **1.4.8 Supplemental Information**

There are two appendices in this document to address various items in more detail:

1. Appendix A discusses the history, heritage, and evolution of the Atlas booster and Atlas/Centaur launch vehicles. A more detailed description of Atlas booster and Centaur stages and subsystems is provided. The reliability growth method for evaluating mission and vehicle reliability is also summarized.
2. Appendix B details our mission success philosophy and quality assurance process at ULA facilities and at those of major subcontractors and suppliers. It also describes our Perfect Product Delivery (PPD) ethic at the enterprise level to promote continuous improvement throughout ULA.

## **1.5 ADVANTAGES OF SELECTING UNITED LAUNCH ALLIANCE**

ULA maintains all agreements required to conduct ULA launch services for all customers. Agreements are in place covering spacecraft and launch vehicle processing facilities, launch pads, services, and launch site support at CCAFS and VAFB.

ULA provides the following key advantages to the customer:

1. Dedicated flight-proven, and reliable launch vehicles and ground system support facilities
2. Benign and fully validated launch environments for a customer's spacecraft (e.g., shock, vibration, acoustic, thermal)
3. Launch facilities at CCAFS (SLC-41) and VAFB (SLC-3E) to accommodate virtually any type of orbital requirements, including geostationary transfer orbits (GTO), low Earth orbits (LEO), low- or high-inclination orbits, sun-synchronous orbits, lunar transfer orbits, and interplanetary orbits
4. A streamlined launch processing approach and steady launch tempo to maintain schedules and commitments
5. More than a century of combined experience in providing assured access to space
  - a. Legacy reaching back to the 1950s
  - b. Pooled experience of more than 1,300 launches
6. A flexible and demonstrated mission design capability to maximize spacecraft on-orbit maneuver lifetime (OML) or other parameters through optimized pairing of spacecraft and the launch vehicle's customized performance capabilities

## **1.6 CONCLUSION**

ULA is eager to assist customers in defining and developing future Atlas V missions. Atlas V customers may refer to the Preface of this guide for information regarding the appropriate representative to contact for their mission requirements.

Intentionally Left Blank

## 2. TRAJECTORY AND PERFORMANCE

Over the past five decades, Atlas boosters and Centaur upper stages have flown together as the Atlas/Centaur launch vehicle (LV) and with other stages (e.g., Atlas/Agena and Titan/Centaur) to deliver commercial, military, and scientific spacecraft (SC) to their target orbits. Based on experience with more than 600 Atlas launches, performance for each LV is determined by engineering analysis of existing and new hardware, emphasizing conservative performance predictions to ensure each vehicle meets design expectations. Because the Atlas V 400 and 500 series configurations are flight-proven, the performance capabilities reflect flight-qualified hardware performance characteristics. This section further describes the Atlas V family mission and performance options available with East and West Coast launches.

Atlas V LVs can meet performance requirements by customizing (or standardizing) mission and trajectory designs to meet specific SC mission requirements. ULA offers performance capability levels (as opposed to explicit hardware configurations) as part of a standard launch service package to meet evolving commercial, civil government, and military SC mission launch requirements. The Atlas V 400 and 500 series LVs can be launched from either Cape Canaveral Air Force Station (CCAFS) in Florida or Vandenberg Air Force Base (VAFB) in California.

Vehicle performance can be utilized in several ways. For SC whose primary mission may require less performance than a specific Atlas V 400 or 500 series configuration, additional mission constraints can be specified that will use excess performance to benefit the launch services customer. For example, ascent trajectory designs can be shaped to improve ground coverage of major events or reduce the energy required by the SC to reach its final orbit. The ascent profile can be standardized to reduce mission integration analyses and/or schedules.

Performance capabilities quoted throughout this document are presented in terms of Payload Systems Weight (PSW). PSW is defined as the combined equivalent mass to orbit of the separated SC, the SC-to-LV adapter, and other mission-unique hardware required on the LV to support the SC (e.g., SC flight termination system, harnessing). Also, mission-unique ground rules which impact performance, such as park orbit perigee altitude or Payload Fairing (PLF) jettison criteria, will be considered to have an effective PSW equivalent to the performance effect of that ground rule. See Section 2.5.1 for more details on Payload Systems Weight.

### 2.1 MISSION DESCRIPTIONS

Atlas V is a reliable and versatile launch system capable of delivering SC to a wide range of elliptical orbits, low circular orbits, high circular orbits, and Earth-escape trajectories. All Atlas V LVs are capable of launching a single large SC or multiple SC populating low and medium earth orbit constellations, or a mix of primary and secondary SC. The Centaur is qualified for multiple engine starts to facilitate placement of rideshare SC into different orbits or attaining low inclination, high-altitude orbits such as Geosynchronous Orbit (GSO) or near-GSO. The trajectory design for each mission can be specifically tailored to optimize the mission's critical performance parameter (e.g., maximum SC orbit lifetime, maximum weight to orbit) while satisfying SC and LV constraints.

Atlas V mission ascent profiles are developed using one or more Centaur main engine burns. Each mission profile type is suited for a particular type of mission. The following paragraphs describe three ascent techniques with mission applications.

### 2.1.1 Direct Ascent Mission (1 Centaur Burn)

For this mission design, the Centaur main engine(s) are ignited just after Atlas/Centaur separation. The main engine burn continues until the Centaur and SC are placed into the targeted orbit. Centaur/SC separation occurs shortly after the Centaur burn is completed. Direct ascents are primarily used for Low-Earth circular orbits (LEO), Earth Escape, and for elliptic orbits with orbit geometries (i.e., arguments of perigee and inclinations) easily reached from the launch site. For most LEO missions, performance with two Centaur engines is higher than with a single engine. Orbits achievable with little or no LV yaw steering and those that can be optimally reached without coast phases between burns are prime candidates for the direct ascent mission design.

### 2.1.2 Parking Orbit Ascent Mission (2 Centaur Burns)

The parking orbit ascent, used primarily for high LEO, MEO, and Geosynchronous Transfer Orbit (GTO) missions, is the most widely used Atlas V trajectory design. Performance capabilities are based on two Centaur main engine burns injecting the Centaur and the SC into an orbit not achievable by direct ascent. The first Centaur main engine burn starts just after Centaur separation from the booster and is used to inject the Centaur/SC into a mission optimal parking orbit. After a coast to the optimal location, the second Centaur main engine burn places the SC into the desired orbit. If targeted to a transfer orbit, the SC must then use its own propulsion system to achieve the final mission orbit. For non-transfer orbit missions where the Centaur delivers the SC to the final mission orbit, the second Centaur main engine burn is used to inject the SC into the desired orbital conditions. The parking orbit ascent profile is used for GTO, high-altitude circular and elliptical orbits, and Earth escape trajectories requiring a coast phase to meet target conditions.

### 2.1.3 Park to Transfer Ascent Mission (3 Centaur Burns)

The GSO mission is a typical three-burn Centaur mission profile. The three-burn mission design is usually characterized by both very high altitude and substantially reduced inclination at SC separation. A detailed profile is outlined in Section 2.4.2. Another typical three-burn scenario is a direct ascent to a low-Earth orbit followed by transfer and insertion into a higher circular orbit. This usually involves two (or more) SC on the LV.

## 2.2 LV ASCENT DESCRIPTIONS

### 2.2.1 Booster Phase

The Atlas booster phase begins with the ignition of the RD-180 engine system followed by Solid Rocket Booster (SRB) ignition, if applicable, and ends with booster engine throttle down and booster shutdown.

#### 2.2.1.1 Atlas V 400 Series

The Atlas V 400 series consists of an Atlas booster combined with zero to three SRBs, a Centaur, and a 4-m diameter PLF. The booster phase begins with ignition of the RD-180 engine system. The LV is held down during booster engine start and a portion of booster start-up. A vehicle health check is performed before achieving full throttle. After passing the health check, the vehicle is released, SRB ignitions occur (if applicable), and booster start-up is completed. After a short vertical rise away from the pad, the 400 series LV begins pitch-over, a coordinated maneuver to the prescribed ascent profile and direction. At a predetermined altitude, the Atlas V LV transitions to a nominal zero-alpha and zero-beta angle-of-attack orientation to minimize aerodynamic loads and engine angles. Both of these maneuvers are implemented through the launch-day wind-steering system, Automatic Determination and Dissemination of Just Upgraded Steering Terms (ADDJUST) which enhances launch availability by reducing wind-induced flight loads and engine deflections.

For Atlas V 401 or 402 configurations, after reaching 24,380 m (80,000 ft) until 33,530 m (110,000 ft), an alpha-bias angle-of-attack steering technique is used to improve performance while maintaining aerodynamic loading within acceptable limits.

Closed-loop guidance steering is enabled at the end of alpha-biased steering. For all Atlas V 400 series LVs with SRBs, the zero-alpha/zero-beta attitude is maintained until 6 seconds after the initial SRB jettison when closed-loop guidance steering is enabled. The SRB jettison sequence is initiated after SRB burnout. SRBs 1 and 2, if applicable, are jettisoned at a predetermined time dependent upon a dynamic pressure constraint. SRB 3 is jettisoned 1.5 seconds later, if applicable.

Near the end of the booster phase, the RD-180 engine is continuously throttled so that axial acceleration levels are not exceeded. These g-levels may be a function of payload weight and do not exceed 5.0 g steady state.

The RD-180 cutoff sequence is initiated when a propellant low-level sensor system indicates that the Atlas booster is about to deplete available propellants. At this time, the booster engine is shut down. All Atlas V 400 series configurations retain the PLF through the booster phase of flight.

### **2.2.1.2 Atlas V 500 Series**

The Atlas V 500 series consists of an Atlas booster combined with zero to five SRBs, a Centaur, and a 5-m diameter PLF. The RD-180 and SRB ignition sequence is the same as the Atlas V 400 series vehicles. After a short vertical rise away from the pad, the 500 series vehicle begins pitch-over a coordinated maneuver to the prescribed ascent profile and direction. At a predetermined altitude, the Atlas/Centaur LV transitions to a nominal zero-alpha and zero-beta angle-of-attack orientation to minimize aerodynamic loads and engine angles. Both of these maneuvers are implemented through the launch-day wind-steering system, which enhances launch availability by reducing wind-induced flight loads and engine deflections.

For Atlas V 501 or 502 configurations, after reaching 24,380 m (80,000 ft) until approximately 33,530 m (110,000 ft), an alpha-bias angle-of-attack steering technique is used to improve performance while maintaining aerodynamic loading within acceptable limits. The booster phase steering profile through the end of alpha-biased steering is implemented through our launch-day wind-steering system

Closed-loop guidance steering is enabled at the end of alpha-biased steering. For all Atlas V 500 series vehicles with SRBs, the zero-alpha/zero-beta attitude is maintained until 6 seconds after the initial SRB jettison when closed-loop guidance steering is enabled. The SRB jettison sequence is initiated after SRB burnout. SRBs 1 and 2, if applicable, are jettisoned at a predetermined time dependent upon the dynamic pressure constraint. SRBs 3, 4, and 5 are jettisoned 1.5 seconds later, if applicable.

For Atlas V 500 series missions, the PLF is jettisoned during the booster phase of flight. Before PLF jettison, the RD-180 engine is throttled down to maintain 2.5 g acceleration. Typically, the PLF is jettisoned when the 3-sigma free molecular heat flux falls below  $1,135 \text{ W/m}^2$  (360 Btu/ft<sup>2</sup>-hr). For sensitive SC, PLF jettison can be delayed to reduce the heat flux with minor performance loss. After PLF jettison, the RD-180 is throttled up.

Near the end of the booster phase, the RD-180 engine is continuously throttled so that specific axial acceleration levels are not exceeded. These g-levels may be a function of payload weight and typically do not exceed 4.6 g steady state.

The RD-180 cutoff sequence is initiated when a propellant low-level sensor system indicates that the Atlas booster is about to deplete available propellants. At this time, the booster engine is shut down.

### 2.2.1.3 Atlas V Heavy Lift Vehicle

The Atlas V HLV maximizes commonality between Atlas V LVs by using a single Atlas booster for the core flanked by two additional Atlas boosters serving as strap-on Liquid Rocket Boosters (LRBs). A single RD-180 engine powers each Atlas booster, the same engine that is used on the Atlas V 400 and 500 series LVs, and commonality continues with the use of the Centaur. The HLV uses the same interstage adapters, avionics suite, and 5-m payload fairings that are common with the 500 series.

All three RD-180 engines start simultaneously and reach full thrust shortly after liftoff. After a short vertical rise away from the pad, the HLV begins a coordinated maneuver to the prescribed ascent profile and direction. The HLV transitions to a nominal zero-alpha and zero-beta angle-of-attack phase to minimize aerodynamic loads and engine angles. Both of these phases are implemented through the launch-day wind-steering system, which enhances launch availability by reducing wind-induced flight loads and engine deflections. Shortly into this phase, the core Atlas booster's RD-180 is throttled back to optimize performance.

After reaching 24,380 m (80,000 ft), closed-loop guidance steering is enabled. The LRB cutoff sequence is initiated when a propellant low-level sensing system indicates that the first of the two LRBs is about to deplete available propellants. At this time, both LRB RD-180 engines are shut down, and the LRBs are jettisoned.

The vehicle is now in the core solo phase. The PLF is jettisoned typically when the 3-sigma free molecular heat flux falls below  $1,135 \text{ W/m}^2$  ( $360 \text{ Btu/ft}^2\text{-hr}$ ) during this phase. For sensitive SC, PLF jettison can be delayed to reduce the heat flux with minor performance loss. After PLF jettison, the core RD-180 is throttled up.

Near the end of the core solo phase, the RD-180 engine is continuously throttled so that specific axial acceleration levels are not exceeded. These g-levels may be a function of payload weight and do not exceed 5.0 g steady state.

The core RD-180 cutoff sequence is initiated when a propellant low-level sensor system indicates that the Atlas booster is about to deplete available propellants. At this time, the engine is shut down.

### 2.2.2 Centaur Phase

The Atlas V Centaur can be configured as either a Single Engine Centaur (SEC) or a Dual Engine Centaur (DEC). The Centaur first burn Main Engine Start (MES1) occurs approximately 10 seconds after the Atlas booster is jettisoned. For typical Atlas V 400 series missions, the PLF is jettisoned 8 seconds after MES1, by which time the 3-sigma free molecular heat flux has typically fallen below  $1,135 \text{ W/m}^2$  ( $360 \text{ Btu/ft}^2\text{-hr}$ ). For sensitive SC, PLF jettison can be delayed later into the flight with minor performance loss.

For direct ascent missions, a single, long duration main engine burn injects the Centaur/SC into the targeted orbit after which Centaur performs a series of pre-separation maneuvers. For parking orbit ascent missions, the Centaur first main engine burn (typically the longer of the two) injects the SC into a mission-optimized parking orbit. After first burn Main Engine Cutoff (MECO1), the Centaur and SC enter a coast period, about 10 minutes for a SEC geosynchronous transfer mission, during which the Centaur aligns itself to the attitude required for the Centaur second burn Main Engine Start (MES2). Should a SC require attitude maneuvers during longer coast periods, the Centaur can accommodate roll axis alignment requirements and provide commanded roll rates from 0.5 to 1.5 deg/sec in either direction during significant portions of the coast period. Accommodation of larger roll rates can be evaluated on a mission-unique basis. For long-coast missions, the Centaur vehicle is aligned to the ignition attitude prior to the Centaur MES2. At a guidance-calculated time, the Centaur main engine is re-ignited, and the vehicle is guided to the desired orbit.

After reaching the target orbit, the Centaur main engine is shut down (MECO2), and Centaur begins its alignment to the SC separation attitude. Centaur can align to any required attitude for SC separation. Pre-

separation spin-ups of up to  $5.0 \pm 0.5$  rpm about the roll axis can be accommodated. In addition, a pitch/yaw plane transverse spin mode can be used.

The Atlas V 500 series vehicles (with two or more SRBs) and the HLV have the capability to perform full or partial geosynchronous missions, requiring three Centaur burns. For these missions, the Centaur is equipped with a Geosynchronous Orbit Kit (GSO Kit), which includes additional battery power, a full compliment of hydrazine maneuvering propellant, and additional shielding over sensitive components including the hydrogen and oxygen tanks. After Centaur MECO2, the vehicle enters an approximate 5-hour coast period to geosynchronous altitude during which the Centaur performs numerous thermal conditioning maneuvers. At a guidance-calculated time, the Centaur aligns to the third burn attitude, the main engine is re-ignited (MES3), and the vehicle is guided to the desired orbit.

For all missions, after Centaur/SC separation, Centaur conducts a Collision and Contamination Avoidance Maneuver (CCAM) to prevent recontact and minimize contamination of the SC. A blowdown of remaining Centaur propellants follows after completion of the CCAM.

## **2.3 MISSION DESIGN**

### **2.3.1 Geo-transfer Trajectory and Performance Options**

United Launch Alliance has identified the standard GTO as 185 km perigee by 35,786 km apogee (100 nmi perigee by 19,323 nmi apogee) inclined 27 degrees. This is accomplished with the park orbit ascent profile. After a short-coast, the transfer burn occurs across the first descending node, resulting in an argument of perigee of 180 degrees. The remaining  $\Delta V$  to geosynchronous equatorial orbit is 1804 m/sec (5918.6 ft/sec). The performance capabilities of the Atlas V vehicle configurations to this orbit are listed in Table 2.6-1. For SC weights heavier as well as lighter than the standard GTO capability and through Centaur's flexible flight software, a number of trajectory designs are possible, each of which will minimize the SC's remaining  $\Delta V$  to GSO. The following trajectory designs are available to maximize on-orbit lifetime of SC that use a common source of liquid propellant for orbit insertion and on-orbit station keeping. The optimal solution depends on mission requirements, total SC mass, and dry mass-to-propellant mass ratio.

1. Subsynchronous transfer and perigee velocity augmentation
2. Short-coast geosynchronous transfer (and reduced inclination transfers)
3. Supersynchronous transfer
4. Long-coast and extended coast geosynchronous transfer
5. Three-burn GSO Injection

Since most SC "qualify" for more than one of the above options, Table 2.3.1-1 at the end of this section shows example SC delta V to GSO comparisons of multiple options.

#### **2.3.1.1 Subsynchronous Transfer and Perigee Velocity Augmentation**

For SC heavier than the standard GTO capability for a particular Atlas V configuration, the Perigee Velocity Augmentation (PVA) trajectory design can provide increased propellant mass at beginning-of-life on GSO compared with the standard GTO design. Rather than off-load propellant to lower the launch mass to the standard GTO capability, the SC is fully loaded and injected into a subsynchronous transfer orbit. This is beneficial when propellant tank capacity is large with respect to the dry mass because usable propellant on board the SC is almost always more effective than higher apogee altitude. The Atlas V LV delivers the SC to a subsynchronous intermediate transfer orbit (apogee less than geosynchronous) with an inclination of approximately 27 degrees since the SC mass exceeds GTO launch capability. The separated SC coasts to subsequent transfer orbit perigee(s), where the SC supplies the required  $\Delta V$  for insertion into

geosynchronous transfer. At apogee, using one or more burns, the SC lowers inclination and circularizes into GSO. As illustrated in Table 2.3.1-1, mass at beginning-of-life is enhanced. The orbit profile is shown in Figure 2.3.1.1-1. Several Atlas LV missions have successfully used the subsynchronous transfer option.

### 2.3.1.2 Short-coast Geosynchronous Transfer Orbit

The short-coast mission is the standard mission design for GTO launches. Figure 2.3.1.2-1 illustrates the orbital mission profile involved. For SC that need to maintain geosynchronous altitude, 35,786 km (19,323 nmi), at the end of the transfer burn, the inclination will decrease from 27 degrees as the SC mass decreases. The transfer orbit inclination depends on LV capability, SC launch mass, and performance characteristics of both systems. With SC weighing less than the GTO capability of the LV, excess performance can be used to further reduce inclination, raise perigee or both. At inclinations less than 20 degrees the LV can start increasing perigee and still maintain a relatively short-coast and thus mission duration.

### 2.3.1.3 Supersynchronous Transfer

Many SC do not need to maintain geosynchronous altitude after the transfer burn and are capable of increasing above the standard GSO altitude of 35,786 km. The supersynchronous trajectory design offers an increase in beginning-of-life propellants by decreasing the delta-velocity ( $\Delta V$ ) required of the SC for orbit insertion. This option is available if the LV capability to standard GTO is greater than the Payload Systems Weight. Initially, excess capability is used to increase apogee altitude. If the apogee altitude capability exceeds the SC maximum allowable altitude, excess LV performance is used to lower orbit inclination. Optimally, when inclination reaches about 20 degrees, the perigee altitude starts to increase. The  $\Delta V$  required of the SC to reach GSO continues to decline. At supersynchronous altitudes, the decreased inertial velocity at apogee allows the SC to make orbit plane changes more efficiently. The SC makes the plane change and raises perigee to geosynchronous altitude in one or more apogee burns. The SC then burns at perigee to continue to decrease the orbit inclination to 0 degrees and to lower the apogee so as to circularize into final geostationary orbit. The total  $\Delta V$  to GSO in this supersynchronous transfer design is less than would be required to inject from an equivalent performance reduced inclination geosynchronous transfer, resulting in more SC propellants available for on-orbit operations. Figure 2.3.1.3-1 illustrates the supersynchronous trajectory mission profile. Supersynchronous transfer trajectories have been flown on Atlas LV missions since December 1991.

### 2.3.1.4 Long-Coast and Extended-Coast Geosynchronous Transfer

The first Atlas V long-coast geotransfer mission was performed by AV-003 in July 2003, in which the transfer burn was delayed to occur across the first ascending node, creating an apogee of 35,786 km and an argument of perigee of 0 degrees. This technique extends the park orbit coast by approximately 1 hour but can substantially reduce the SC's  $\Delta V$  to GSO by achieving a relatively high perigee as well as a reduced inclination.

Another long-coast technique substantially reduces the  $\Delta V$  to GSO, but the transfer burn does not occur across a node. Instead, the Centaur extends the first burn duration to achieve an elliptical park orbit. After a coast of up to 2 hours, the Centaur re-ignites its engine to extensively raise perigee and achieve an argument of perigee of 180 degrees. The extended coast allows Centaur to perform the second burn at a very high altitude thus raising perigee very efficiently. Figure 2.3.1.4-1 shows the extended coast trajectory design with example orbit parameters.



Figure 2.3.1.1-1: Subsynchronous Transfer Orbit Mission Trajectory Profile

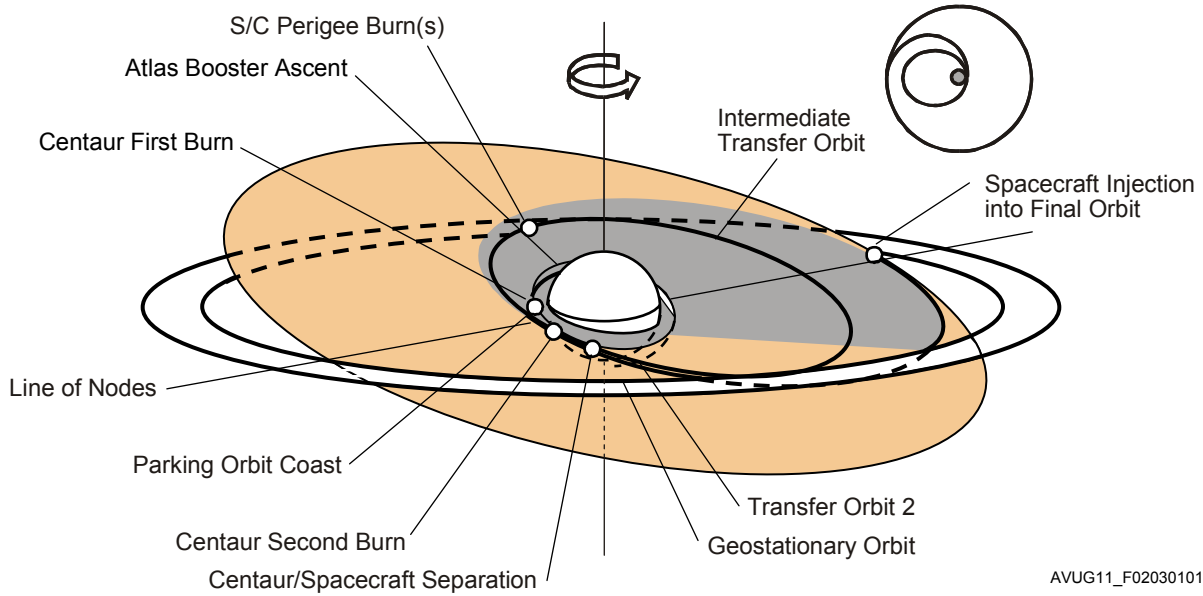


Figure 2.3.1.2-1: Short-coast Geosynchronous Transfer Orbit Mission Trajectory Profile

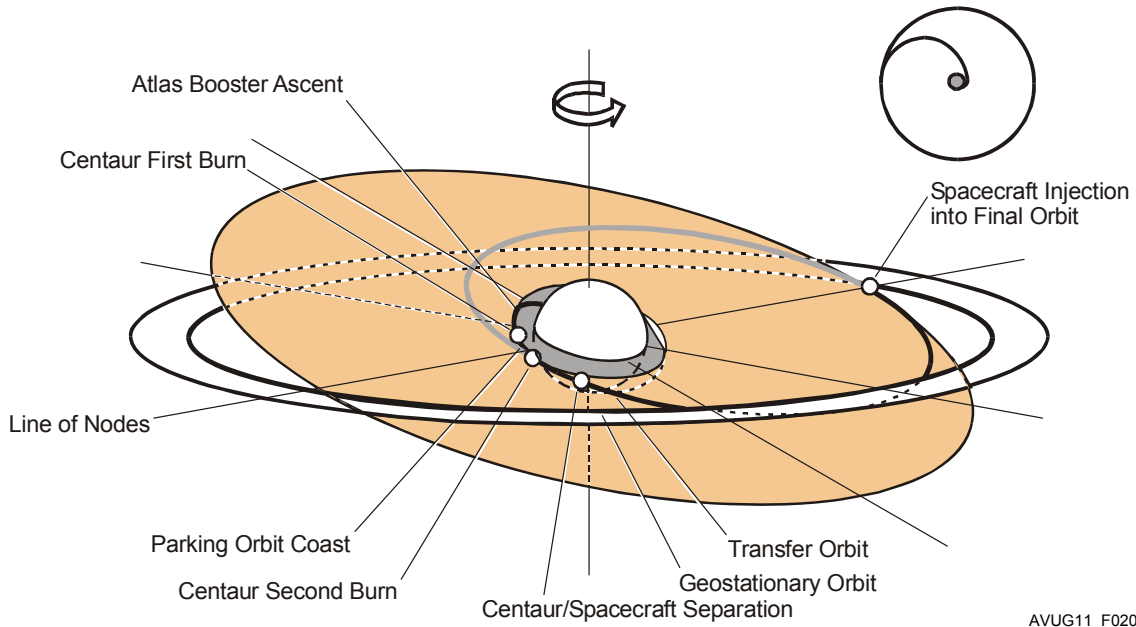


Figure 2.3.1.3-1: Supersynchronous Transfer Orbit Mission Trajectory Profile

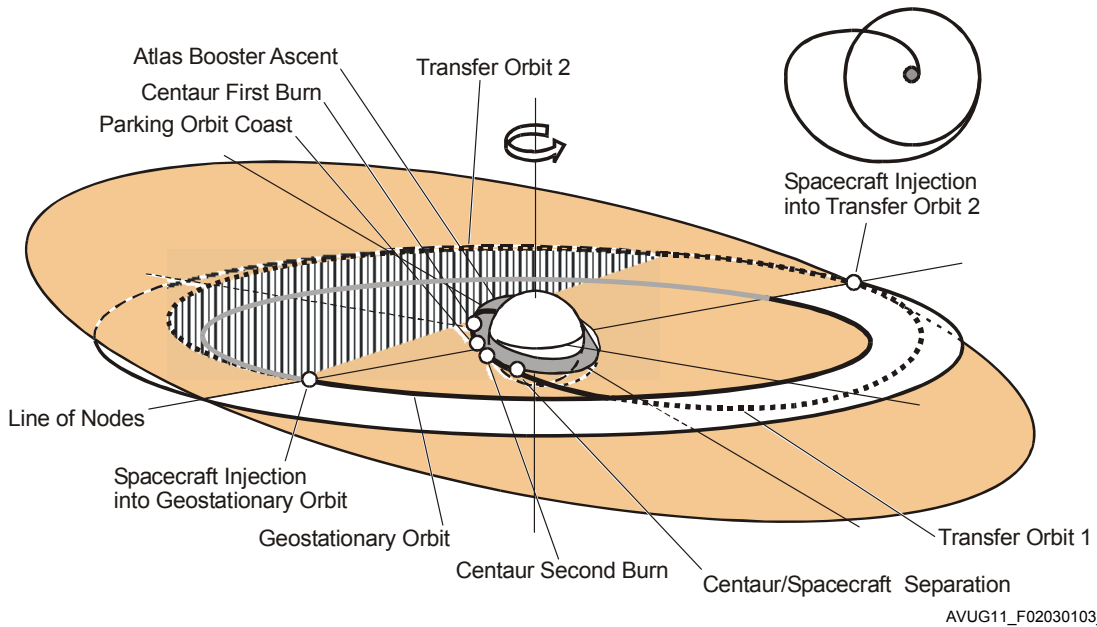
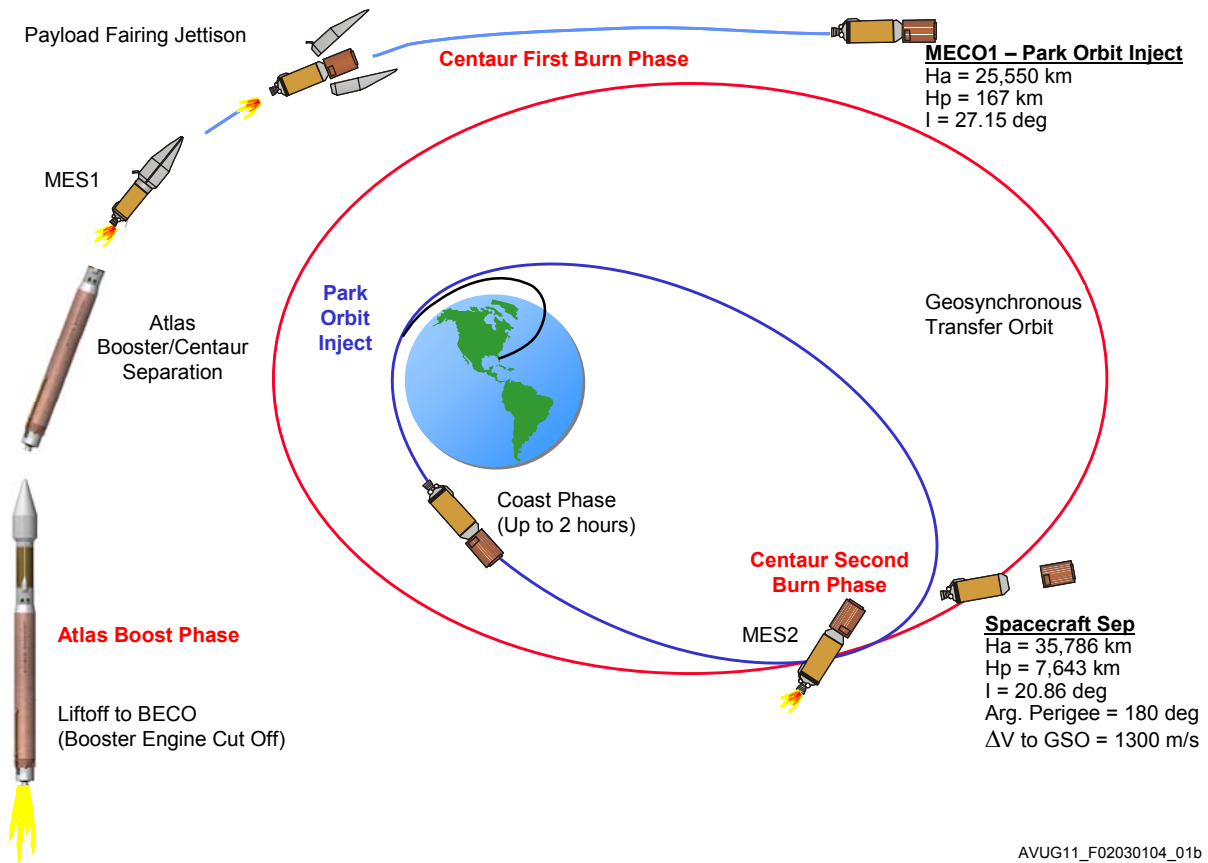


Figure 2.3.1.4-1: Extended Coast Transfer Orbit Mission Trajectory Profile



**Table 2.3.1-1: Geotransfer Option Benefits (Example Comparison)**

Parameter	Sub-Synchronous		Super-Synchronous		Extended Coast	
	GTO	Subsynch	GTO	Super-synch	Super-synch	Extn. Coast
Atlas V LV	401		521			
S/C Mass, kg (lb)	4,750* (10,472)	4,948 (10,909)	5,860 (12,918)	5,860 (12,918)	4,576 (10,088)	4,576 (10,088)
Transfer Orbit Parameters						
• Perigee Altitude, km (nmi)	185 (100)	185 (100)	185 (100)	185 (100)	759 (410)	6,153 (3,322)
• Apogee Altitude, km (nmi)	35,786 (19,323)	30,000 (16,199)	35,786 (19,323)	60,000 (32,397)	60,000 (32,397)	35,786 (19,323)
• Orbit Inclination, degree	27.0	27.0	20.5	27.0	18.1	22.5
• Argument of Perigee, degree	180	180	180	180	180	180
Centaur Burns — Number	2	2	2	2	2	2
SC $\Delta V$ , m/s (ft/sec) (Required for GSO Insertion)	1,804 (5,918.6)	1,912 (6,273.0)	1,676 (5,498.1)	1,638 (5,374.0)	1,502 (4,928)	1,400 (4,593.2)
<b>Note:</b> * SC offloaded to achieve GTO altitude.						

**2.3.1.5 Three-Burn Geo-transfer/Geosynchronous Orbit Injection**

This is the most efficient geo-transfer trajectory design option and is available to SC with very low  $\Delta V$  -to-GSO requirements. This option is currently available on the Atlas V 521, 531, 541, 551 LVs and HLV. This type of profile combines the parking orbit ascent to a geosynchronous transfer burn with a long-coast followed by a third Centaur burn. The first Centaur burn starts just after Atlas/Centaur separation and is used to inject the Centaur/SC into a mission performance optimal parking orbit. After a coast to the desired location for transfer orbit injection, the second Centaur burn places the SC into transfer to geosynchronous altitude. A 5.2 hour coast follows the second burn. The Centaur engine is ignited for a third time near the apogee of the transfer orbit. This final third burn circularizes the Centaur/SC at synchronous altitude and reduces the inclination to 0 degrees. For heavier SC, where true geosynchronous equatorial orbit cannot be fully achieved, the third burn substantially reduces the remaining  $\Delta V$  to GSO over all 2-burn GTO flight design options.

**2.3.2 Mission Optimization and Geo-transfer Performance Enhancement Options**

Atlas V LV trajectory designs are developed using an integrated trajectory simulation executive and a state-of-the-art optimization algorithms. ULA utilizes our vast knowledge of LV trajectories optimization techniques to maximize LV performance capabilities while considering specific LV constraints.

United Launch Alliance's experience launching interplanetary and scientific SC has enabled us to add an additional trajectory analysis tool to assist in the mission design/mission optimization process. The N-BODY trajectory simulation program is used, with our optimization capability, to develop LV missions requiring precision inertial targeting in which perturbation effects of other celestial bodies are required to be considered.

Atlas V uses these trajectory analysis tools and our extensive guidance and targeting capabilities to include SC characteristics and programmatic goals in our mission optimization. It is sometimes possible to improve the nominal or high performing cases of a mission design by taking advantage of one of our mission enhancement options for those SC that can tolerate a variable injection state. The most widely used options are:

1. Inflight Retargeting (IFR)
2. Minimum Residual Shutdown (MRS)
3. IFR/MRS combination

4. Explicit Right Ascension of Ascending Node (RAAN) control

It should be noted that these mission enhancement options affect both the nominal injection state as well as the 99% confidence injection state. Please contact United Launch Alliance for details on how each option would affect your particular mission requirements.

**2.3.2.1 Inflight Retargeting**

The software capability of the Centaur makes it possible to evaluate the Atlas V booster performance during ascent and to target for an optimal injection condition that is a function of the performance of the booster. Centaur can retarget transfer orbit inclinations for the standard short-coast mission and the long-coast (ascending node transfer) mission. IFR can provide a dual performance benefit. First, the nominal LV Flight Performance Reserve (FPR) is reduced when the FPR contribution due to Atlas V booster dispersion is eliminated (and reflected in varying inclination). Second, whether Atlas V booster performance is high, nominal, or low, the retargeting logic is calibrated to devote appropriate equivalent performance to benefit the mission. While the 99% confidence injection orbit is roughly equivalent to a standard GCS, IFR does improve the nominal and positive performing cases (and even low performing cases above 99% low) by injecting the Centaur into a lower inclination orbit. With IFR, any desired level of confidence of a guidance shutdown can be implemented. IFR has been successfully flown on several missions, starting with the Atlas II/EUTELSAT II mission on December 7, 1991.

**2.3.2.2 Minimum Residual Shutdown**

Centaur propellants may be burned to minimum residual levels for a significant increase in nominal performance capability. When burning to minimum residuals, FPR propellants are eliminated to nominally gain additional  $\Delta V$  from Centaur. While the 99% confidence injection orbit is roughly equivalent to (though typically slightly lower than) a standard GCS, MRS does improve the nominal and positive performing cases (and even low performing cases above 99% low) by injecting the Centaur into a higher apogee orbit with the supersynchronous mission design; or into a higher perigee with the extended coast design (apogee can be slightly higher than 35,786 km). With MRS, any desired level of confidence of a guidance shutdown can be implemented. For MRS missions designed to take full advantage of all usable propellants, a guidance-commanded shutdown would only occur for a 6-sigma high performing vehicle. Alternatively, the MRS targets may be set to result in a guidance shutdown for a nominal vehicle (i.e., 50% chance to GCS, 50% chance to MRS) or any other probability of GCS. This implementation is typically used to protect a maximum apogee cap requirement.

**Table 2.3.2.2-1: Atlas V Perigee Velocity Variations with MRS**

Perigee Velocity Dispersions	2.33 Sigma	3 Sigma
Atlas V 400 Series	75.9 m/s (249 ft/sec)	97.7 m/s (321 ft/sec)
Atlas V 500 Series	59.1 m/s (194 ft/sec)	76.1 m/s (250 ft/sec)

It is practical for Centaur to burn all its propellants when the SC has a liquid propulsion system that is capable of correcting for variations in LV performance. This option is particularly attractive and appropriate when the trajectory design includes a supersynchronous or subsynchronous PVA transfer orbit. MRS is typically not an option for SC using solid propellant (fixed impulse) Orbit Insertion Stages (OISs) because FPR propellants are required to ensure that the Centaur injection conditions will match the capability of the fixed impulse stage.

When Centaur burns all propellants to minimum residuals, the liquid propellant SC compensates for the effects of the actual LV performance. This primarily affects apogee altitude. The Atlas V performance variations associated with MRS are shown in Table 2.3.2.2-1. Variations in other transfer orbit parameters are minor (though significantly larger than typical GCS injection accuracies). The performance variation associated with MRS can also be quantified as an error in injection velocity that can be approximated as a dispersion in transfer orbit perigee velocity for most mission design types. MRS has been successfully executed for numerous missions.

### 2.3.2.3 IFR/MRS Combination

This mission design allows the transfer orbit inclination target to vary with Atlas V booster performance while apogee altitude varies with Centaur performance. As with MRS alone, no Centaur propellants remain to guarantee a specific transfer orbit target apogee so this design takes full advantage of flight performance. IFR/MRS is typically used with an apogee cap. Using a part of the performance for inclination reduction reduces the range of apogee altitudes at injection. This option is beneficial to SC that are nominally near their maximum allowable injection apogee by allowing some positive performance to be used to decrease inclination while still using the remaining positive performance to raise injection apogee.

### 2.3.2.4 Right Ascension of Ascending Node Control

Some SC mission objectives may require launch-on-time placement into transfer and/or final orbit. For Earth orbital missions, RAAN may be targeted to a specific value or range of values. Centaur's heritage of meeting the inertial orbit placement requirements associated with planetary missions makes it uniquely capable of targeting to an orbit RAAN (or range of RAANs dictated by actual launch time in a launch window) in addition to the typical target parameters. With GTO missions, some SC mission operational lifetimes can be enhanced by controlling RAAN of the targeted transfer orbit. A SC intended to operate in a non-0 degree geosynchronous final orbit can benefit with proper RAAN placement. A drift toward a 0 degree inclination orbit can help reduce the typical north-south station keeping budget of the SC thereby increasing the amount of time the SC can remain in an operational orbit.

## 2.3.3 Injection Accuracy and Separation Control

The combination of the Atlas V precision guidance hardware with flexible guidance software provides accurate SC injection conditions for a wide variety of mission types. These functional capabilities have been demonstrated on LEO and GTO missions.

Injection accuracies for a variety of GTO and LEO missions are displayed in Table 2.3.3-1 and are typical of 3-sigma accuracies following final Centaur burn. To date, the Atlas LV has met all GTO mission injection accuracy requirements.

On more than 100 past missions, United Launch Alliance has demonstrated its capability to deliver SC of various volumes and masses to precisely targeted orbits. Because the Atlas V vehicle is primarily designed for dedicated, single payload missions, a number of Atlas-unique, flight-proven mission trajectory and targeting enhancement options are offered to maximize the benefits of the Atlas V system to the SC mission. Atlas V provides exceptional orbit placement capabilities as demonstrated by the flight-derived orbital injection accuracy data of the Atlas V family of LVs in Tables 2.3.3-2 and 2.3.3-3. Orbital insertion accuracy for Guidance Commanded Shutdown (GCS) missions is listed in Table 2.3.3-2. Since propellant margin is reserved to accommodate LV dispersions and ensure a guidance commanded shutdown, the flight results shown in Table 2.3.3-2 reflect the precision of the Atlas LV guidance and navigation hardware and flight software algorithms. For missions that incorporate Atlas V mission targeting options of IFR, MRS, or combination IFR/MRS, injection accuracy is provided in Table 2.3.3-3 in terms of the difference between the predicted and achieved ideal velocity required to inject from the transfer orbit to GSOs. This method provides a common comparison of flight results for the wide variety of Atlas V LV mission optimization and targeting options. In addition, the  $\Delta V$  to GSO that results from the achieved transfer orbit not only reflects guidance system performance but also includes actual LV performance. As shown in Table 2.3.3-3, the near-zero statistical mean of the Atlas LV flight results demonstrates the accuracy of the Atlas family of LV performance modeling and preflight performance predictions.

### 2.3.3.1 Attitude Orientation and Stabilization

The Guidance, Navigation, and Control (GN&C) system can orient the SC to any desired separation attitude. The guidance system can reference an attitude vector to a fixed inertial frame or a rotating orthogonal frame defined by the instantaneous position and velocity vector. The Reaction Control System (RCS) autopilot incorporates three-axis stabilized attitude control for attitude hold and maneuvering. In addition to a precision

attitude control mode for SC pre-separation stabilization, Centaur can provide a stabilized spin rate to the SC about any desired axis, including arbitrary combinations of vehicle primary axes. The Centaur system can accommodate longitudinal spin rates up to 5.0 rpm, subject to some limitation due to space vehicle mass property misalignments. Spin rates about transverse axes have been demonstrated up to 7 deg/sec. A detailed analysis for each Centaur/SC combination will determine the maximum achievable spin rate. Furthermore, known rates imparted to the SC by the separation system (e.g., due to SC center of gravity offsets) can be compensated for by imparting an equal and opposite rate before the separation event. This pre-compensation feature can improve the final SC pointing, nutation, and transverse rates, subject to spin rate requirements and attitude control constraints.

The extensive capabilities of the GN&C system allow the Centaur to satisfy a variety of SC orbital requirements, including thermal control maneuvers, sun-angle pointing constraints, and telemetry

**Table 2.3.3-1: Typical Injection Accuracies at SC Separation**

Atlas V								
Orbit at Centaur SC Separation				± 3-sigma Errors				
Mission	Apogee km (nmi)	Perigee km (nmi)	Inclination (deg)	Apogee km (nmi)	Perigee km (nmi)	Inclination (deg)	Argument of Perigee (deg)	RAAN (deg)
GTO (Coast ≤ 800 sec)	35,897 (19,383)	195 (105)	25.6	168 (91)	4.6 (2.5)	0.025	0.2	0.22
GTO (Coast ~ 5400 sec)	35,765 (19,312)	4,316 (2,330)	21.7	238 (129)	12.0 (6.5)	0.025	0.37	0.39
Super-Synch	77,268 (41,722)	294.5 (159)	26.4	586 (316)	4.6 (2.5)	0.025	0.32	0.34

transmission maneuvers.

**Table 2.3.3-2: Injection Accuracy Results for IFR, MRS, and IFR/MRS Missions**

Vehicle	Mission	Launch Date	Type	Predicted ΔV to GSO (m/s)	Achieved ΔV to GSO (m/s)	Delta (m/s)
AV-001	Hotbird 6	21-Aug-02	IFR	1,569.4	1,571.6	2.2
AV-011	WGS-1	10-Oct-07	IFR	1,529.2	1,526.4	-2.8
AV-016	WGS-2	03-Apr-09	IFR	1,531.9	1,529.1	-2.8
Mean						-1.1
Standard Deviation						2.9

Table 2.3.3-3: Injection Accuracy Results for GCS Missions

Vehicle	Satellite	Launch Date	Apogee (nmi)			Perigee (nmi)			Inclination (deg)			Argument Perigee (deg)		
			Actual -Target	Predicted 3 $\sigma$	Actual Accuracy ( $\sigma$ )	Actual -Target	Predicted 3 $\sigma$	Actual Accuracy ( $\sigma$ )	Actual -Target	Predicted 3 $\sigma$	Actual Accuracy ( $\sigma$ )	Actual -Target	Predicted 3 $\sigma$	Actual Accuracy ( $\sigma$ )
AV-002	Hellas-Sat	13-May-03	-25.04	232.99	0.32	-0.03	1.24	0.06	-0.000	0.014	-0.086	0.005	0.230	0.061
AV-003	Rainbow 1	17-July-03	-2.15	54.00	0.12	-0.17	5.40	0.09	-0.000	0.020	0.063	-0.003	0.400	0.0204
AV-005	AMC-16	17-Dec-04	-9.01	54.00	0.50	-2.01	6.48	0.93	0.001	0.020	0.114	0.007	0.400	0.051
AV-004	Inmarsat 4 F-1	11-Mar-05	30.61	291.58	0.31	0.43	1.30	1.00	-0.000	0.016	0.079	-0.000	0.280	0.003
AV-008	ASTRA 1KR	20-Apr-06	0.17	59.40	0.01	-1.28	10.80	0.36	-0.001	0.020	0.126	-0.016	0.250	0.197
AV-013	STP-1	08-Mar-07	0.53	107.99	0.01	-0.25	2.70	0.28	0.005	0.100	0.151	*	*	*
AV-015	NROL-24	10-Dec-07	-1.27	70.00	0.05	-0.62	6.00	0.31	0.001	0.100	0.020	0.001	0.400	0.007
AV-006	NROL-28	13-Mar-08	-5.16	54.00	0.29	-0.38	4.86	0.24	0.001	0.100	0.030	0.000	0.100	0.009
AV-014	ICO G1	14-Apr-08	1.14	54.00	0.06	-0.67	5.40	0.37	-0.000	0.030	0.019	-0.002	0.400	0.015

Notes:  
 \* Indicates values not targeted for these missions.

**2.3.3.2 Separation Pointing Accuracies**

Pointing accuracy just before SC separation is a function of guidance system hardware, guidance software, and autopilot attitude hold capabilities. In the non-spinning precision pointing mode, the system can maintain attitude errors less than 0.7 degrees, and attitude rates less than 0.2, 0.2 and 0.25 deg/sec about the pitch, yaw, and roll axes, respectively (prior to SC separation) as shown in Table 2.3.3.2-1. Although the attitude and rates of a non-spinning SC after separation (after loss of contact between the Centaur and the SC) are highly dependent on mass properties of the SC, attitude typically can be maintained within 0.7 degrees per axis; body axis rates are typically less than 0.6 deg/sec in the pitch or yaw axis and 0.5 deg/sec in the roll axis. The angular momentum of the SC after separation is often a parameter of interest. Total SC angular momentum is typically less than 15 N-m-s. Separation conditions for a particular SC are assessed during the mission unique separation analysis.

Centaur can also use a transverse spin separation mode in which an end-over-end "rotation" is initiated before separating the SC. A rotation rate of up to 7 deg/sec is possible about the pitch or yaw axis for typical SC.

Any other axis of spin can be achieved before separation. For example, the spin axis can be aligned with the principal axes of the SC (as provided by the customer). The magnitude of the spin rate achievable for an arbitrary axis will depend upon SC mass properties, and must be determined on a mission-unique basis.

For a mission requiring pre-separation spinup, conditions just before SC separation combine with any tip-off effects induced by the separation system and any SC principal axis misalignments to produce post-separation momentum pointing and nutation errors. Here, nutation is defined as the angle between the actual space vehicle geometric spin axis and the SC momentum vector. Although dependent on actual SC mass properties (including uncertainties) and the spin rate, momentum pointing and maximum nutation errors following separation are typically less than 3.0 and 5.0 degrees, respectively.

The Atlas V Centaur flight control systems have been generically designed to accommodate SC that fall within the range of payload mass properties, correlated with specific vehicle maneuvers, as identified in Table 2.3.3.2-2. The payload mass properties identified in this table include the SC, the payload adapter, SC separation system, and the associated 3-sigma uncertainties. SC that fall outside of these generic design ranges may be accommodated on a mission-unique basis.

**Table 2.3.3.2-1: Guidance and Control Capabilities Summary**

<b>Centaur Coast Phase Attitude Control</b>	
• Roll Axis Pointing, Half Angle	≤ 1.6 deg
• Passive Thermal Control Commanded Rate, (Clockwise or Counterclockwise)	
– Minimum	0.5 deg/sec
– Maximum	1.5 deg/sec
<b>Centaur Separation Parameters at Separation Command (with No Spin Requirement)</b>	
• Pitch, Yaw, Roll Axis Pointing, Half Angle	≤ 0.7 deg
• Body Axis Rates,	
– Pitch	±0.2 deg/sec
– Yaw	±0.2 deg/sec
– Roll	±0.25 deg/sec
<b>SC Separation Parameters at Separation Command (with Transverse Spin Requirement)</b>	
• Transverse Rotation Rate	≤ 7.0 deg/sec
<b>SC Separation Parameters Following Separation (with Non-Spinning or Slow spinning Requirement)</b>	
• Pitch, Yaw & Roll Axis Pointing (per Axis)	≤ 0.7 deg
• Body Axis Rates,	
– Pitch	±0.6 deg/sec
– Yaw	±0.6 deg/sec
– Roll	±0.5 deg/sec
<b>SC Separation Parameters Following Separation (with Longitudinal Spin Requirement)</b>	
• Nutation, Half Angle	≤ 5.0 deg
• Momentum Pointing, Half Angle	≤ 3.0 deg
• Spin Rate,	≤ 30.0 ±3.0 deg/sec
<u>Note:</u> Capabilities are subject to SC mass properties limitations.	



Table 2.3.3.2-2: Design Range of Payload Mass Properties

Atlas V Config.	Pre-SC Separation Maneuver	SC Mass, kg (lb)	Forward cg Location, * mm (in.)	Lateral cg Offset, mm (in.)	Moments of Inertia, kg-m <sup>2</sup> (slug-ft <sup>2</sup> )	Products of Inertia, kg-m <sup>2</sup> (slug-ft <sup>2</sup> )
SEC	5-rpm Longitudinal Axis Spin	910-5,670 (2,000-12,500)	1,016-4,572 (40-180) **	±12 (±0.5)	lxx= 410-5,420 (300-4,000) lly= 390-9,490 (285-7,000) lzz= 39-9,490 (285-7,000)	lxy= ± 68 (± 50) lxz= ± 68 (± 50) lyz= ± 340 (± 250)
DEC	5-rpm Longitudinal Axis Spin	4,080-5,670 (9,000-12,500)	1,778-4,572 (70-180) **	±12 (±0.5)	lxx= 2,580-5,420 (1,900-4,000) lly= 2,030-9,490 (1,500-7,000) lzz= 2,030-9,490 (1,500-7,000)	lxy= ± 68 (± 50) lxz= ± 68 (± 50) lyz= ± 340 (± 250)
All	7-deg/s Transverse Axis Spin	1,810-5,670 (4,000-12,500)	1,016-3,302 (40-130)	±76 (±3)	lxx= 1,080-5,420 (800-4,000) lly= 1,360-9,490 (1,000-7,000) lzz= 1,360-9,490 (1,000-7,000)	lxy= ± 135 (± 100) lxz= ± 135 (± 100) lyz= ± 135 (± 100)
400 Series	3-Axis Stabilized Attitude Hold	910-9,070 (2,000-20,000)	1,016-4,572 (40-180)	±127 (±5)	lxx= 410-10,850 (300-8,000) lly= 390-27,100 (285-20,000) lzz= 390-27,100 (285-20,000)	lxy= ± 910 (± 670) lxz= ± 910 (± 670) lyz= ± 910 (± 670)
500 Series	3-Axis Stabilized Attitude Hold	1,360-19,050 (3,000-42,000)	1,016-5,715 (40-225)	±127 (±5)	lxx= 680-40,700 (500-30,000) lly= 1,020-258,000 (750-190,000) lzz= 1,020-258,000 (750-190,000)	lxy= ± 2,700 (± 2,000) lxz= ± 2,700 (± 2,000) lyz= ± 2,700 (± 2,000)
<p><b>Notes:</b>                      * Longitudinal cg location is tabulated as inches forward of the forward ring of the Centaur forward adapter.                      ** Longitudinal cg position is constrained as a function of payload mass. Payload longitudinal cg position is restricted to 2,540 mm (100 in.) above the forward ring of the Centaur forward adapter for a 2,630.8 kg (5,800-lbm) sc. Linear interpolation from this point to extreme points is used.                      By definition, the x-axis is the Centaur longitudinal axis with positive direction measured forward. The y-axis is the Centaur pitch axis, and the z-axis is the Centaur yaw axis.</p>						

**2.3.3.3 Separation System**

The relative velocity between the SC and the Centaur is a function of the mass properties of the separated SC and the separation mechanism. The Atlas V separation systems are designed to preclude recontact between the SC and Centaur and provide adequate separation for collision and contamination avoidance. Typically, the separation system achieves at least 0.27 m/sec (0.9 ft/sec) relative separation velocity.

## 2.4 ATLAS V SEQUENCE OF EVENTS

### 2.4.1 Mission Timelines

To familiarize users with Atlas V mission sequences, information is provided in the following table and figures regarding typical Atlas V mission designs. Table 2.4.1-1 shows the mission sequence data for a typical Atlas V 401 GTO mission, Atlas V 401 LEO mission, Atlas V 521 Standard GTO mission, Atlas V 521 Extended Coast GTO mission, Atlas V 521 3-Burn mission, and Atlas V HLV GSO mission, respectively.

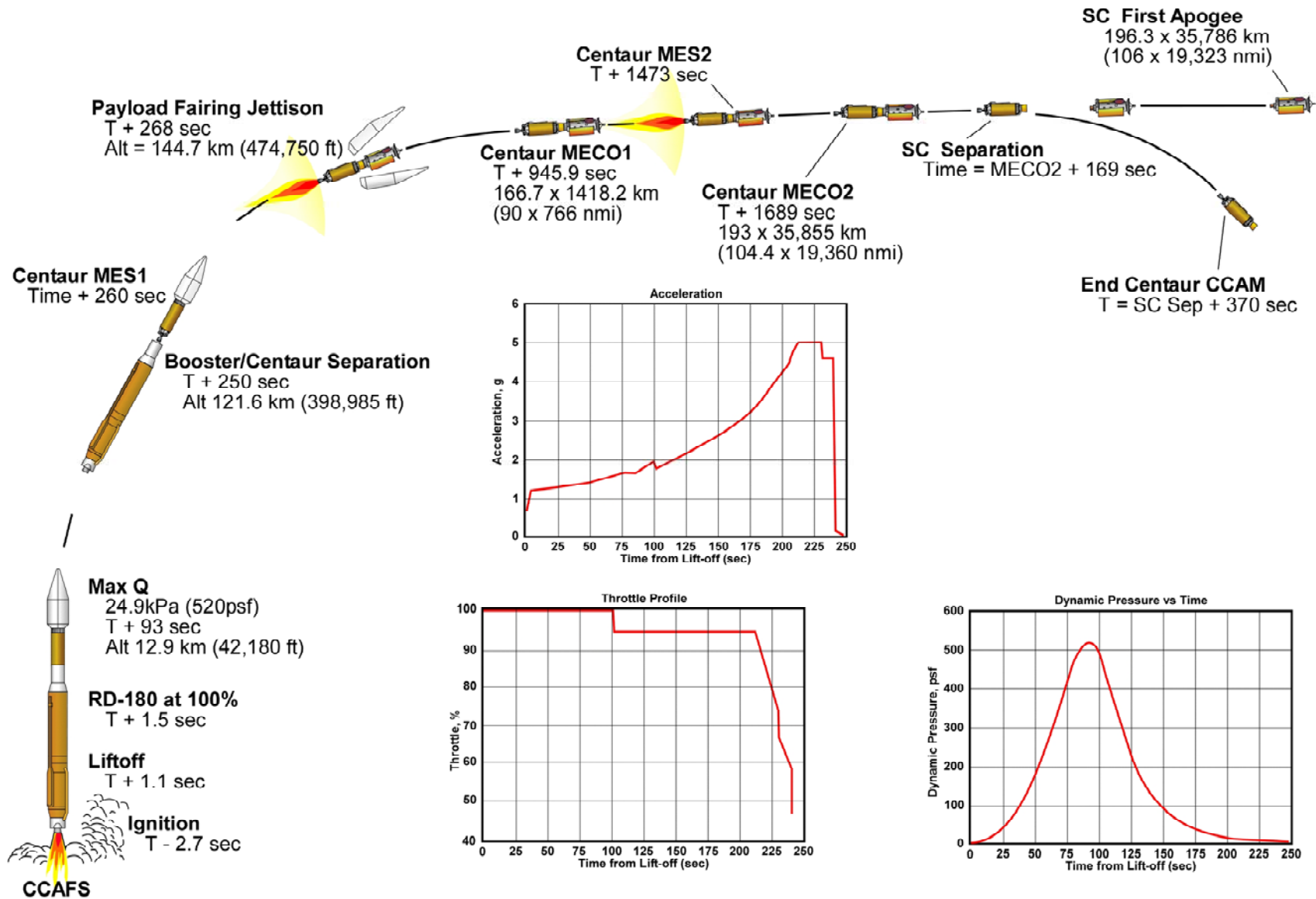
### 2.4.2 Ascent Profiles

Figures 2.4.2-1 through 2.4.2-6 show corresponding sequences-of-events for the Atlas V 400 series, 500 series, and HLV timelines.

**Table 2.4.1-1: Typical Atlas V LV Mission Sequence Timeline**

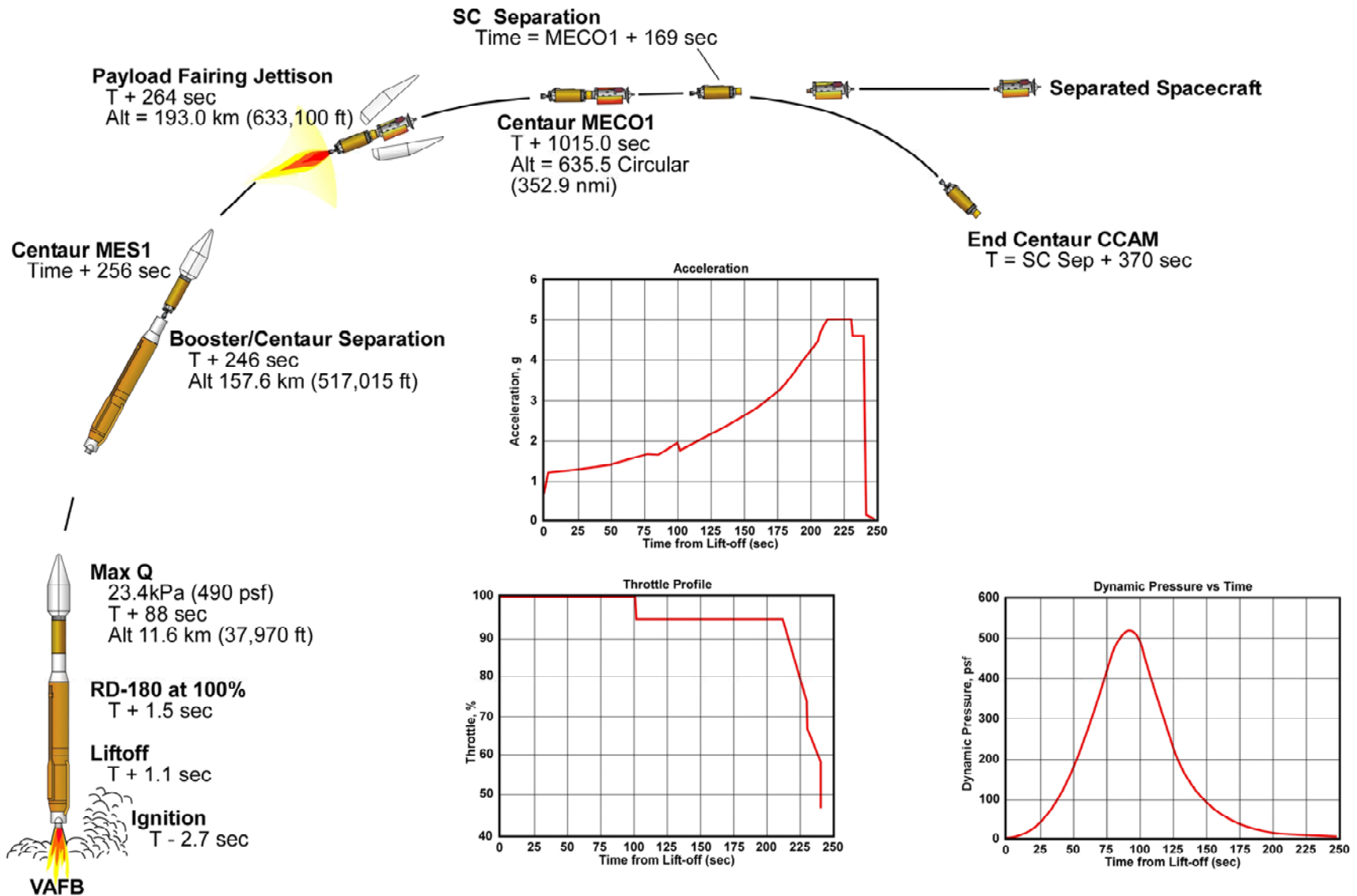
Atlas V Mission Sequence	401 Standard GTO	401 LEO Sun-synch	521 Standard GTO	521 Extended Coast GTO	521 3-Burn GSO	HLV GSO
(Time from T-0)	(sec)	(sec)	(sec)	(sec)	(sec)	(sec)
Guidance Go-Inertial	-8	-8	-8	-8	-8	-8
RD-180 Ignition	-2.7	-2.7	-2.7	-2.7	-2.7	-2.7
RD-180 Engine Ready (T-0)	0.0	0.0	0.0	0.0	0.0	0.0
SRB Ignition	--	--	0.8	0.8	0.8	--
Liftoff	1.10	1.10	1.05	1.04	1.04	0.97
Atlas booster Throttle Down/Up for max Q	--	--	38/58	39/57	41/57	59/312*
Strap-on SRB Jettison	--	--	118	116	117	--
LRB Engine Cutoff	--	--	--	--	--	228
LRBs Jettison	--	--	--	--	--	236
PLF Jettison (500 series and HLV)	--	--	212	206	210	298
Atlas Booster Engine Cutoff (BECO)	242	238	249	251	252	367
Atlas Booster/Centaur Separation	250	246	257	259	260	375
Centaur Main Engine Start 1 (MES1)	260	256	267	269	270	385
PLF Jettison (400 series)	268	264	--	--	--	--
Centaur Main Engine Cutoff (MECO1)	946	1,015	904	1,041	782	563
Start Turn to MES2 Attitude	1,103	--	1,032	7,871	983	818
MES2	1,473	--	1,402	8,241	1,353	1,188
MECO2	1,689	--	1,668	8,373	1,617	1,678
Start Turn to MES3 Attitude	--	--	--	--	19,893	19,957
MES3	--	--	--	--	20,263	20,327
MECO3	--	--	--	--	20,391	20,543
Start Alignment to Separation Attitude	1,691	1,017	1,670	8,375	20,393	20,545
Separate SC	1,858	1,184	1,837	8,542	20,560	20,712
Start Turn to CCAM Attitude	1,883	1,209	1,862	8,567	20,585	20,737
Centaur End of Mission	6,258	5,584	6,237	12,942	24,960	25,112
<b>Note:</b>						
* HLV Atlas booster throttling is for performance efficiency and not for max Q control.						

Figure 2.4.2-1: Typical Atlas V 401 Standard Short-Coast GTO Ascent Profile



AVUG11\_F020402\_01b

Figure 2.4.2-2: Typical Atlas V 401 Standard LEO Sun-Synchronous Ascent Profile



AVUG11\_F020402\_02b

Figure 2.4.2-3: Typical Atlas V 521 Standard Short-Coast GTO Ascent Profile and Ground Trace (1 of 2)

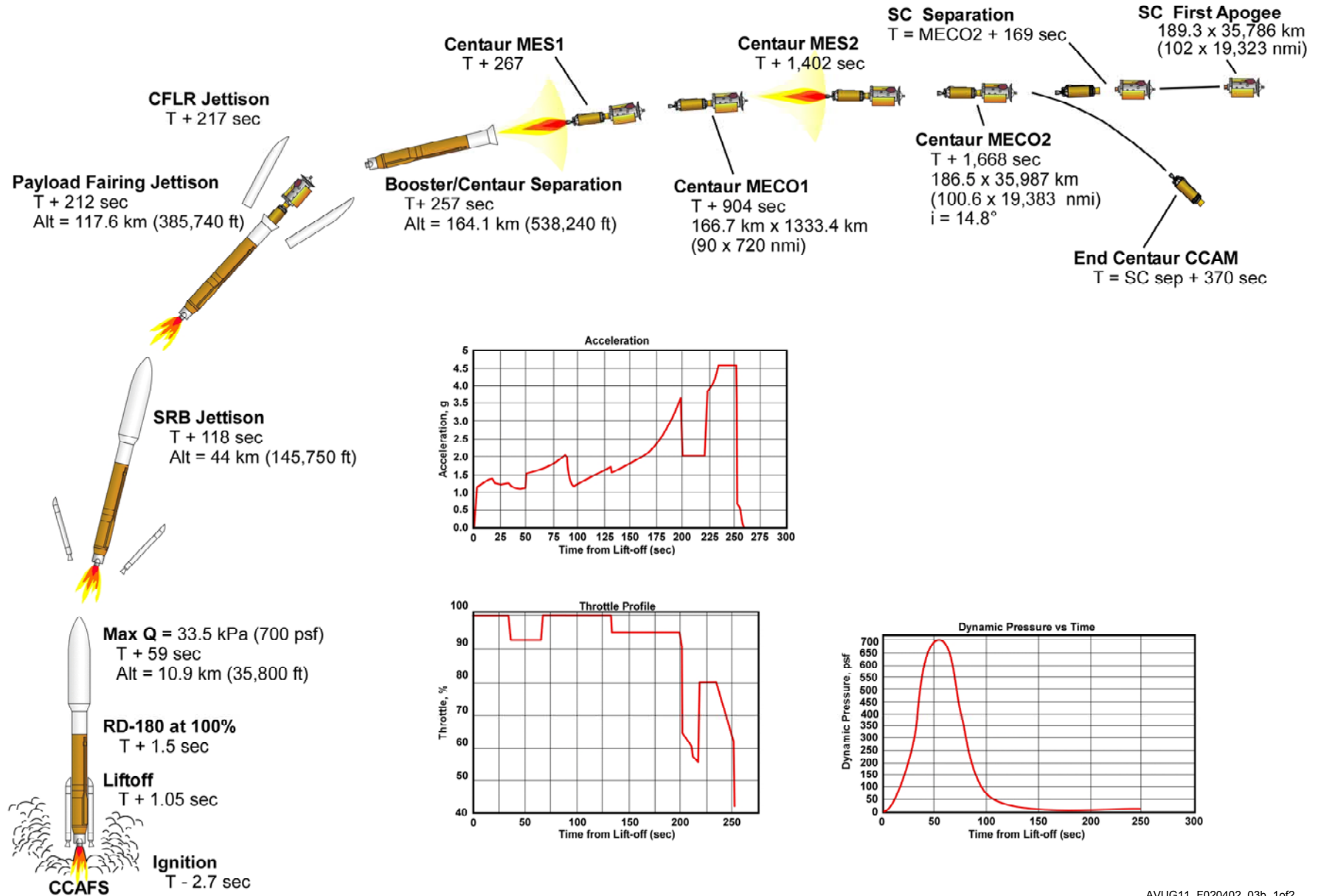


Figure 2.4.2-3: Typical Atlas V 521 Standard Short-Coast GTO Ascent Profile and Ground Trace (2 of 2)

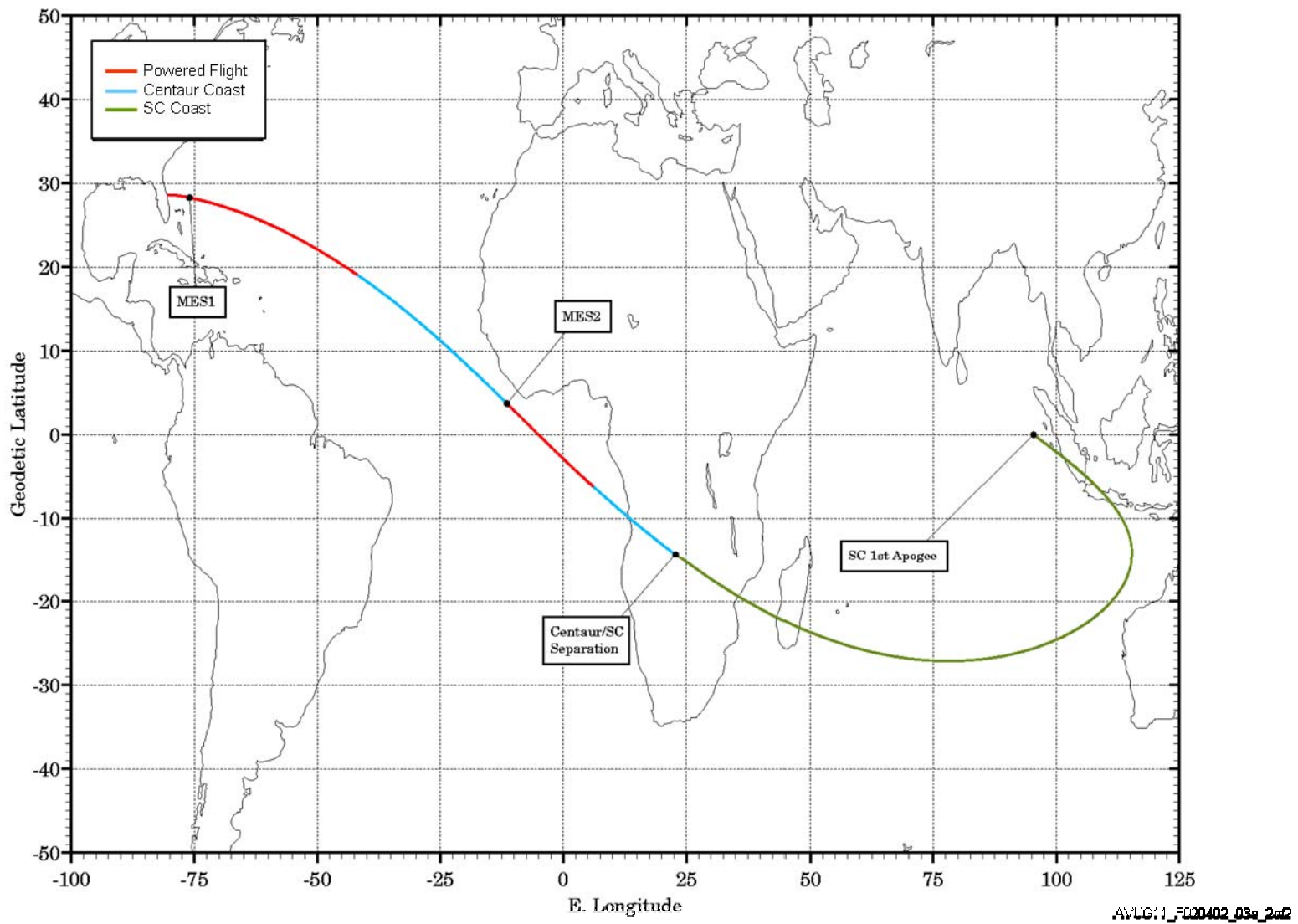
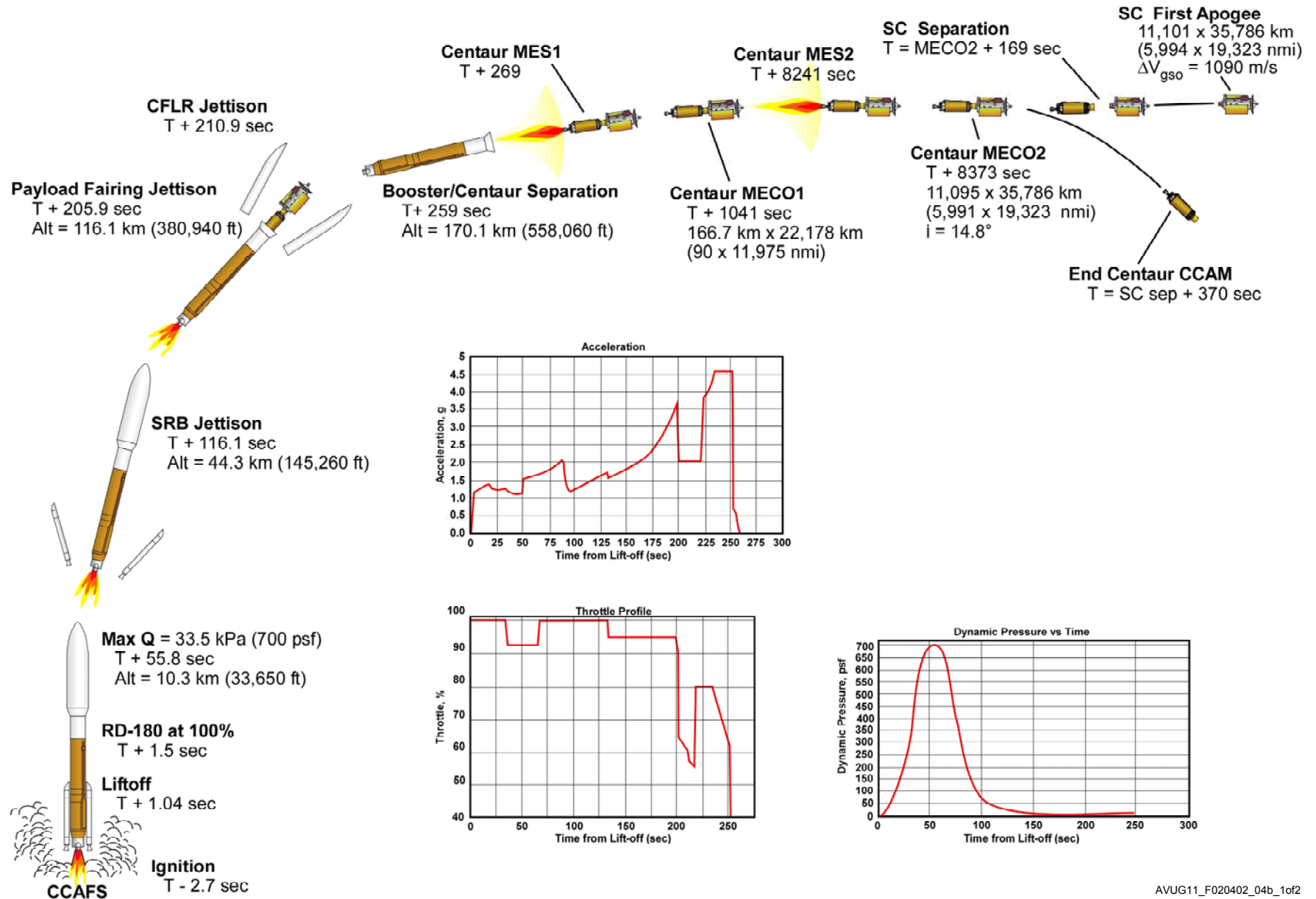


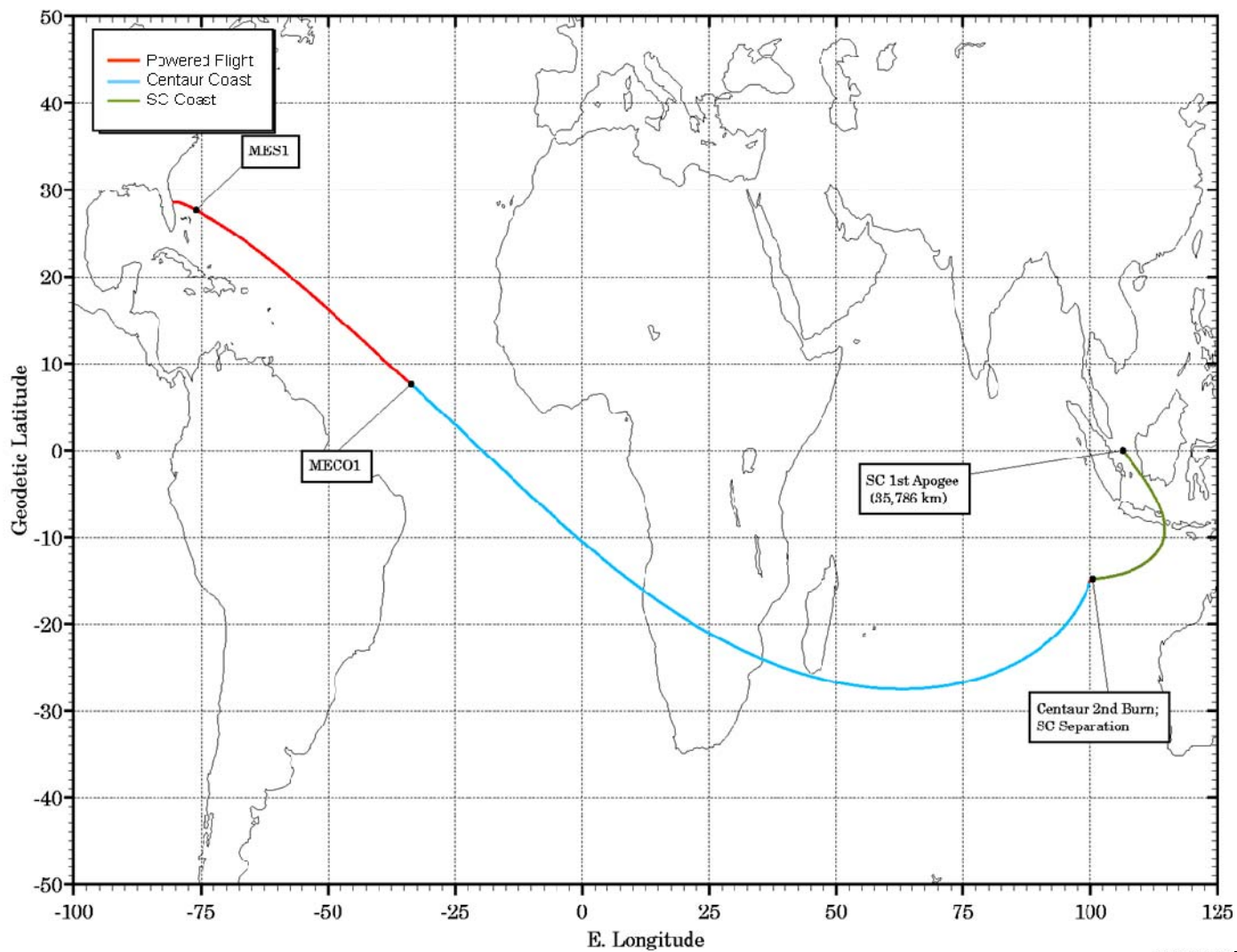
Figure 2.4.2-4: Typical Atlas V 521 Extended Coast GTO Ascent Profile and Ground Trace (1 of 2)



AVUG11\_F020402\_04b\_1of2



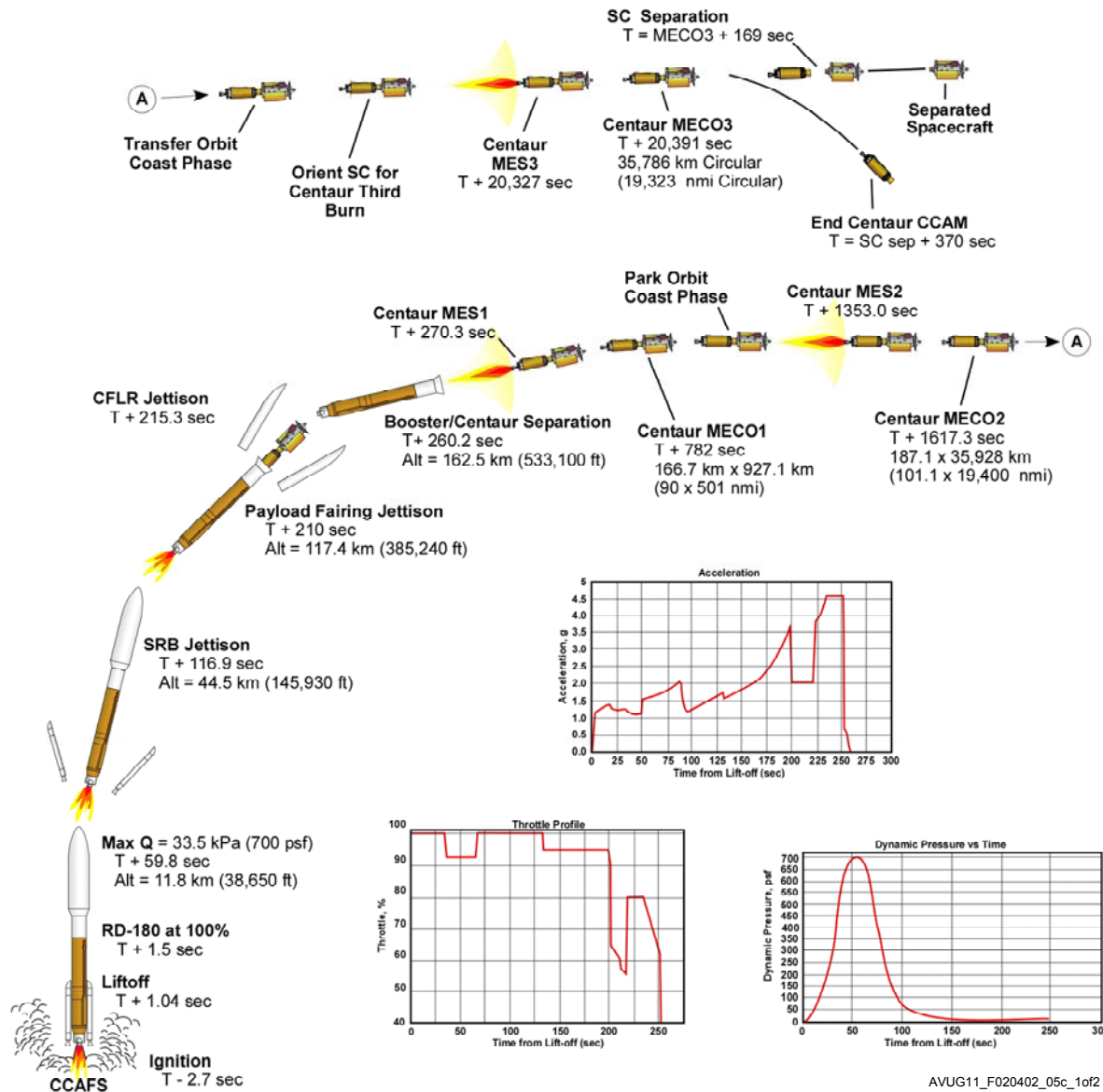
Figure 2.4.2-4: Typical Atlas V 521 Extended Coast GTO Ascent Profile and Ground Trace (2 of 2)



AVJG11\_F0204C2\_04a\_2of2



Figure 2.4.2-5: Typical Atlas V 521 3-Burn GSO Ascent Profile (1 of 2)



AVUG11\_F020402\_05c\_1of2

Figure 2.4.2-5: Typical Atlas V 521 3-Burn GSO Ground Trace (2 of 2)

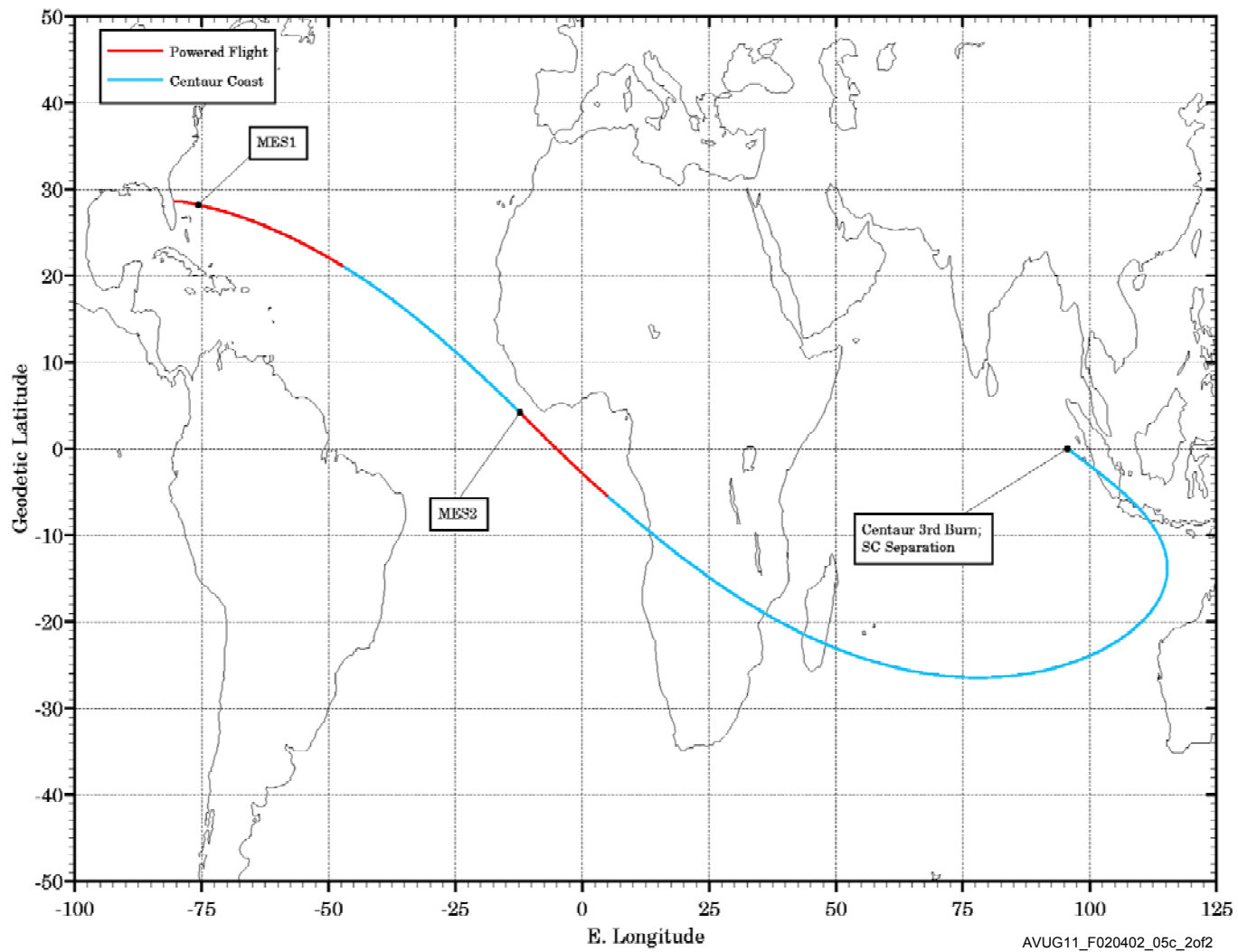
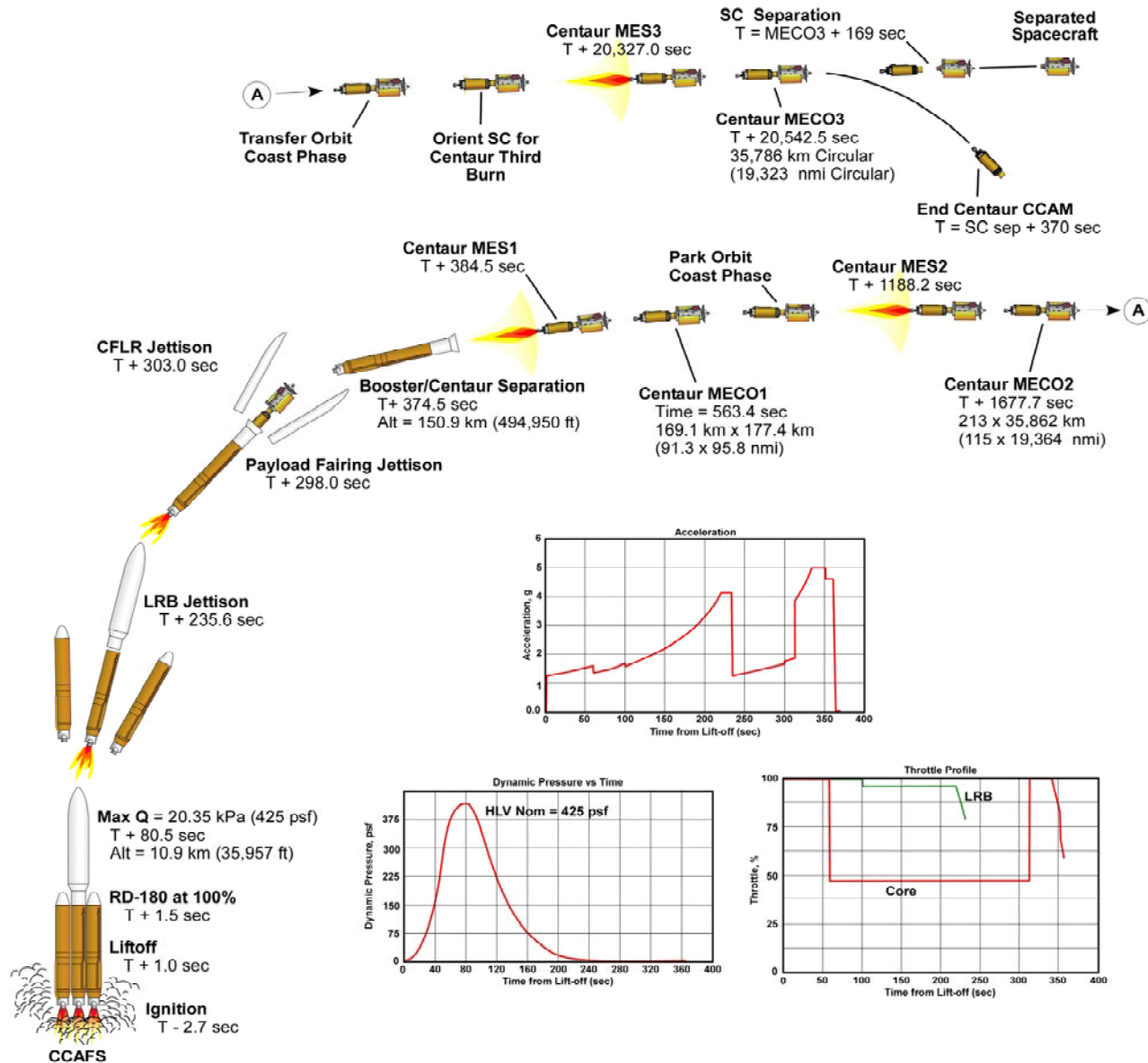


Figure 2.4.2-6: Typical Atlas HLV GSO Ascent Profile



## 2.5 PERFORMANCE GROUND RULES

Atlas V performance ground rules for various missions that launch from CCAFS in Florida or VAFB in California are described in this section.

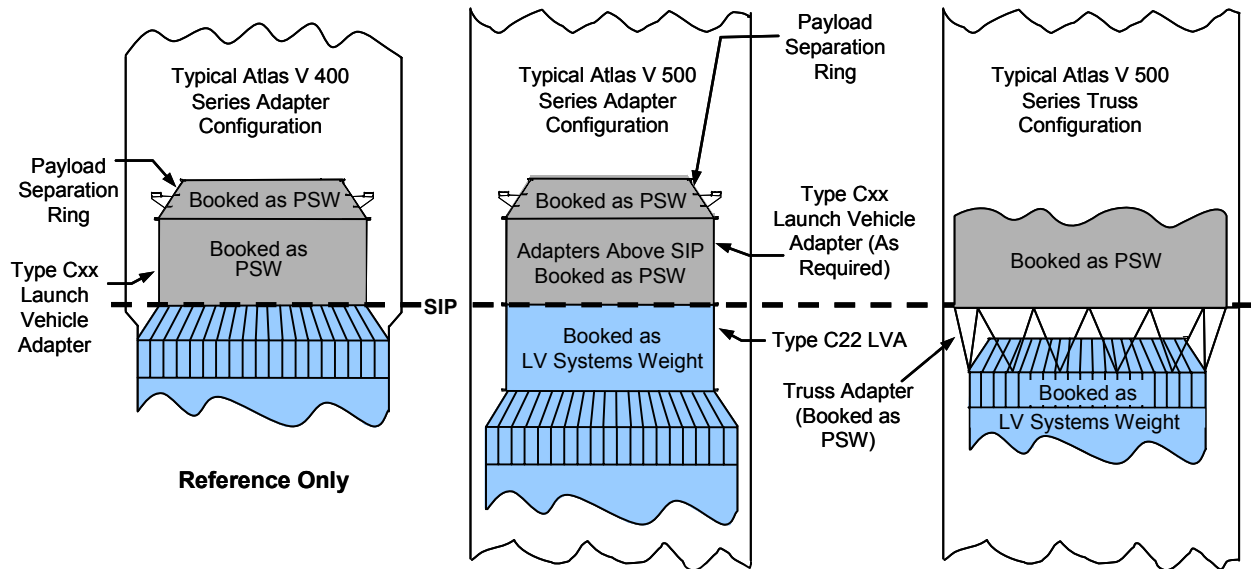
### 2.5.1 Payload Systems Weight Definition

Performance capabilities quoted throughout this document are presented in terms of Payload Systems Weight (PSW). PSW is defined as the separated SC, the SC-to-LV adapter, and other mission-unique hardware required on the LV to support the SC. Table 2.5.1-1 provides masses for Atlas V standard payload adapters (reference Section 5 for payload adapter details). Data are also provided for estimating performance effects of various LV Mission Peculiar (LVMP) hardware requirements. As a note, PLF performance effects shown (SC mass-equivalent) are approximate. Please contact ULA for the effect of mission unique ground rules such as higher park orbit perigees, spacecraft constraints on axial acceleration, heat flux at PLF jettison, non-standard Arguments of Perigee, etc. The LV trajectory, SC mass, and mission target orbit can affect the performance contributions of each mission-unique item. Figure 2.5.1-1 illustrates the PSW definition.

**Table 2.5.1-1: Performance Effects of SC Required Hardware**

Item	Configuration	Mass, kg (lb)
<b>Payload Separation Ring (PSR) with LSPSS</b>		
Type A937	937 mm ( 36.88 inches) diameter	47.8 (105)
Type B1194	1194 mm (47.01 inches) diameter	39.9 (88)
Type D1666	1666 mm (65.59 inches) diameter	39.5 (87)
<b>Launch Vehicle Adapter (LVA)</b>		
C13	(0.140" Wall Thickness)	21.9 (48)
C15	(0.200" Wall Thickness)	42.3 (93)
C22	(0.120" Wall Thickness)	32.2 (71)
C22	(0.140" Wall Thickness)	36.5 (81)
C22	(0.200" Wall Thickness)	56.5 (125)
C25	(0.180" Wall Thickness)	48.9 (108)
C29	(0.120" Wall Thickness)	39.9 (88)
C29	(0.200" Wall Thickness)	66.6 (147)
<b>Truss Adapter</b>		
T4394	4,394.2 mm (173 in) diameter	170 to 181.4 (375 to 400)
T3302	3,302 mm (130 in) diameter	170 to 181.4 (375 to 400)
<b>Other SC Required Hardware</b>		
PLF Acoustic Panels	LPF	11 (25)
PLF Thermal Shield	LPF	4 (9)
Environmental Verification Package	Telepak, Instruments	9 (20)
Centaur Standard Package	Flight Termination System Airborne Harness	8 (18)
PLF Standard Package	Two Standard Access Doors Reradiating Antenna PLF Customer Logo	Included in PLF Effect
<b>LVMP Performance Effects</b>		
	<b>Performance Ratio</b>	
Centaur Hardware	100%	
PLF Hardware	15%	

Figure 2.5.1-1: Payload Systems Weight Definition



AVUG11\_F020501\_01d

## 2.5.2 Payload Fairing Performance Effects

### 2.5.2.1 Atlas V 400 Series

Atlas V 400 series performance is based on the use of the 4-m EPF. GTO performance with the LPF is approximately 35 kg (77.2 lb) more than the EPF with the 401 configuration and 44 kg (97 lb) more with the 431 configuration. GTO performance with the XEPF is approximately 35 kg (77.2 lb) less than the EPF with the 401 configuration and 44 kg (97 lb) less with the 431 configuration.

### 2.5.2.2 Atlas V 500 Series

Atlas V 500 series performance is based on the use of the 5-m short PLF. For SC that require greater volume (height), the 5-m medium and long PLFs are available. For Atlas V 500 series configurations that use the 5-m medium PLF, the typical range of performance degradation is 61 kg (133 lb) for the Atlas V 511 and 521, to 40 kg (88 lb) for the Atlas V 531 through 551 for GTO missions. For Atlas V 500 series configurations that use the 5-m long PLF, the typical range of performance degradation is 89 kg (197 lb) for the Atlas V 511 and 521, to 70 kg (155 lb) for the Atlas V 531 through 551 for GTO missions. Additional payload fairing information can be found in Section 6.

### 2.5.2.3 Atlas V HLV

Atlas V HLV performance is based on use of the 5-m long PLF, although both short and medium payload fairings are available for SC that require less volume (height).

## 2.5.3 LV Performance Confidence Levels

Atlas V missions are targeted to meet the requirements of each user. Historically, commercial Atlas missions have been designed with a 2.33-sigma performance confidence level (99% probability of achieving target orbit elements within guidance injection accuracy). With the flexibility of Atlas/Centaur hardware and flight software, confidence levels can be set based on each mission's requirements. The MRS performance option, discussed earlier in this section, takes full advantage of this concept.

#### 2.5.4 Centaur Short Burn Performance Considerations

For LEO mission applications, United Launch Alliance has evaluated LV requirements for short-duration Centaur second burns. With missions requiring short-duration second burns (10-30 seconds), propellant residuals will be biased to ensure proper engine propellant inlet conditions. Centaur main engine burns as short as 10 seconds are possible. All performance data shown using short-duration burns include performance effects of propellant level control.

#### 2.5.5 Centaur Coast Performance Considerations

The standard Centaur incorporates park orbit coasts as short as 8 minutes and as long as 2 hours. The minimum coast time is constrained by Centaur propellant settling and conditioning requirements. A shorter coast time could be implemented on a mission-unique basis, if required. No additional hardware would be required, but vehicle turn angles may be limited. Longer coast times can also be accommodated although hardware changes are required. A Centaur GSO Kit is required to support Centaur long-coast durations. For the Atlas V 400 series this includes the addition of two 150 amp-hour main vehicle batteries. For some long-coast missions that also incorporate long first Centaur burns, white paint may be required for the Centaur tank sidewalls. This assumption was not included in the long-coast performance data.

For the Atlas V 500 series vehicles, the GSO Kit consists of the same additional battery power and Centaur LH2 tank sidewall radiation shield. Coasts of up to 6 hours in duration and/or Centaur three-burn missions are achievable with these GSO Kit items.

#### 2.5.6 Heavy SC Lift Performance Considerations

The Atlas can structurally accommodate missions with spacecraft weights up to approximately 20,000 lbs, depending on the payload adapter selected and the coupled loads analysis results for the specific mission. Structural capabilities for the Standard Interface Plane, Launch Vehicle Adapters and the available Payload Adapters are provided in Section 5.1.2, 5.1.3 and 5.1.4 respectively. The capabilities provided are based load factors that may be overly conservative for a mission between 10,000 lbs and 20,000 lbs, and therefore, mission specific loads analysis may show lower load factors, which results in higher capabilities.

For spacecraft weights that are in the range of 20,000 lbs to 45,000 lbs, mission unique launch vehicle analysis and development may be required, so please contact ULA. These spacecraft may also require a truss interface. Details on the truss interfaces are provided in Section 5.1.5.

### 2.6 ATLAS V PERFORMANCE CAPABILITY

ULA offers a broad range of performance levels for the Atlas V series of LVs as illustrated in Table 2.6-1.

#### 2.6.1 Short-Coast Subsynchronous and Supersynchronous Geo-Transfer Capability

The optimum trajectory profile for achieving these transfer orbits is the parking orbit ascent. The 27 degree inclined orbit missions are launched at flight azimuths that have been approved and flown. The Centaur second burn is executed near the first descending node of the parking orbit (near the equator). Performance data are shown for a 2.33  $\sigma$  GCS for a transfer orbit apogee inclination of 27 degrees.

Figure 2.6.1-1 with Table 2.6.1-1 illustrates the performance of the Atlas V 401 through 431 LVs to geo-transfer orbits of various apogees. Figure 2.6.1-2 with Table 2.6.1-2 illustrates the performance of the Atlas V 501 through 551 LVs to geo-transfer orbits of various apogees.

Table 2.6-1: Atlas V 400/500 Series and HLV Performance Capabilities Summary

Orbit Type ( $\Delta V$ to GSO)	400 Series				500 Series					HLV	
	Number of Solid Rocket Boosters										
	0	1	2	3	0	1	2	3	4	5	N/A
	Payload Systems Weight (PSW), kg (lb)										
GTO (1804 m/s)	4,750 (10,470)	5,950 (13,110)	6,890 (15,180)	7,700 (16,970)	3,775 (8,320)	5,250 (11,570)	6,475 (14,270)	7,475 (16,470)	8,290 (18,270)	8,900 (19,620)	13,000 (28,660)
GTO (1500 m/s)	3,460 (7,620)	4,450 (9,810)	5,210 (11,480)	5,860 (12,910)	2,690 (5,930)	3,900 (8,590)	4,880 (10,750)	5,690 (12,540)	6,280 (13,840)	6,860 (15,120)	--
GSO	--	--	--	--	--	--	2,632 (5,802)	3,192 (7,037)	3,630 (8,003)	3,904 (8,608)	6,454 (14,229)
LEO I =28.5 deg	9,797* (21,598)	12,150* (26,787)	14,067* (31,012)	15,718* (34,653)	8,123 (17,908)	10,986 (24,221)	13,490 (29,741)	15,575 (34,337)	17,443 (38,456)	18,814 (41,478)	29,400* (64,816)*
LEO Sun-sync	7,724 (17,028)	8,905 (19,633)	10,290 * (22,687)	11,704 * (25,803)	6,424 (14,163)	8,719 (19,223)	10,758 (23,717)	12,473 (27,498)	14,019 (30,908)	15,179 (33,464)	--
<b>Atlas V 400 Series</b>					<b>Atlas V 500 Series and HLV</b>						
<ul style="list-style-type: none"> <li>All Performance is SEC</li> <li>Quoted Performance is with 4-m EPF</li> </ul>					<ul style="list-style-type: none"> <li>All Performance is SEC</li> <li>Quoted Performance is with 5-m Short PLF</li> <li>HLV LEO Performance is DEC</li> <li>HLV Quoted Performance is with 5-m Long PLF</li> </ul>						
* For 400 series, PSW above 9,072 kg (20,000 lb) may require mission-unique accommodations. For 500 series and HLV, PSW above 19,051 kg (42,000 lb) may require mission-unique accommodations.											
<b>Notes:</b>											
GTO (1804 m/s): $\geq 185 \times 35,786$ km ( $\geq 100 \times 19,323$ nmi), Inclination = 27.0 deg, Argument of Perigee = 180 deg, CCAFS											
GTO (1500 m/s): Apogee Height = 35,786 km (19,323 nmi), Argument of Perigee = 180 deg, CCAFS											
GSO: 35,786 km Circular (19,323 nmi Circular), Inclination = 0 deg, CCAFS											
LEO 28.5 deg: 200 km (108 nmi) Circular, CCAFS											
LEO Sun-sync: 200 km (108 nmi) Circular, VAFB											
GCS: Guidance Commanded Shutdown, 2.33 sigma for CCAFS, and for VAFB											

**2.6.2 Short-Coast Standard Geo-transfer with Reduced Inclination Capability**

Performance to orbit degrades on Atlas V vehicles for inclinations other than 27 degrees mostly due to the out of plane steering required to inject the vehicle into the desired final inclination. Performance data are shown for a 2.33  $\sigma$  GCS for a transfer orbit apogee altitude of 35,786 km (19,323 nmi).

Figure 2.6.2-1 with Table 2.6.2-1 illustrates the performance of the Atlas V 401 through 431 LVs to geo-transfer orbits of various inclinations. Figure 2.6.2-2 with Table 2.6.2-2 illustrates the performance of the Atlas V 501 through 551 LVs to geo-transfer orbits of various inclinations.

**2.6.3 Minimum Delta-V to Geosynchronous Orbit ( $\Delta V$  to GSO) Performance Data**

For many missions, SC have limited propellant capability and need to be injected closer to GSO than our standard transfer orbit to achieve the required on-orbit lifetimes. For those missions, a mission design that minimizes the  $\Delta V$  to GSO remaining for a given PSW will provide the best mission design/maximum on-orbit lifetime. A number of cases are presented for Delta-Vs from 1,200 m/s to 1,700 m/s for the Atlas V 400 and 500 series vehicles. Depending on the maximum apogee capability of the SC, varying performance can be achieved. Performance data shown in this section reflect the super-synchronous (with inclination reduction) and extended-coast mission design options.

Table 2.6.3-1 summarizes the Atlas V 401-431 LVs minimum  $\Delta V$  to GSO with various PSW. Figures 2.6.3-1a through 2.6.3-1d with Tables 2.6.3-1a through 2.6.3-1d depict the Atlas V 401-431 LVs minimum  $\Delta V$  to GSO with a GSO apogee cap (35,786 km). Table 2.6.3-2 summarizes the Atlas V 501-551 LVs minimum  $\Delta V$  to GSO with various PSW. Figures 2.6.3-2a through 2.6.3-2f with Tables 2.6.3-2a through 2.6.3-2f depict the Atlas V 501-551 LVs minimum  $\Delta V$  to GSO with a GSO apogee cap (35,786 km).

Using the three-burn geo-transfer injection design, Table 2.6.3-3 summarizes the Atlas V 521-551 LVs minimum  $\Delta V$  to GSO with various PSW. Figure 2.6.3-3 with Tables 2.6.3-3a through 2.6.3-3d depict the Atlas V 521-551 LVs minimum  $\Delta V$  to GSO.

#### 2.6.4 Earth-Escape Performance Capability

Centaur's heritage as a high-energy upper stage makes it ideal for launching SC into Earth-escape trajectories. For the Atlas V 400 and 500 series LVs, an optional vehicle configuration uses the parking orbit ascent design with a customer-supplied third stage. This vehicle configuration is advantageous for missions that require a very high-energy Earth departure, cases in which vehicle staging effects make it more efficient for a third stage to provide an additional energy increment. Please contact ULA for additional information for a performance assessment on Earth-escape capability.

#### 2.6.5 CCAFS Low-Earth Orbit Capability

Atlas V can launch SC into a wide range of LEOs from CCAFS using direct ascent or parking orbit ascent mission profiles.

Figure 2.6.5 shows inclinations from 28.5 degrees up to 55 degrees or even higher are possible with the direct ascent. Direct ascent performance to inclinations greater than 55 degrees or less than 28.5 degrees are also possible using plane steering techniques.

Figure 2.6.5-1 and 2.6.5-1a through 2.6.5-1d show LEO performance for Atlas V 401 through 431 from CCAFS from 200 km to 2,000 km circular. Figure 2.6.5-2 and Figures 2.6.5-2a through 2.6.5-2c illustrate LEO performance from 200 km to 2,000 km for the 501 through 551 configurations from CCAFS.

**Direct Ascent to Elliptical Orbit** — Elliptical orbit performance capability is accomplished using the direct ascent with perigee altitude at or above 185 km (100 nmi). Similar Range Safety and orbital mechanics constraints limit inclinations available with a CCAFS launch.

**Parking Orbit Ascent to Circular Orbit** — SC delivery to low-altitude circular orbit can be accomplished using the two Centaur burn mission profile. The first Centaur burn is used to inject the Centaur and SC into an elliptic parking orbit. A park orbit perigee altitude of 167 km (90 nmi) is assumed for the reference cases. Higher perigee park orbits can be implemented as required. The second Centaur burn will circularize the SC into the desired orbit altitude.

High inclination orbits (inclinations greater than 55 degrees) impose Range Safety restrictions that require the Atlas V LV to meet Instantaneous Impact Point (IIP) constraints along the Eastern seaboard of the United States and Canada. Additional inclination is added in the later stages of the Centaur first burn and the Centaur second burn. High inclination orbit performance capabilities ( $\geq 63.4$  deg) are more optimally achieved when launched from VAFB.

Circular orbit performance capabilities for altitudes between 500 km (270 nmi) and 2,000 km (1,080 nmi) are shown in Figure 2.6.4-1 for 28.5 degree inclination for the Atlas V 401 through 431 LVs. Figure 2.6.4-2 and Table 2.6.4-2 show the same data for the Atlas V 500 series configurations.



### 2.6.6 VAFB LEO Capability

Atlas V can launch SC into a wide range of LEOs from VAFB with inclinations ranging from 63.4 degrees through Sun-synchronous to retrograde using direct ascent or parking orbit ascent mission profiles.

Figure 2.6.6-1 and Figures 2.6.6-1a through 2.6.6-1d show LEO performance for Atlas V 401 through 431 from VAFB from 200 km to 2,000 km circular orbits. Figure 2.6.6-2 and Figures 2.6.6-2a through 2.6.6-2f illustrate LEO performance from 200 to 2,000 km for the 501 through 551 configurations from VAFB.

**Direct Ascent to Circular Orbit** — Circular orbit PSW capability to LEO is accomplished using the one Centaur burn mission profile. The maximum capability is available with a 63.4 degree inclination orbit. Inclinations from 63.4 degrees and higher are possible with the direct ascent from VAFB.

**Direct Ascent to Elliptical Orbit** — Elliptical orbit performance capability is accomplished using the direct ascent with perigee altitude at or above 185 km (100 nmi).

**Parking Orbit Ascent to Circular Orbit** — SC delivery to low-altitude circular orbit can be accomplished using the two Centaur burn mission profile. The first Centaur burn is used to inject the Centaur and SC into an elliptic parking orbit. A park orbit perigee altitude of 167 km (90 nmi) is assumed for the reference cases. Higher perigee park orbits can be implemented as required. Expected parking orbit coast durations may require use of the Centaur GSO Kit. The second Centaur burn will circularize the SC into the desired orbit altitude.

### 2.6.7 Intermediate Circular Orbit Capability

Similar ground rules apply to intermediate circular orbit data (altitudes between ~500 km (270 nmi) and >9,000 km (>4,860 nmi)) as to LEO circular orbit data.

### 2.6.8 VAFB Elliptical Orbit Transfer Capability

Atlas V can launch SC into high-inclination elliptical transfer orbits from SLC-3E at VAFB. Transfer orbits at 63.4 degrees are of interest because the rotation rate of the line of apsides is zero. These missions use a parking orbit ascent mission profile with the Centaur second burn executed near the first antinode (argument of perigee equaling 270 degrees).

### 2.6.9 VAFB High-Inclination, High-Eccentricity Orbit Capability

Atlas V can insert SC into orbits with 12-hour or 24-hour periods at an inclination of 63.4 degrees by launching from VAFB. With the rotation rate of the line of apsides being zero, these orbits repeat their ground trace. These missions use a park orbit ascent mission similar to that described in Section 2.6.6.

The following sections contain the figures and tables described herein and are arranged by Mission Category.

Figure 2.6.1-1: Atlas V 401-431 Apogee Variation Performance to Geo-transfer Orbit — CCAFS

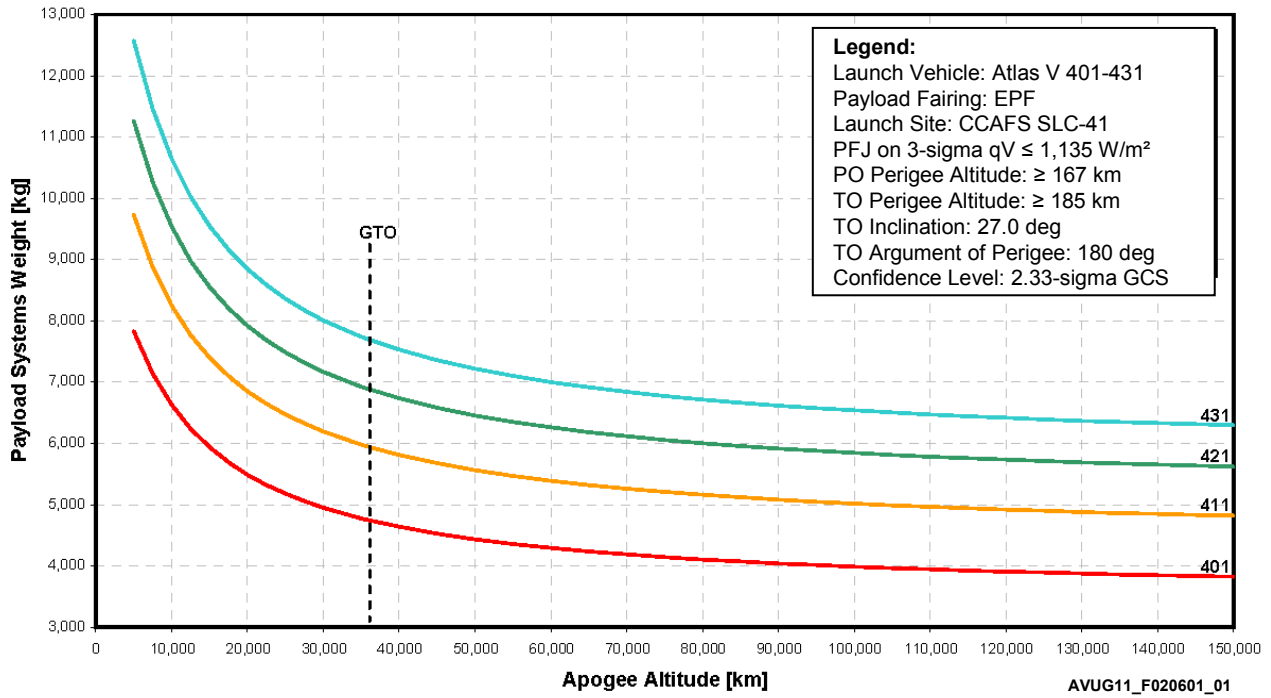


Table 2.6.1-1: Atlas V 401-431 Geo-transfer Orbit Performance — PSW vs Apogee Altitude (1 of 2)

Atlas V 401 GTO — PSW vs Apogee Altitude			
Apogee Altitude		Payload Systems Weight	
[km]	[nmi]	[kg]	[lb]
5,000	2,700	7,827	17,256
7,500	4,050	7,135	15,731
10,000	5,400	6,625	14,607
12,500	6,749	6,238	13,753
15,000	8,099	5,933	13,080
17,500	9,449	5,688	12,540
20,000	10,799	5,487	12,096
22,500	12,149	5,318	11,725
25,000	13,499	5,176	11,411
27,500	14,849	5,054	11,142
30,000	16,199	4,948	10,909
35,000	18,898	4,774	10,524
<b>35,786</b>	<b>19,323</b>	<b>4,750</b>	<b>10,470</b>
40,000	21,598	4,636	10,221
45,000	24,298	4,525	9,976
50,000	26,998	4,433	9,773
55,000	29,698	4,356	9,603
60,000	32,397	4,290	9,458
65,000	35,097	4,234	9,334
70,000	37,797	4,184	9,225
75,000	40,497	4,141	9,130
80,000	43,197	4,103	9,046
85,000	45,896	4,069	8,970
90,000	48,596	4,038	8,903
95,000	51,296	4,011	8,842
100,000	53,996	3,986	8,787
105,000	56,695	3,963	8,737
110,000	59,395	3,942	8,691
115,000	62,095	3,923	8,649
120,000	64,795	3,905	8,610
125,000	67,495	3,889	8,574
130,000	70,194	3,874	8,540
135,000	72,894	3,860	8,510
140,000	75,594	3,847	8,481
145,000	78,294	3,835	8,454
150,000	80,994	3,823	8,428

Notes:  
 Launch Site: CCAFS SLC-41  
 PLF Jettison at 3-sigma qV ≤ 1,135 W/m<sup>2</sup> (360 BTU/ft<sup>2</sup>-hr)  
 Park Orbit Perigee Altitude ≥ 167 km (90 nmi)  
 Transfer Orbit Perigee Altitude ≥ 185 km (100 nmi)  
 Transfer Orbit Inclination = 27.0 deg  
 Argument of Perigee = 180 deg  
 Confidence Level: 2.33 Sigma GCS  
 All parameters are at SC Separation except Apogee,  
 which is at 1st SC Apogee.  
 Only oblate Earth effects were taken into account when  
 propagating to 1st SC Apogee.

Atlas V 411 GTO — PSW vs Apogee Altitude			
Apogee Altitude		Payload Systems Weight	
[km]	[nmi]	[kg]	[lb]
5,000	2,700	9,729	21,448
7,500	4,050	8,869	19,552
10,000	5,400	8,242	18,170
12,500	6,749	7,766	17,121
15,000	8,099	7,394	16,301
17,500	9,449	7,095	15,642
20,000	10,799	6,847	15,096
22,500	12,149	6,642	14,644
25,000	13,499	6,468	14,260
27,500	14,849	6,321	13,935
30,000	16,199	6,191	13,649
35,000	18,898	5,978	13,180
<b>35,786</b>	<b>19,323</b>	<b>5,950</b>	<b>13,110</b>
40,000	21,598	5,810	12,809
45,000	24,298	5,674	12,509
50,000	26,998	5,562	12,261
55,000	29,698	5,467	12,054
60,000	32,397	5,387	11,877
65,000	35,097	5,318	11,724
70,000	37,797	5,258	11,592
75,000	40,497	5,205	11,475
80,000	43,197	5,158	11,372
85,000	45,896	5,117	11,280
90,000	48,596	5,079	11,198
95,000	51,296	5,046	11,124
100,000	53,996	5,015	11,056
105,000	56,695	4,987	10,995
110,000	59,395	4,962	10,939
115,000	62,095	4,939	10,888
120,000	64,795	4,917	10,840
125,000	67,495	4,897	10,796
130,000	70,194	4,879	10,756
135,000	72,894	4,862	10,718
140,000	75,594	4,846	10,683
145,000	78,294	4,831	10,650
150,000	80,994	4,817	10,619

Notes:  
 Launch Site: CCAFS SLC-41  
 PLF Jettison at 3-sigma qV ≤ 1,135 W/m<sup>2</sup> (360 BTU/ft<sup>2</sup>-hr)  
 Park Orbit Perigee Altitude ≥ 167 km (90 nmi)  
 Transfer Orbit Perigee Altitude ≥ 185 km (100 nmi)  
 Transfer Orbit Inclination = 27.0 deg  
 Argument of Perigee = 180 deg  
 Confidence Level: 2.33 Sigma GCS  
 All parameters are at SC Separation except Apogee,  
 which is at 1st SC Apogee.  
 Only oblate Earth effects were taken into account when  
 propagating to 1st SC Apogee.

Table 2.6.1-1: Atlas V 401-431 Geo-transfer Orbit Performance — PSW vs Apogee Altitude (2 of 2)

Atlas V 421 GTO — PSW vs Apogee Altitude			
Apogee Altitude		Payload Systems Weight	
[km]	[nmi]	[kg]	[lb]
5,000	2,700	11,263	24,832
7,500	4,050	10,260	22,619
10,000	5,400	9,529	21,009
12,500	6,749	8,977	19,792
15,000	8,099	8,545	18,838
17,500	9,449	8,199	18,075
20,000	10,799	7,915	17,450
22,500	12,149	7,680	16,932
25,000	13,499	7,481	16,493
27,500	14,849	7,311	16,118
30,000	16,199	7,164	15,794
35,000	18,898	6,922	15,261
<b>35,786</b>	<b>19,323</b>	<b>6,890</b>	<b>15,180</b>
40,000	21,598	6,732	14,842
45,000	24,298	6,579	14,503
50,000	26,998	6,452	14,224
55,000	29,698	6,348	13,996
60,000	32,397	6,258	13,797
65,000	35,097	6,181	13,626
70,000	37,797	6,113	13,477
75,000	40,497	6,054	13,346
80,000	43,197	6,001	13,231
85,000	45,896	5,955	13,128
90,000	48,596	5,913	13,036
95,000	51,296	5,875	12,952
100,000	53,996	5,841	12,877
105,000	56,695	5,810	12,808
110,000	59,395	5,781	12,745
115,000	62,095	5,755	12,688
120,000	64,795	5,731	12,635
125,000	67,495	5,709	12,586
130,000	70,194	5,688	12,540
135,000	72,894	5,669	12,498
140,000	75,594	5,651	12,459
145,000	78,294	5,634	12,422
150,000	80,994	5,619	12,387

**Notes:**  
 Launch Site: CCAFS SLC-41  
 PLF Jettison at 3-sigma qV ≤ 1,135 W/m<sup>2</sup> (360 BTU/ft<sup>2</sup>-hr)  
 Park Orbit Perigee Altitude ≥ 167 km (90 nmi)  
 Transfer Orbit Perigee Altitude ≥ 185 km (100 nmi)  
 Transfer Orbit Inclination = 27.0 deg  
 Argument of Perigee = 180 deg  
 Confidence Level: 2.33 Sigma GCS  
 All parameters are at SC Separation except Apogee, which is at 1st SC Apogee.  
 Only oblate Earth effects were taken into account when propagating to 1st SC Apogee.

Atlas V 431 GTO — PSW vs Apogee Altitude			
Apogee Altitude		Payload Systems Weight	
[km]	[nmi]	[kg]	[lb]
5,000	2,700	12,573	27,719
7,500	4,050	11,453	25,250
10,000	5,400	10,637	23,451
12,500	6,749	10,021	22,093
15,000	8,099	9,541	21,033
17,500	9,449	9,156	20,186
20,000	10,799	8,841	19,492
22,500	12,149	8,579	18,914
25,000	13,499	8,358	18,426
27,500	14,849	8,169	18,009
30,000	16,199	8,005	17,648
35,000	18,898	7,736	17,056
<b>35,786</b>	<b>19,323</b>	<b>7,700</b>	<b>16,970</b>
40,000	21,598	7,525	16,591
45,000	24,298	7,355	16,215
50,000	26,998	7,215	15,906
55,000	29,698	7,097	15,647
60,000	32,397	6,997	15,427
65,000	35,097	6,912	15,237
70,000	37,797	6,837	15,073
75,000	40,497	6,771	14,928
80,000	43,197	6,713	14,800
85,000	45,896	6,662	14,686
90,000	48,596	6,615	14,584
95,000	51,296	6,573	14,492
100,000	53,996	6,536	14,409
105,000	56,695	6,501	14,333
110,000	59,395	6,470	14,263
115,000	62,095	6,441	14,199
120,000	64,795	6,414	14,140
125,000	67,495	6,389	14,086
130,000	70,194	6,367	14,036
135,000	72,894	6,348	13,996
140,000	75,594	6,329	13,952
145,000	78,294	6,310	13,911
150,000	80,994	6,293	13,873

**Notes:**  
 Launch Site: CCAFS SLC-41  
 PLF Jettison at 3-sigma qV ≤ 1,135 W/m<sup>2</sup> (360 BTU/ft<sup>2</sup>-hr)  
 Park Orbit Perigee Altitude ≥ 167 km (90 nmi)  
 Transfer Orbit Perigee Altitude ≥ 185 km (100 nmi)  
 Transfer Orbit Inclination = 27.0 deg  
 Argument of Perigee = 180 deg  
 Confidence Level: 2.33 Sigma GCS  
 All parameters are at SC Separation except Apogee, which is at 1st SC Apogee.  
 Only oblate Earth effects were taken into account when propagating to 1st SC Apogee.

Figure 2.6.1-2: Atlas V 501-551 Apogee Variation Performance to Geo-transfer Orbit — CCAFS

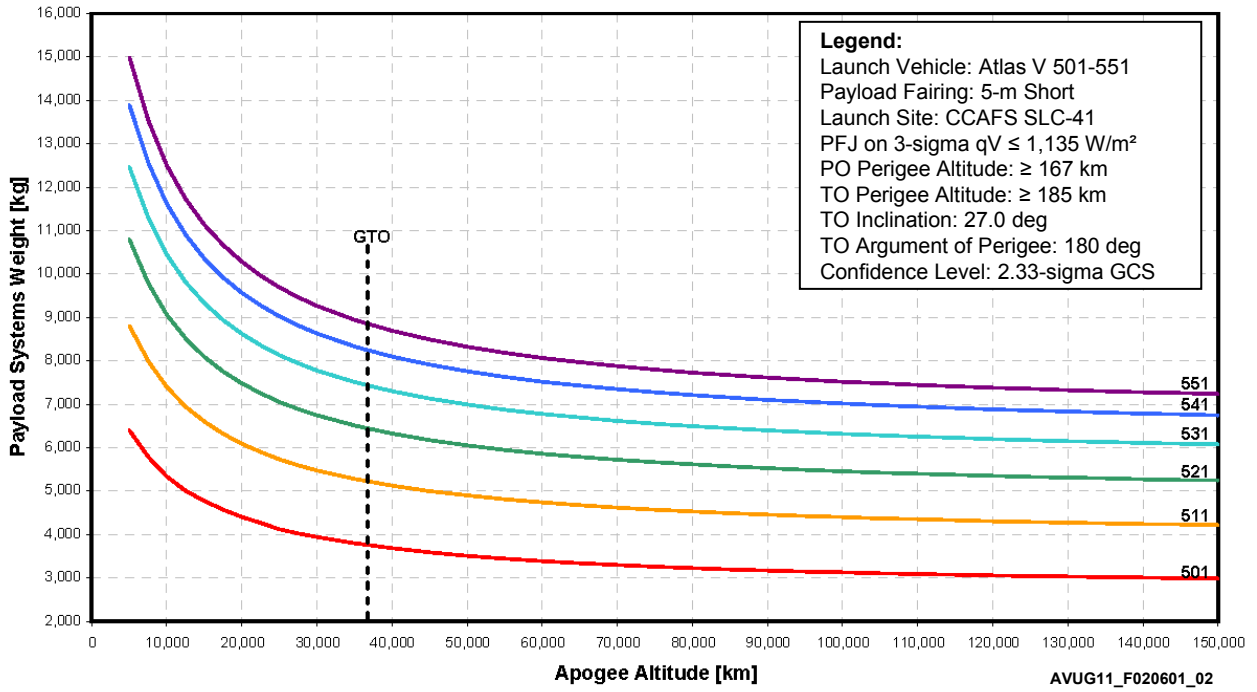


Table 2.6.1-2: Atlas V 501-551 Geo-transfer Orbit Performance — PSW vs Apogee Altitude (1 of 3)

Atlas V 501 GTO — PSW vs Apogee Altitude			
Apogee Altitude		Payload Systems Weight	
[km]	[nmi]	[kg]	[lb]
5,000	2,700	6,392	14,092
7,500	4,050	5,783	12,749
10,000	5,400	5,335	11,761
12,500	6,749	5,002	11,027
15,000	8,099	4,773	10,522
17,500	9,449	4,570	10,076
20,000	10,799	4,401	9,702
22,500	12,149	4,262	9,396
25,000	13,499	4,115	9,072
27,500	14,849	4,021	8,865
30,000	16,199	3,940	8,686
35,000	18,898	3,796	8,369
<b>35,786</b>	<b>19,323</b>	<b>3,775</b>	<b>8,320</b>
40,000	21,598	3,682	8,118
45,000	24,298	3,583	7,899
50,000	26,998	3,506	7,729
55,000	29,698	3,442	7,589
60,000	32,397	3,382	7,457
65,000	35,097	3,337	7,357
70,000	37,797	3,295	7,264
75,000	40,497	3,253	7,172
80,000	43,197	3,223	7,105
85,000	45,896	3,195	7,044
90,000	48,596	3,168	6,985
95,000	51,296	3,145	6,933
100,000	53,996	3,123	6,885
105,000	56,695	3,104	6,842
110,000	59,395	3,085	6,802
115,000	62,095	3,069	6,765
120,000	64,795	3,054	6,733
125,000	67,495	3,040	6,702
130,000	70,194	3,027	6,673
135,000	72,894	3,014	6,644
140,000	75,594	3,003	6,619
145,000	78,294	2,992	6,596
150,000	80,994	2,982	6,574

Notes:  
 Launch Site: CCAFS SLC-41  
 PLF Jettison at 3-sigma qV ≤ 1,135 W/m<sup>2</sup> (360 BTU/ft<sup>2</sup>-hr)  
 Park Orbit Perigee Altitude ≥ 167 km (90 nmi)  
 Transfer Orbit Perigee Altitude ≥ 185 km (100 nmi)  
 Transfer Orbit Inclination = 27.0 deg  
 Argument of Perigee = 180 deg  
 Confidence Level: 2.33 Sigma GCS  
 All parameters are at SC Separation except Apogee, which is at 1st SC Apogee.  
 Only oblate Earth effects were taken into account when propagating to 1<sup>st</sup> SC Apogee.

Atlas V 511 GTO — PSW vs Apogee Altitude			
Apogee Altitude		Payload Systems Weight	
[km]	[nmi]	[kg]	[lb]
5,000	2,700	8,807	19,416
7,500	4,050	7,988	17,611
10,000	5,400	7,394	16,301
12,500	6,749	6,944	15,310
15,000	8,099	6,594	14,536
17,500	9,449	6,313	13,918
20,000	10,799	6,083	13,411
22,500	12,149	5,893	12,991
25,000	13,499	5,731	12,635
27,500	14,849	5,593	12,331
30,000	16,199	5,473	12,066
35,000	18,898	5,277	11,634
<b>35,786</b>	<b>19,323</b>	<b>5,250</b>	<b>11,570</b>
40,000	21,598	5,123	11,294
45,000	24,298	4,998	11,018
50,000	26,998	4,895	10,791
55,000	29,698	4,809	10,601
60,000	32,397	4,735	10,439
65,000	35,097	4,672	10,300
70,000	37,797	4,617	10,179
75,000	40,497	4,569	10,072
80,000	43,197	4,526	9,978
85,000	45,896	4,488	9,894
90,000	48,596	4,454	9,819
95,000	51,296	4,423	9,752
100,000	53,996	4,395	9,690
105,000	56,695	4,370	9,634
110,000	59,395	4,347	9,583
115,000	62,095	4,326	9,536
120,000	64,795	4,306	9,493
125,000	67,495	4,288	9,453
130,000	70,194	4,271	9,416
135,000	72,894	4,255	9,382
140,000	75,594	4,241	9,350
145,000	78,294	4,227	9,320
150,000	80,994	4,215	9,292

Notes:  
 Launch Site: CCAFS SLC-41  
 PLF Jettison at 3-sigma qV ≤ 1,135 W/m<sup>2</sup> (360 BTU/ft<sup>2</sup>-hr)  
 Park Orbit Perigee Altitude ≥ 167 km (90 nmi)  
 Transfer Orbit Perigee Altitude ≥ 185 km (100 nmi)  
 Transfer Orbit Inclination = 27.0 deg  
 Argument of Perigee = 180 deg  
 Confidence Level: 2.33 Sigma GCS  
 All parameters are at SC Separation except Apogee, which is at 1st SC Apogee.  
 Only oblate Earth effects were taken into account when propagating to 1<sup>st</sup> SC Apogee.

Table 2.6.1-2: Atlas V 501-551 Geo-transfer Orbit Performance — PSW vs Apogee Altitude (2 of 3)

Atlas V 521 GTO — PSW vs Apogee Altitude			
Apogee Altitude		Payload Systems Weight	
[km]	[nmi]	[kg]	[lb]
5,000	2,700	10,790	23,789
7,500	4,050	9,785	21,571
10,000	5,400	9,058	19,970
12,500	6,749	8,512	18,766
15,000	8,099	8,088	17,830
17,500	9,449	7,749	17,083
20,000	10,799	7,475	16,480
22,500	12,149	7,245	15,973
25,000	13,499	7,051	15,545
27,500	14,849	6,885	15,180
30,000	16,199	6,742	14,863
35,000	18,898	6,507	14,345
<b>35,786</b>	<b>19,323</b>	<b>6,475</b>	<b>14,270</b>
40,000	21,598	6,322	13,938
45,000	24,298	6,173	13,609
50,000	26,998	6,050	13,338
55,000	29,698	5,947	13,111
60,000	32,397	5,860	12,918
65,000	35,097	5,784	12,752
70,000	37,797	5,719	12,608
75,000	40,497	5,662	12,482
80,000	43,197	5,611	12,370
85,000	45,896	5,566	12,270
90,000	48,596	5,525	12,180
95,000	51,296	5,489	12,100
100,000	53,996	5,456	12,027
105,000	56,695	5,425	11,961
110,000	59,395	5,398	11,900
115,000	62,095	5,373	11,844
120,000	64,795	5,349	11,793
125,000	67,495	5,328	11,746
130,000	70,194	5,308	11,702
135,000	72,894	5,289	11,661
140,000	75,594	5,272	11,623
145,000	78,294	5,256	11,587
150,000	80,994	5,241	11,554

Notes:  
 Launch Site: CCAFS SLC-41  
 PLF Jettison at 3-sigma qV ≤ 1,135 W/m<sup>2</sup> (360 BTU/ft<sup>2</sup>-hr)  
 Park Orbit Perigee Altitude ≥ 167 km (90 nmi)  
 Transfer Orbit Perigee Altitude ≥ 185 km (100 nmi)  
 Transfer Orbit Inclination = 27.0 deg  
 Argument of Perigee = 180 deg  
 Confidence Level: 2.33 Sigma GCS  
 All parameters are at SC Separation except Apogee,  
 which is at 1st SC Apogee.  
 Only oblate Earth effects were taken into account when  
 propagating to 1st SC Apogee.

Atlas V 531 GTO — PSW vs Apogee Altitude			
Apogee Altitude		Payload Systems Weight	
[km]	[nmi]	[kg]	[lb]
5,000	2,700	12,455	27,458
7,500	4,050	11,288	24,885
10,000	5,400	10,446	23,029
12,500	6,749	9,806	21,619
15,000	8,099	9,323	20,554
17,500	9,449	8,933	19,694
20,000	10,799	8,614	18,990
22,500	12,149	8,350	18,409
25,000	13,499	8,129	17,922
27,500	14,849	7,940	17,505
30,000	16,199	7,776	17,143
35,000	18,898	7,508	16,552
<b>35,786</b>	<b>19,323</b>	<b>7,475</b>	<b>16,470</b>
40,000	21,598	7,301	16,095
45,000	24,298	7,131	15,722
50,000	26,998	6,991	15,414
55,000	29,698	6,875	15,156
60,000	32,397	6,775	14,937
65,000	35,097	6,690	14,749
70,000	37,797	6,616	14,585
75,000	40,497	6,551	14,442
80,000	43,197	6,493	14,315
85,000	45,896	6,442	14,202
90,000	48,596	6,396	14,100
95,000	51,296	6,354	14,009
100,000	53,996	6,317	13,926
105,000	56,695	6,283	13,851
110,000	59,395	6,252	13,782
115,000	62,095	6,223	13,719
120,000	64,795	6,197	13,661
125,000	67,495	6,172	13,607
130,000	70,194	6,150	13,558
135,000	72,894	6,129	13,512
140,000	75,594	6,109	13,469
145,000	78,294	6,091	13,428
150,000	80,994	6,074	13,390

Notes:  
 Launch Site: CCAFS SLC-41  
 PLF Jettison at 3-sigma qV ≤ 1,135 W/m<sup>2</sup> (360 BTU/ft<sup>2</sup>-hr)  
 Park Orbit Perigee Altitude ≥ 167 km (90 nmi)  
 Transfer Orbit Perigee Altitude ≥ 185 km (100 nmi)  
 Transfer Orbit Inclination = 27.0 deg  
 Argument of Perigee = 180 deg  
 Confidence Level: 2.33 Sigma GCS  
 All parameters are at SC Separation except Apogee,  
 which is at 1st SC Apogee.  
 Only oblate Earth effects were taken into account when  
 propagating to 1st SC Apogee.

Table 2.6.1-2: Atlas V 501-551 Geo-transfer Orbit Performance — PSW vs Apogee Altitude (3 of 3)

Atlas V 541 GTO — PSW vs Apogee Altitude			
Apogee Altitude		Payload Systems Weight	
[km]	[nmi]	[kg]	[lb]
5,000	2,700	13,885	30,611
7,500	4,050	12,561	27,692
10,000	5,400	11,610	25,596
12,500	6,749	10,901	24,032
15,000	8,099	10,345	22,807
17,500	9,449	9,913	21,854
20,000	10,799	9,562	21,080
22,500	12,149	9,268	20,432
25,000	13,499	9,021	19,888
27,500	14,849	8,810	19,424
30,000	16,199	8,627	19,020
35,000	18,898	8,330	18,365
<b>35,786</b>	<b>19,323</b>	<b>8,290</b>	<b>18,270</b>
40,000	21,598	8,096	17,850
45,000	24,298	7,909	17,435
50,000	26,998	7,754	17,094
55,000	29,698	7,624	16,809
60,000	32,397	7,514	16,566
65,000	35,097	7,424	16,367
70,000	37,797	7,342	16,186
75,000	40,497	7,270	16,027
80,000	43,197	7,206	15,887
85,000	45,896	7,150	15,762
90,000	48,596	7,099	15,650
95,000	51,296	7,053	15,550
100,000	53,996	7,012	15,458
105,000	56,695	6,974	15,376
110,000	59,395	6,940	15,300
115,000	62,095	6,908	15,230
120,000	64,795	6,879	15,166
125,000	67,495	6,852	15,107
130,000	70,194	6,827	15,052
135,000	72,894	6,804	15,001
140,000	75,594	6,783	14,953
145,000	78,294	6,763	14,909
150,000	80,994	6,744	14,868

Notes:  
 Launch Site: CCAFS SLC-41  
 PLF Jettison at 3-sigma qV ≤ 1,135 W/m<sup>2</sup> (360 BTU/ft<sup>2</sup>-hr)  
 Park Orbit Perigee Altitude ≥ 167 km (90 nmi)  
 Transfer Orbit Perigee Altitude ≥ 185 km (100 nmi)  
 Transfer Orbit Inclination = 27.0 deg  
 Argument of Perigee = 180 deg  
 Confidence Level: 2.33 Sigma GCS  
 All parameters are at SC Separation except Apogee, which is at 1st SC Apogee.  
 Only oblate Earth effects were taken into account when propagating to 1st SC Apogee.

Atlas V 551 GTO — PSW vs Apogee Altitude			
Apogee Altitude		Payload Systems Weight	
[km]	[nmi]	[kg]	[lb]
5,000	2,700	14,988	33,042
7,500	4,050	13,534	29,837
10,000	5,400	12,497	27,551
12,500	6,749	11,726	25,852
15,000	8,099	11,131	24,540
17,500	9,449	10,659	23,499
20,000	10,799	10,275	22,652
22,500	12,149	9,955	21,947
25,000	13,499	9,690	21,363
27,500	14,849	9,461	20,857
30,000	16,199	9,265	20,427
35,000	18,898	8,944	19,717
<b>35,786</b>	<b>19,323</b>	<b>8,900</b>	<b>19,620</b>
40,000	21,598	8,691	19,160
45,000	24,298	8,488	18,714
50,000	26,998	8,322	18,346
55,000	29,698	8,181	18,036
60,000	32,397	8,064	17,777
65,000	35,097	7,962	17,553
70,000	37,797	7,873	17,357
75,000	40,497	7,796	17,187
80,000	43,197	7,727	17,035
85,000	45,896	7,666	16,900
90,000	48,596	7,611	16,780
95,000	51,296	7,562	16,672
100,000	53,996	7,517	16,573
105,000	56,695	7,481	16,493
110,000	59,395	7,444	16,411
115,000	62,095	7,410	16,336
120,000	64,795	7,379	16,267
125,000	67,495	7,350	16,204
130,000	70,194	7,323	16,145
135,000	72,894	7,298	16,089
140,000	75,594	7,275	16,038
145,000	78,294	7,253	15,991
150,000	80,994	7,233	15,946

Notes:  
 Launch Site: CCAFS SLC-41  
 PLF Jettison at 3-sigma qV ≤ 1,135 W/m<sup>2</sup> (360 BTU/ft<sup>2</sup>-hr)  
 Park Orbit Perigee Altitude ≥ 167 km (90 nmi)  
 Transfer Orbit Perigee Altitude ≥ 185 km (100 nmi)  
 Transfer Orbit Inclination = 27.0 deg  
 Argument of Perigee = 180 deg  
 Confidence Level: 2.33 Sigma GCS  
 All parameters are at SC Separation except Apogee, which is at 1st SC Apogee.  
 Only oblate Earth effects were taken into account when propagating to 1st SC Apogee.



Figure 2.6.2-1: Atlas V 401-431 Reduced Inclination Performance to Geo-Transfer Orbit — CCAFS

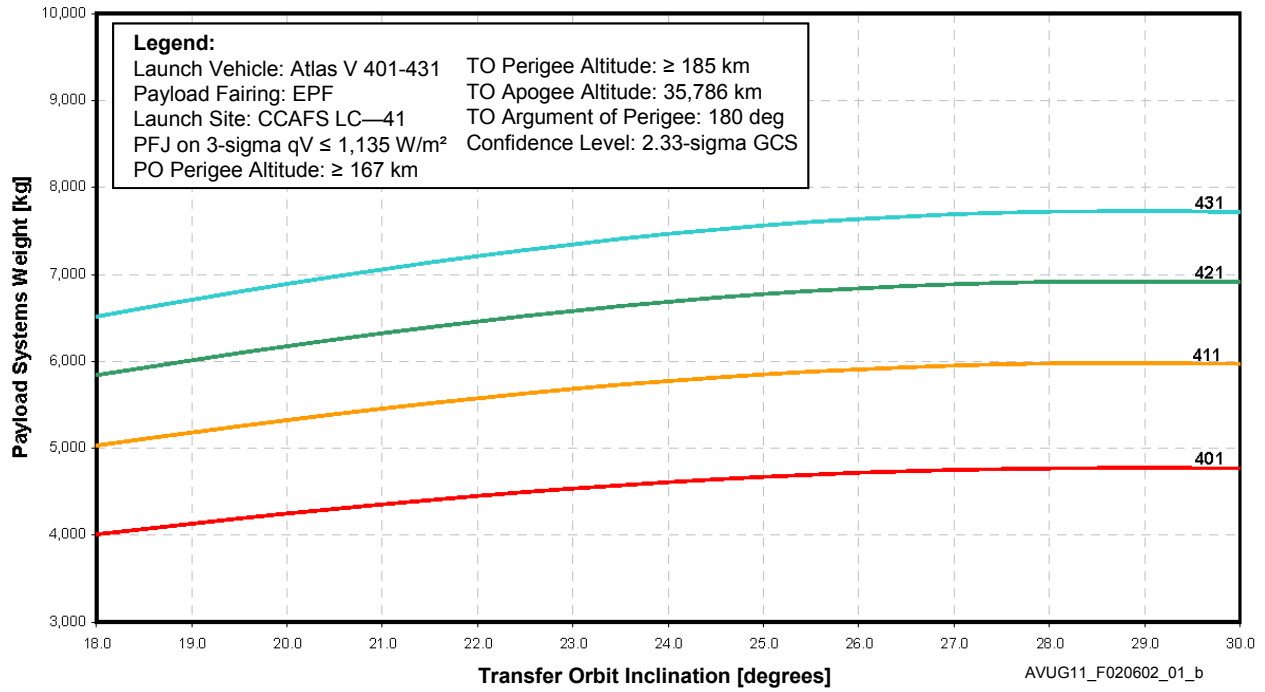


Table 2.6.2-1: Atlas V 401-431 Geo-transfer Orbit Performance — PSW vs Orbit Inclination (1 of 2)

Atlas V 401 GTO — PSW vs Inclination		
Inclination	Payload Systems Weight	
	[kg]	[lb]
30.0	4,769	10,514
29.5	4,772	10,520
29.0	4,773	10,523
28.5	4,771	10,518
28.0	4,767	10,509
27.5	4,760	10,494
<b>27.0</b>	<b>4,750</b>	<b>10,470</b>
26.5	4,735	10,438
26.0	4,716	10,398
25.5	4,694	10,349
25.0	4,668	10,291
24.5	4,640	10,229
24.0	4,608	10,159
23.5	4,573	10,081
23.0	4,535	9,997
22.5	4,493	9,906
22.0	4,449	9,809
21.5	4,403	9,706
21.0	4,353	9,597
20.5	4,301	9,483
20.0	4,247	9,363
19.5	4,190	9,238
19.0	4,132	9,109
18.5	4,071	8,975
18.0	4,009	8,838

**Notes:**  
 Launch Site: CCAFS SLC-41  
 PLF Jettison at 3-sigma  $qV \leq 1,135 \text{ W/m}^2$  (360 BTU/ft<sup>2</sup>-hr)  
 Park Orbit Perigee Altitude  $\geq 167 \text{ km}$  (90 nmi)  
 Transfer Orbit Perigee Altitude  $\geq 185 \text{ km}$  (100 nmi)  
 Transfer Orbit Apogee Altitude = 35,786 km (19,323 nmi)  
 Argument of Perigee = 180 deg  
 Confidence Level: 2.33 Sigma GCS  
 All parameters are at SC Separation except Apogee, which is at 1st SC Apogee.  
 Only oblate Earth effects were taken into account when propagating to 1st SC Apogee.

Atlas V 411 GTO — PSW vs Inclination		
Inclination	Payload Systems Weight	
	[kg]	[lb]
30.0	5,968	13,157
29.5	5,974	13,171
29.0	5,977	13,177
28.5	5,976	13,176
28.0	5,972	13,165
27.5	5,964	13,148
<b>27.0</b>	<b>5,950</b>	<b>13,110</b>
26.5	5,929	13,071
26.0	5,906	13,021
25.5	5,880	12,963
25.0	5,849	12,894
24.5	5,813	12,815
24.0	5,773	12,726
23.5	5,729	12,630
23.0	5,681	12,525
22.5	5,630	12,412
22.0	5,574	12,288
21.5	5,515	12,159
21.0	5,454	12,025
20.5	5,390	11,884
20.0	5,323	11,736
19.5	5,253	11,581
19.0	5,180	11,420
18.5	5,105	11,254
18.0	5,028	11,084

**Notes:**  
 Launch Site: CCAFS SLC-41  
 PLF Jettison at 3-sigma  $qV \leq 1,135 \text{ W/m}^2$  (360 BTU/ft<sup>2</sup>-hr)  
 Park Orbit Perigee Altitude  $\geq 167 \text{ km}$  (90 nmi)  
 Transfer Orbit Perigee Altitude  $\geq 185 \text{ km}$  (100 nmi)  
 Transfer Orbit Apogee Altitude = 35,786 km (19,323 nmi)  
 Argument of Perigee = 180 deg  
 Confidence Level: 2.33 Sigma GCS  
 All parameters are at SC Separation except Apogee, which is at 1st SC Apogee.  
 Only oblate Earth effects were taken into account when propagating to 1st SC Apogee.

Table 2.6.2-1: Atlas V 401-431 Geo-transfer Orbit Performance — PSW vs Orbit Inclination (2 of 2)

Atlas V 421 GTO — PSW vs Inclination		
Inclination	Payload Systems Weight	
	[kg]	[lb]
30.0	6,914	15,244
29.5	6,924	15,264
29.0	6,914	15,242
28.5	6,917	15,250
28.0	6,916	15,248
27.5	6,907	15,228
<b>27.0</b>	<b>6,890</b>	<b>15,180</b>
26.5	6,869	15,144
26.0	6,842	15,085
25.5	6,811	15,016
25.0	6,775	14,935
24.5	6,734	14,845
24.0	6,688	14,744
23.5	6,638	14,634
23.0	6,582	14,511
22.5	6,524	14,384
22.0	6,462	14,246
21.5	6,393	14,095
21.0	6,328	13,950
20.5	6,255	13,789
20.0	6,178	13,620
19.5	6,098	13,444
19.0	6,016	13,262
18.5	5,931	13,075
18.0	5,843	12,881

Notes:  
 Launch Site: CCAFS SLC-41  
 PLF Jettison at 3-sigma  $qV \leq 1,135 \text{ W/m}^2$  (360 BTU/ft<sup>2</sup>-hr)  
 Park Orbit Perigee Altitude  $\geq 167 \text{ km}$  (90 nmi)  
 Transfer Orbit Perigee Altitude  $\geq 185 \text{ km}$  (100 nmi)  
 Transfer Orbit Apogee Altitude = 35,786 km (19,323 nmi)  
 Argument of Perigee = 180 deg  
 Confidence Level: 2.33 Sigma GCS  
 All parameters are at SC Separation except Apogee, which is at 1st SC Apogee.  
 Only oblate Earth effects were taken into account when propagating to 1st SC Apogee.

Atlas V 431 GTO — PSW vs Inclination		
Inclination	Payload Systems Weight	
	[kg]	[lb]
30.0	7,723	17,027
29.5	7,735	17,053
29.0	7,739	17,061
28.5	7,734	17,050
28.0	7,731	17,045
27.5	7,719	17,017
<b>27.0</b>	<b>7,700</b>	<b>16,970</b>
26.5	7,676	16,922
26.0	7,647	16,858
25.5	7,612	16,781
25.0	7,571	16,691
24.5	7,525	16,589
24.0	7,474	16,476
23.5	7,417	16,352
23.0	7,356	16,217
22.5	7,291	16,073
22.0	7,221	15,918
21.5	7,146	15,755
21.0	7,067	15,581
20.5	6,986	15,401
20.0	6,900	15,211
19.5	6,810	15,014
19.0	6,718	14,811
18.5	6,623	14,601
18.0	6,525	14,384

Notes:  
 Launch Site: CCAFS SLC-41  
 PLF Jettison at 3-sigma  $qV \leq 1,135 \text{ W/m}^2$  (360 BTU/ft<sup>2</sup>-hr)  
 Park Orbit Perigee Altitude  $\geq 167 \text{ km}$  (90 nmi)  
 Transfer Orbit Perigee Altitude  $\geq 185 \text{ km}$  (100 nmi)  
 Transfer Orbit Apogee Altitude = 35,786 km (19,323 nmi)  
 Argument of Perigee = 180 deg  
 Confidence Level: 2.33 Sigma GCS  
 All parameters are at SC Separation except Apogee, which is at 1st SC Apogee.  
 Only oblate Earth effects were taken into account when propagating to 1st SC Apogee.

Figure 2.6.2-2: Atlas V 501-551 Reduced Inclination Performance to Geo-transfer Orbit — CCAFS

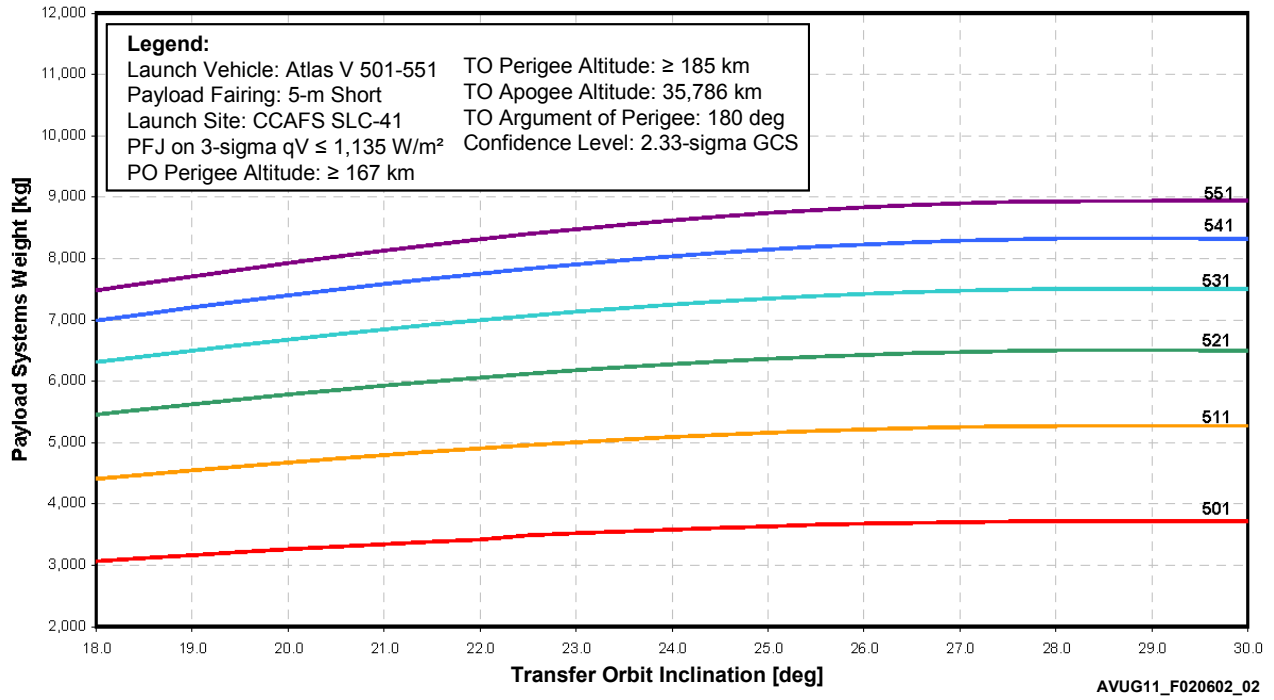


Table 2.6.2-2: Atlas V 501-551 Geo-transfer Orbit Performance — PSW vs Orbit Inclination (1 of 3)

Atlas V 501 GTO — PSW vs Inclination		
Inclination	Payload Systems Weight	
	[kg]	[lb]
30.0	3,793	8,361
29.5	3,796	8,369
29.0	3,795	8,366
28.5	3,794	8,365
28.0	3,791	8,358
27.5	3,784	8,343
<b>27.0</b>	<b>3,775</b>	<b>8,320</b>
26.5	3,761	8,292
26.0	3,746	8,258
25.5	3,727	8,218
25.0	3,701	8,159
24.5	3,678	8,108
24.0	3,651	8,049
23.5	3,620	7,982
23.0	3,589	7,912
22.5	3,554	7,836
22.0	3,488	7,691
21.5	3,451	7,608
21.0	3,412	7,522
20.5	3,370	7,431
20.0	3,327	7,334
19.5	3,280	7,232
19.0	3,233	7,128
18.5	3,181	7,013
18.0	3,130	6,901

Notes:  
 Launch Site: CCAFS SLC-41  
 PLF Jettison at 3-sigma  $qV \leq 1,135 \text{ W/m}^2$  (360 BTU/ft<sup>2</sup>-hr)  
 Park Orbit Perigee Altitude  $\geq 167 \text{ km}$  (90 nmi)  
 Transfer Orbit Perigee Altitude  $\geq 185 \text{ km}$  (100 nmi)  
 Transfer Orbit Apogee Altitude = 35,786 km (19,323 nmi)  
 Argument of Perigee = 180 deg  
 Confidence Level: 2.33 Sigma GCS  
 All parameters are at SC Separation except Apogee, which is at 1st SC Apogee.  
 Only oblate Earth effects were taken into account when propagating to 1st SC Apogee.

Atlas V 511 GTO — PSW vs Inclination		
Inclination	Payload Systems Weight	
	[kg]	[lb]
30.0	5,275	11,628
29.5	5,277	11,634
29.0	5,278	11,636
28.5	5,276	11,632
28.0	5,272	11,622
27.5	5,263	11,603
<b>27.0</b>	<b>5,250</b>	<b>11,570</b>
26.5	5,233	11,536
26.0	5,211	11,489
25.5	5,187	11,434
25.0	5,157	11,370
24.5	5,124	11,297
24.0	5,088	11,217
23.5	5,048	11,128
23.0	5,004	11,032
22.5	4,957	10,929
22.0	4,907	10,818
21.5	4,854	10,700
21.0	4,797	10,576
20.5	4,738	10,446
20.0	4,676	10,310
19.5	4,612	10,168
19.0	4,546	10,021
18.5	4,477	9,870
18.0	4,406	9,713

Notes:  
 Launch Site: CCAFS SLC-41  
 PLF Jettison at 3-sigma  $qV \leq 1,135 \text{ W/m}^2$  (360 BTU/ft<sup>2</sup>-hr)  
 Park Orbit Perigee Altitude  $\geq 167 \text{ km}$  (90 nmi)  
 Transfer Orbit Perigee Altitude  $\geq 185 \text{ km}$  (100 nmi)  
 Transfer Orbit Apogee Altitude = 35,786 km (19,323 nmi)  
 Argument of Perigee = 180 deg  
 Confidence Level: 2.33 Sigma GCS  
 All parameters are at SC Separation except Apogee, which is at 1st SC Apogee.  
 Only oblate Earth effects were taken into account when propagating to 1st SC Apogee.

Table 2.6.2-2: Atlas V 501-551 Geo-transfer Orbit Performance — PSW vs Orbit Inclination (2 of 3)

Atlas V 521 GTO — PSW vs Inclination		
Inclination	Payload Systems Weight	
	[kg]	[lb]
30.0	6,498	14,326
29.5	6,505	14,341
29.0	6,508	14,347
28.5	6,507	14,346
28.0	6,501	14,333
27.5	6,491	14,310
<b>27.0</b>	<b>6,475</b>	<b>14,270</b>
26.5	6,454	14,229
26.0	6,428	14,172
25.5	6,398	14,104
25.0	6,363	14,027
24.5	6,323	13,939
24.0	6,278	13,842
23.5	6,230	13,734
23.0	6,177	13,618
22.5	6,120	13,492
22.0	6,060	13,359
21.5	5,995	13,217
21.0	5,927	13,067
20.5	5,856	12,911
20.0	5,782	12,747
19.5	5,705	12,578
19.0	5,625	12,402
18.5	5,543	12,221
18.0	5,457	12,031

Notes:  
 Launch Site: CCAFS SLC-41  
 PLF Jettison at 3-sigma  $qV \leq 1,135 \text{ W/m}^2$  (360 BTU/ft<sup>2</sup>-hr)  
 Park Orbit Perigee Altitude  $\geq 167 \text{ km}$  (90 nmi)  
 Transfer Orbit Perigee Altitude  $\geq 185 \text{ km}$  (100 nmi)  
 Transfer Orbit Apogee Altitude = 35,786 km (19,323 nmi)  
 Argument of Perigee = 180 deg  
 Confidence Level: 2.33 Sigma GCS  
 All parameters are at SC Separation except Apogee, which is at 1st SC Apogee.  
 Only oblate Earth effects were taken into account when propagating to 1st SC Apogee.

Atlas V 531 GTO — PSW vs Inclination		
Inclination	Payload Systems Weight	
	[kg]	[lb]
30.0	7,497	16,528
29.5	7,506	16,548
29.0	7,510	16,557
28.5	7,509	16,555
28.0	7,503	16,540
27.5	7,490	16,512
<b>27.0</b>	<b>7,475</b>	<b>16,470</b>
26.5	7,451	16,426
26.0	7,421	16,361
25.5	7,386	16,283
25.0	7,345	16,194
24.5	7,300	16,093
24.0	7,248	15,980
23.5	7,192	15,856
23.0	7,132	15,723
22.5	7,066	15,579
22.0	6,997	15,425
21.5	6,923	15,262
21.0	6,845	15,090
20.5	6,764	14,911
20.0	6,678	14,723
19.5	6,590	14,529
19.0	6,499	14,328
18.5	6,405	14,121
18.0	6,308	13,908

Notes:  
 Launch Site: CCAFS SLC-41  
 PLF Jettison at 3-sigma  $qV \leq 1,135 \text{ W/m}^2$  (360 BTU/ft<sup>2</sup>-hr)  
 Park Orbit Perigee Altitude  $\geq 167 \text{ km}$  (90 nmi)  
 Transfer Orbit Perigee Altitude  $\geq 185 \text{ km}$  (100 nmi)  
 Transfer Orbit Apogee Altitude = 35,786 km (19,323 nmi)  
 Argument of Perigee = 180 deg  
 Confidence Level: 2.33 Sigma GCS  
 All parameters are at SC Separation except Apogee, which is at 1st SC Apogee.  
 Only oblate Earth effects were taken into account when propagating to 1st SC Apogee.

Table 2.6.2-2: Atlas V 501-551 Geo-transfer Orbit Performance — PSW vs Orbit Inclination (3 of 3)

Atlas V 541 GTO — PSW vs Inclination		
Inclination	Payload Systems Weight	
	[kg]	[lb]
30.0	8,317	18,337
29.5	8,327	18,358
29.0	8,332	18,368
28.5	8,332	18,368
28.0	8,325	18,353
27.5	8,311	18,322
<b>27.0</b>	<b>8,290</b>	<b>18,270</b>
26.5	8,262	18,215
26.0	8,230	18,143
25.5	8,190	18,056
25.0	8,144	17,955
24.5	8,093	17,841
24.0	8,035	17,714
23.5	7,972	17,576
23.0	7,904	17,425
22.5	7,831	17,264
22.0	7,752	17,091
21.5	7,670	16,909
21.0	7,583	16,717
20.5	7,491	16,516
20.0	7,400	16,315
19.5	7,302	16,098
19.0	7,200	15,873
18.5	7,095	15,642
18.0	6,988	15,406

**Notes:**  
 Launch Site: CCAFS SLC-41  
 PLF Jettison at 3-sigma qV ≤ 1,135 W/m<sup>2</sup> (360 BTU/ft<sup>2</sup>-hr)  
 Park Orbit Perigee Altitude ≥ 167 km (90 nmi)  
 Transfer Orbit Perigee Altitude ≥ 185 km (100 nmi)  
 Transfer Orbit Apogee Altitude = 35,786 km (19,323 nmi)  
 Argument of Perigee = 180 deg  
 Confidence Level: 2.33 Sigma GCS  
 All parameters are at SC Separation except Apogee,  
 which is at 1st SC Apogee.  
 Only oblate Earth effects were taken into account when  
 propagating to 1st SC Apogee.

Atlas V 551 GTO — PSW vs Inclination		
Inclination	Payload Systems Weight	
	[kg]	[lb]
30.0	8,947	19,725
29.5	8,944	19,719
29.0	8,941	19,712
28.5	8,939	19,708
28.0	8,928	19,682
27.5	8,921	19,669
<b>27.0</b>	<b>8,900</b>	<b>19,620</b>
26.5	8,871	19,558
26.0	8,835	19,479
25.5	8,793	19,384
25.0	8,741	19,272
24.5	8,686	19,148
24.0	8,622	19,008
23.5	8,554	18,859
23.0	8,479	18,693
22.5	8,400	18,520
22.0	8,315	18,332
21.5	8,225	18,133
21.0	8,130	17,924
20.5	8,031	17,706
20.0	7,928	17,479
19.5	7,821	17,242
19.0	7,711	17,000
18.5	7,597	16,749
18.0	7,485	16,502

**Notes:**  
 Launch Site: CCAFS SLC-41  
 PLF Jettison at 3-sigma qV ≤ 1,135 W/m<sup>2</sup> (360 BTU/ft<sup>2</sup>-hr)  
 Park Orbit Perigee Altitude ≥ 167 km (90 nmi)  
 Transfer Orbit Perigee Altitude ≥ 185 km (100 nmi)  
 Transfer Orbit Apogee Altitude = 35,786 km (19,323 nmi)  
 Argument of Perigee = 180 deg  
 Confidence Level: 2.33 Sigma GCS  
 All parameters are at SC Separation except Apogee,  
 which is at 1st SC Apogee.  
 Only oblate Earth effects were taken into account when  
 propagating to 1st SC Apogee.

Figure 2.6.3-1: Atlas V 401-431 Minimum  $\Delta V$  to Geosynchronous Orbit

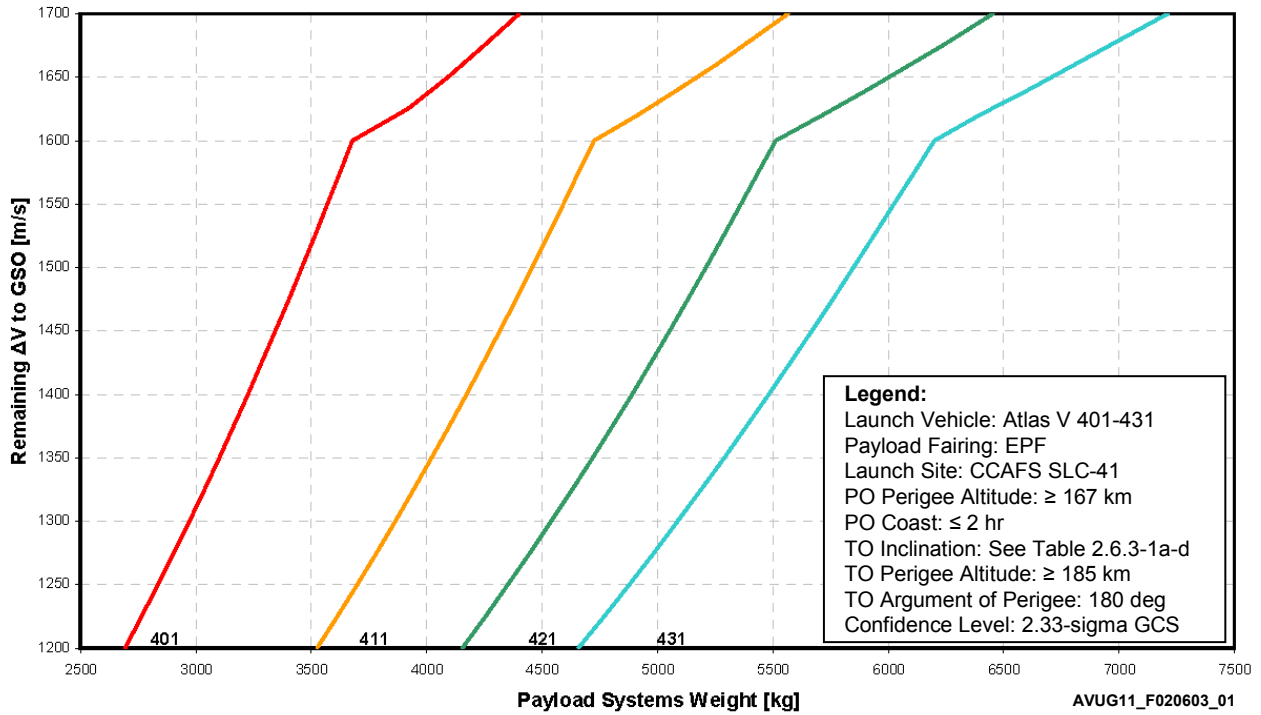


Figure 2.6.3-1a: Atlas V 401 Minimum  $\Delta V$  to Geosynchronous Orbit

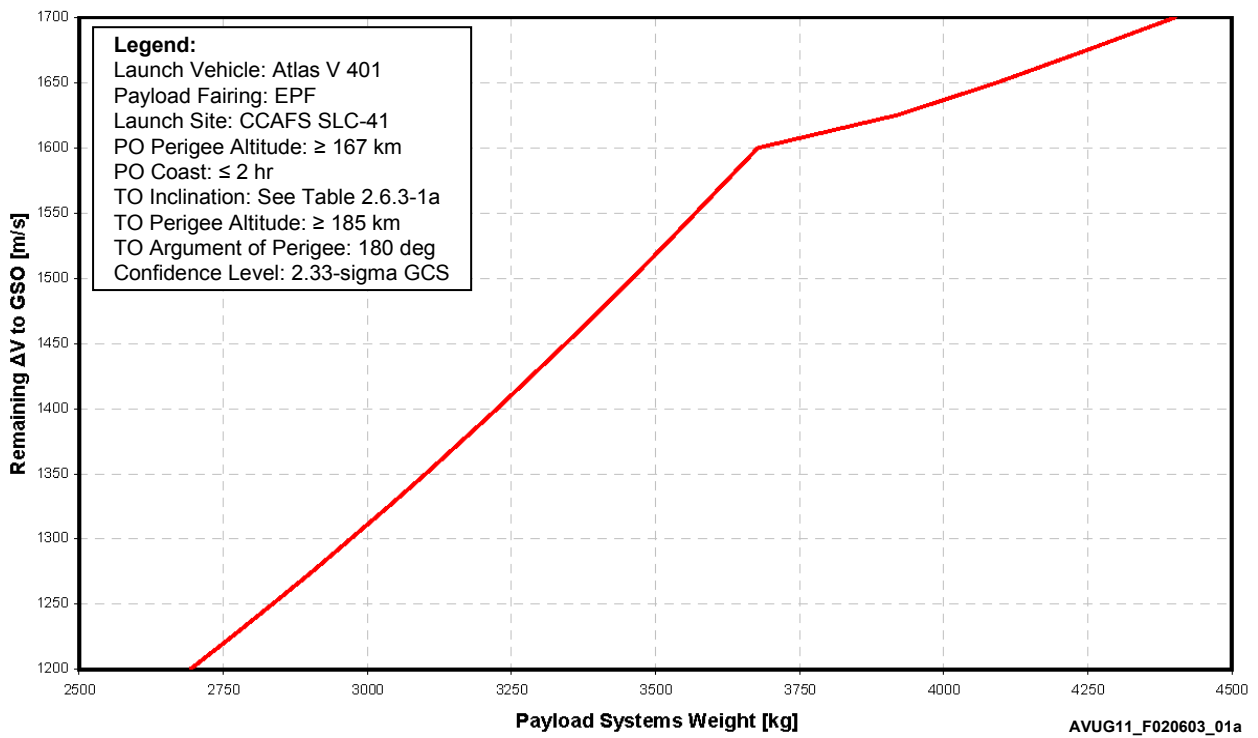




Table 2.6.3-1a: Atlas V 401 Minimum  $\Delta V$  to Geosynchronous Orbit — Apogee Cap

Atlas V 401 GTO — $\Delta V$ to GSO at 35,786 km (19,323 nmi)								
$\Delta V$ to GSO	Perigee		Inclination	True Anomaly	Payload Systems Weight		Longitude	Latitude
[m/s]	[km]	[nmi]	[deg]	[deg]	[kg]	[lb]	[deg]	[deg]
1,700	236	128	22.1	28.1	4,444	9,797	19.9	-10.3
1,675	242	131	20.8	28.2	4,249	9,368	20.3	-9.7
1,650	306	165	19.6	30.6	4,092	9,021	22.4	-9.9
1,625	520	281	19.2	37.7	3,919	8,639	28.1	-11.7
1,600	3,759	2,029	26.2	134.2	3,678	8,108	90.2	-18.6
1,575	4,074	2,200	25.8	133.6	3,624	7,989	90.3	-18.5
1,550	4,400	2,376	25.4	132.9	3,570	7,870	90.3	-18.4
1,525	4,694	2,534	24.9	131.7	3,515	7,750	90.6	-18.5
1,500	4,978	2,688	24.4	130.5	3,460	7,620	90.8	-18.4
1,475	5,306	2,865	24.0	129.2	3,402	7,501	90.8	-18.5
1,450	5,632	3,041	23.5	127.8	3,344	7,373	91.0	-18.5
1,425	5,947	3,211	23.1	126.4	3,285	7,243	91.1	-18.5
1,400	6,264	3,382	22.6	125.1	3,225	7,110	91.3	-18.5
1,375	6,582	3,554	22.2	123.6	3,164	6,975	91.5	-18.4
1,350	6,938	3,746	21.7	122.0	3,101	6,837	91.7	-18.4
1,325	7,254	3,917	21.3	120.6	3,037	6,695	91.9	-18.3
1,300	7,563	4,083	20.8	119.2	2,971	6,550	92.1	-18.2
1,275	7,896	4,264	20.3	117.6	2,904	6,402	92.3	-18.1
1,250	8,194	4,424	19.8	116.1	2,835	6,250	92.6	-17.9
1,225	8,498	4,588	19.3	114.5	2,765	6,095	92.8	-17.7
1,200	8,792	4,747	18.9	113.0	2,692	5,935	93.0	-17.4

**Notes:**  
 Launch Site: CCAFS SLC-41  
 Park Orbit Perigee Altitude  $\geq$  167 km (90 nmi)  
 Park Orbit Coast  $\leq$  2 Hours  
 Transfer Orbit Perigee Altitude  $\geq$  185 km (100 nmi)  
 Transfer Orbit Argument of Perigee = 180 deg  
 Confidence Level: 2.33 Sigma GCS  
 Apogee is at 1st SC Apogee, Perigee and Inclination are at SC Separation, True Anomaly is at Injection  
 Latitude and East Longitude are taken at SC Separation  
 Only oblate Earth effects were taken into account when propagating to 1st SC Apogee

Figure 2.6.3-1b: Atlas V 411 Minimum  $\Delta V$  to Geosynchronous Orbit

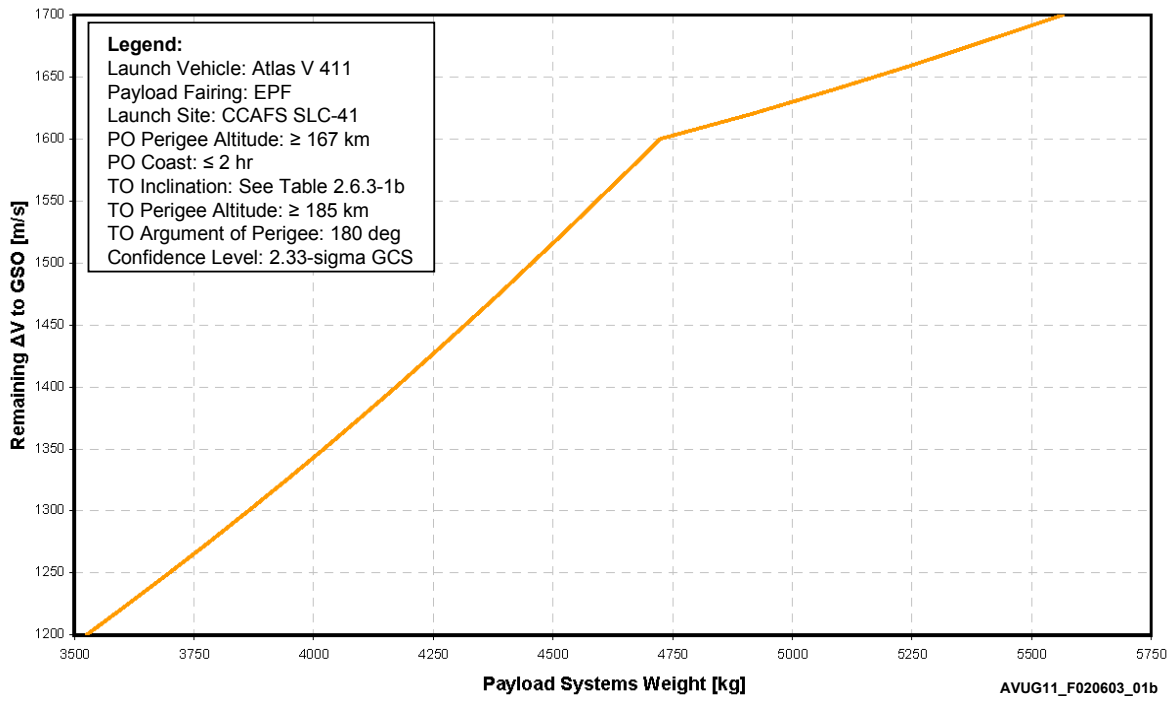


Table 2.6.3-1b: Atlas V 411 Minimum  $\Delta V$  to Geosynchronous Orbit — Apogee Cap

Atlas V 411 GTO — $\Delta V$ to GSO at 35,786 km (19,323 nmi)								
$\Delta V$ to GSO	Perigee		Inclination	True Anomaly	Payload Systems Weight		Longitude	Latitude
[m/s]	[km]	[nmi]	[deg]	[deg]	[kg]	[lb]	[deg]	[deg]
1,700	222	120	22.0	27.7	5,566	12,272	19.8	-10.1
1,660	248	134	20.0	29.3	5,255	11,586	21.5	-9.7
1,640	365	197	19.3	33.1	5,088	11,216	24.6	-10.5
1,620	625	338	19.4	41.0	4,915	10,835	31.1	-12.6
1,600	3,802	2,053	26.3	134.4	4,724	10,415	91.2	-18.6
1,575	4,085	2,206	25.8	134.2	4,658	10,270	91.3	-18.3
1,550	4,397	2,374	25.4	133.0	4,592	10,123	91.5	-18.4
1,525	4,703	2,540	24.9	131.8	4,525	9,975	91.6	-18.4
1,500	5,016	2,708	24.5	130.5	4,450	9,810	91.7	-18.5
1,475	5,341	2,884	24.0	129.2	4,387	9,672	91.8	-18.5
1,450	5,670	3,062	23.6	127.8	4,317	9,517	92.0	-18.5
1,425	6,006	3,243	23.1	126.4	4,245	9,359	92.1	-18.6
1,400	6,351	3,429	22.7	124.9	4,172	9,197	92.3	-18.6
1,375	6,638	3,584	22.2	123.6	4,097	9,033	92.5	-18.5
1,350	6,996	3,777	21.8	122.0	4,021	8,865	92.7	-18.5
1,325	7,314	3,949	21.3	120.5	3,943	8,694	92.9	-18.4
1,300	7,630	4,120	20.8	119.0	3,864	8,518	93.1	-18.2
1,275	7,976	4,307	20.4	117.4	3,782	8,338	93.3	-18.1
1,250	8,265	4,463	19.9	115.9	3,698	8,153	93.6	-17.9
1,225	8,573	4,629	19.4	114.3	3,612	7,964	93.9	-17.7
1,200	8,839	4,773	18.9	112.9	3,525	7,771	94.2	-17.5

**Notes:**  
 Launch Site: CCAFS SLC-41  
 Park Orbit Perigee Altitude  $\geq$  167 km (90 nmi)  
 Park Orbit Coast  $\leq$  2 Hours  
 Transfer Orbit Perigee Altitude  $\geq$  185 km (100 nmi)  
 Transfer Orbit Argument of Perigee = 180 deg  
 Confidence Level: 2.33 Sigma GCS  
 Apogee is at 1st SC Apogee, Perigee and Inclination are at SC Separation, True Anomaly is at Injection  
 Latitude and East Longitude are taken at SC Separation  
 Only oblate Earth effects were taken into account when propagating to 1st SC Apogee

Figure 2.6.3-1c: Atlas V 421 Minimum  $\Delta V$  to Geosynchronous Orbit

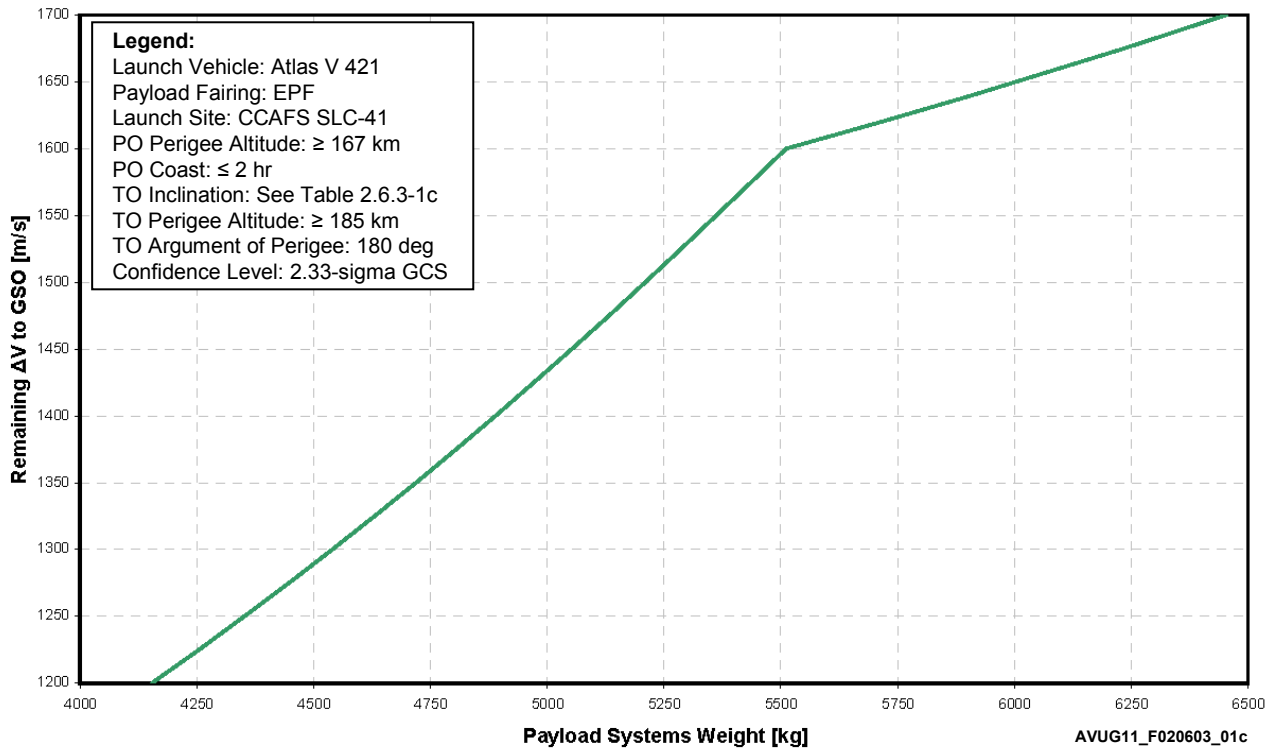


Table 2.6.3-1c: Atlas V 421 Minimum  $\Delta V$  to Geosynchronous Orbit — Apogee Cap

Atlas V 421 GTO — $\Delta V$ to GSO at 35,786 km (19,323 nmi)								
$\Delta V$ to GSO	Perigee		Inclination	True Anomaly	Payload Systems Weight		Longitude	Latitude
	[m/s]	[km]			[nmi]	[deg]		
1,700	218	118	22.0	28.3	6,454	14,228	20.5	-10.3
1,675	230	124	20.7	28.7	6,237	13,750	21.2	-9.9
1,640	382	206	19.4	34.0	5,910	13,028	25.4	-10.8
1,620	660	356	19.5	41.8	5,715	12,600	31.7	-13.0
1,600	3,827	2,066	26.3	134.2	5,511	12,151	91.5	-18.7
1,575	4,158	2,245	25.9	133.9	5,437	11,986	91.6	-18.5
1,550	4,461	2,409	25.5	133.0	5,362	11,822	91.6	-18.4
1,525	4,781	2,582	25.0	131.7	5,287	11,655	91.7	-18.5
1,500	5,105	2,757	24.6	130.4	5,210	11,480	91.8	-18.6
1,475	5,446	2,941	24.1	129.0	5,132	11,314	92.0	-18.7
1,450	5,781	3,122	23.7	127.6	5,053	11,139	92.1	-18.7
1,425	6,086	3,286	23.2	126.2	4,972	10,961	92.2	-18.7
1,400	6,429	3,471	22.8	124.7	4,889	10,779	92.3	-18.7
1,375	6,787	3,665	22.4	123.2	4,805	10,593	92.5	-18.7
1,350	7,133	3,851	21.9	121.6	4,719	10,403	92.7	-18.7
1,325	7,449	4,022	21.5	120.2	4,631	10,209	92.8	-18.6
1,300	7,782	4,202	21.0	118.5	4,540	10,009	93.1	-18.5
1,275	8,085	4,365	20.5	117.1	4,447	9,805	93.2	-18.3
1,250	8,404	4,538	20.0	115.6	4,352	9,595	93.4	-18.1
1,225	8,679	4,686	19.5	114.2	4,254	9,379	93.8	-17.9
1,200	8,974	4,845	19.0	112.8	4,154	9,157	94.0	-17.6

**Notes:**  
 Launch Site: CCAFS SLC-41  
 Park Orbit Perigee Altitude  $\geq$  167 km (90 nmi)  
 Park Orbit Coast  $\leq$  2 Hours  
 Transfer Orbit Perigee Altitude  $\geq$  185 km (100 nmi)  
 Transfer Orbit Argument of Perigee = 180 deg  
 Confidence Level: 2.33 Sigma GCS  
 Apogee is at 1st SC Apogee, Perigee and Inclination are at SC Separation, True Anomaly is at Injection  
 Latitude and East Longitude are taken at SC Separation  
 Only oblate Earth effects were taken into account when propagating to 1st SC Apogee

Figure 2.6.3-1d: Atlas V 431 Minimum  $\Delta V$  to Geosynchronous Orbit

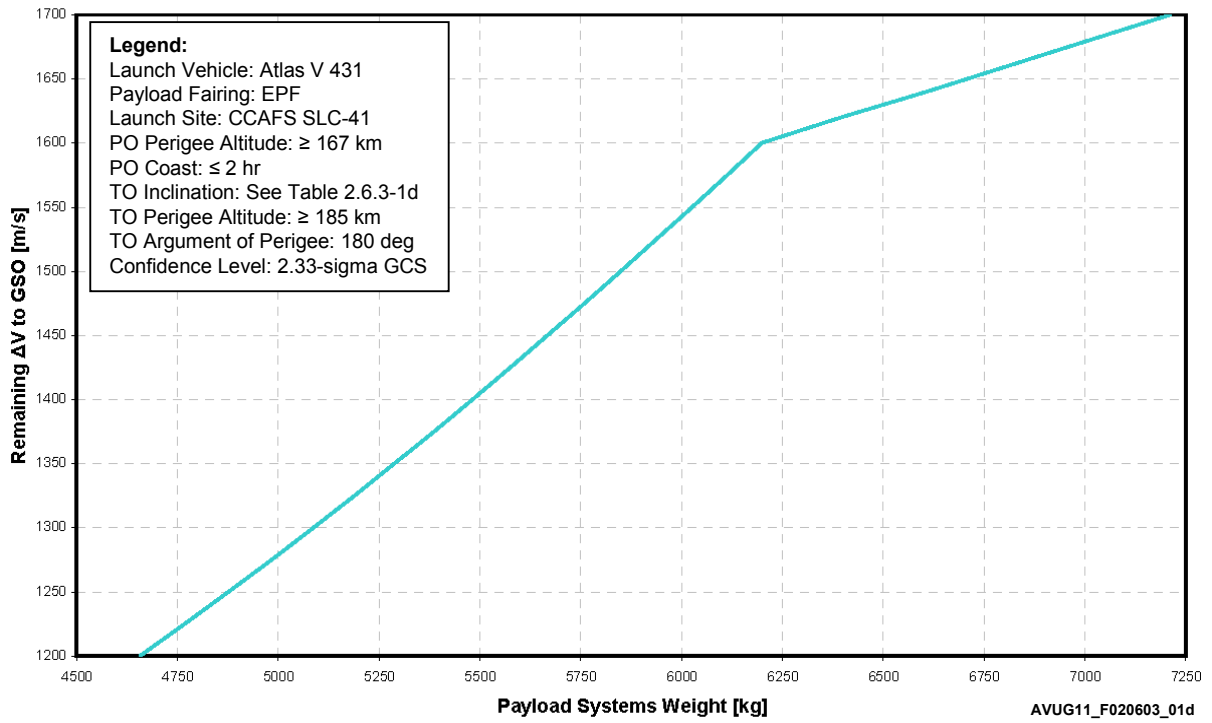


Table 2.6.3-1d: Atlas V 431 Minimum  $\Delta V$  to Geosynchronous Orbit — Apogee Cap

Atlas V 431 GTO — $\Delta V$ to GSO at 35,786 km (19,323 nmi)								
$\Delta V$ to GSO	Perigee		Inclination	True Anomaly	Payload Systems Weight		Longitude	Latitude
[m/s]	[km]	[nmi]	[deg]	[deg]	[kg]	[lb]	[deg]	[deg]
1,700	221	119	22.1	29.6	7,092	15,635	21.6	-10.8
1,675	237	128	20.7	30.2	6,885	15,178	22.3	-10.3
1,650	252	136	19.4	30.6	6,639	14,636	23.0	-9.8
1,625	355	192	18.4	31.3	6,366	14,034	23.8	-9.5
1,600	3,663	1,978	26.1	136.3	6,199	13,666	91.1	-17.8
1,575	3,991	2,155	25.7	135.1	6,113	13,476	91.2	-17.9
1,550	4,302	2,323	25.2	133.8	6,026	13,284	91.3	-18.0
1,525	4,641	2,506	24.8	132.5	5,938	13,090	91.2	-18.2
1,500	4,973	2,685	24.4	131.2	5,860	12,910	91.4	-18.2
1,475	5,310	2,867	24.0	129.8	5,759	12,696	91.4	-18.3
1,450	5,640	3,045	23.5	128.4	5,668	12,496	91.6	-18.4
1,425	5,993	3,236	23.1	126.9	5,575	12,292	91.7	-18.4
1,400	6,317	3,411	22.7	125.5	5,482	12,085	91.8	-18.4
1,375	6,660	3,596	22.2	124.0	5,386	11,874	91.9	-18.4
1,350	6,992	3,776	21.8	122.6	5,289	11,659	92.1	-18.3
1,325	7,338	3,962	21.3	121.0	5,189	11,440	92.2	-18.3
1,300	7,661	4,136	20.9	119.5	5,088	11,216	92.4	-18.2
1,275	7,985	4,311	20.4	118.0	4,984	10,987	92.6	-18.0
1,250	8,291	4,477	19.9	116.4	4,877	10,753	92.7	-17.9
1,225	8,610	4,649	19.5	115.0	4,769	10,513	93.1	-17.7
1,200	8,912	4,812	19.0	113.3	4,657	10,266	93.3	-17.5

**Notes:**  
 Launch Site: CCAFS SLC-41  
 Park Orbit Perigee Altitude  $\geq$  167 km (90 nmi)  
 Park Orbit Coast  $\leq$  2 Hours  
 Transfer Orbit Perigee Altitude  $\geq$  185 km (100 nmi)  
 Transfer Orbit Argument of Perigee = 180 deg  
 Confidence Level: 2.33 Sigma GCS  
 Apogee is at 1st SC Apogee, Perigee and Inclination are at SC Separation, True Anomaly is at Injection  
 Latitude and East Longitude are taken at SC Separation  
 Only oblate Earth effects were taken into account when propagating to 1st SC Apogee

Figure 2.6.3-2: Atlas V 501-551 Minimum  $\Delta V$  to Geosynchronous Orbit

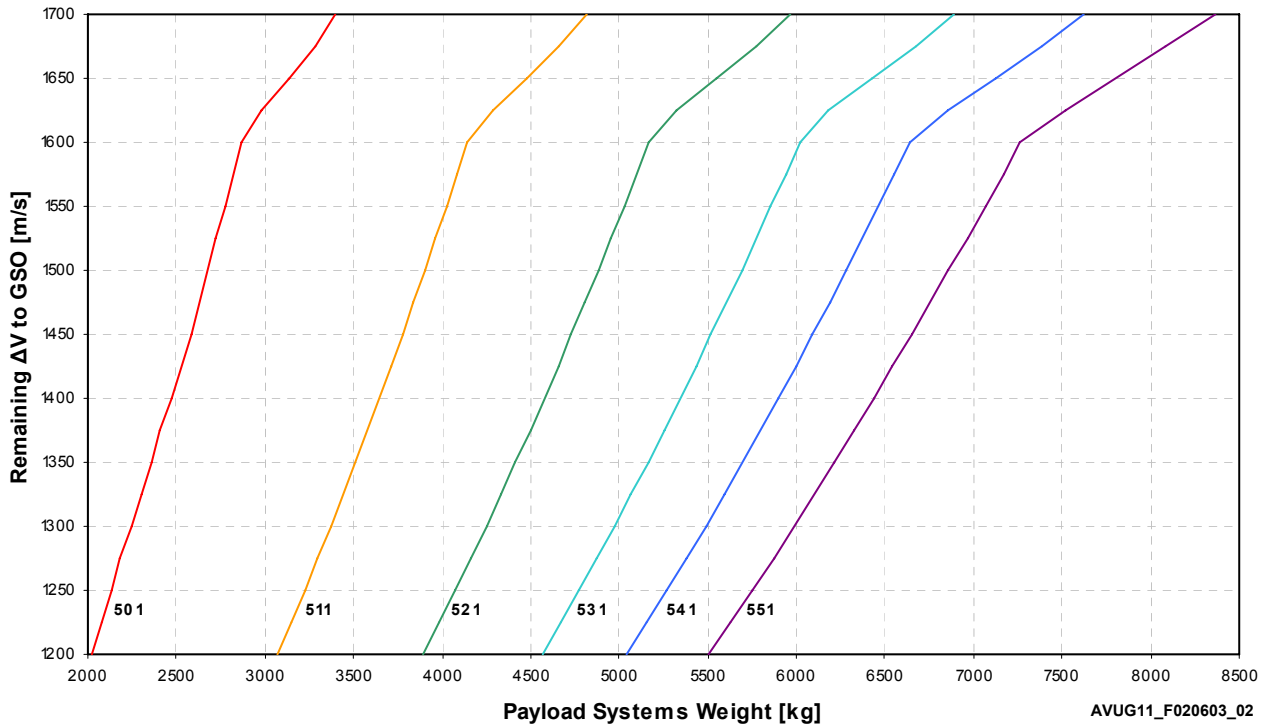


Figure 2.6.3-2a: Atlas V 501 Minimum  $\Delta V$  to Geosynchronous Orbit

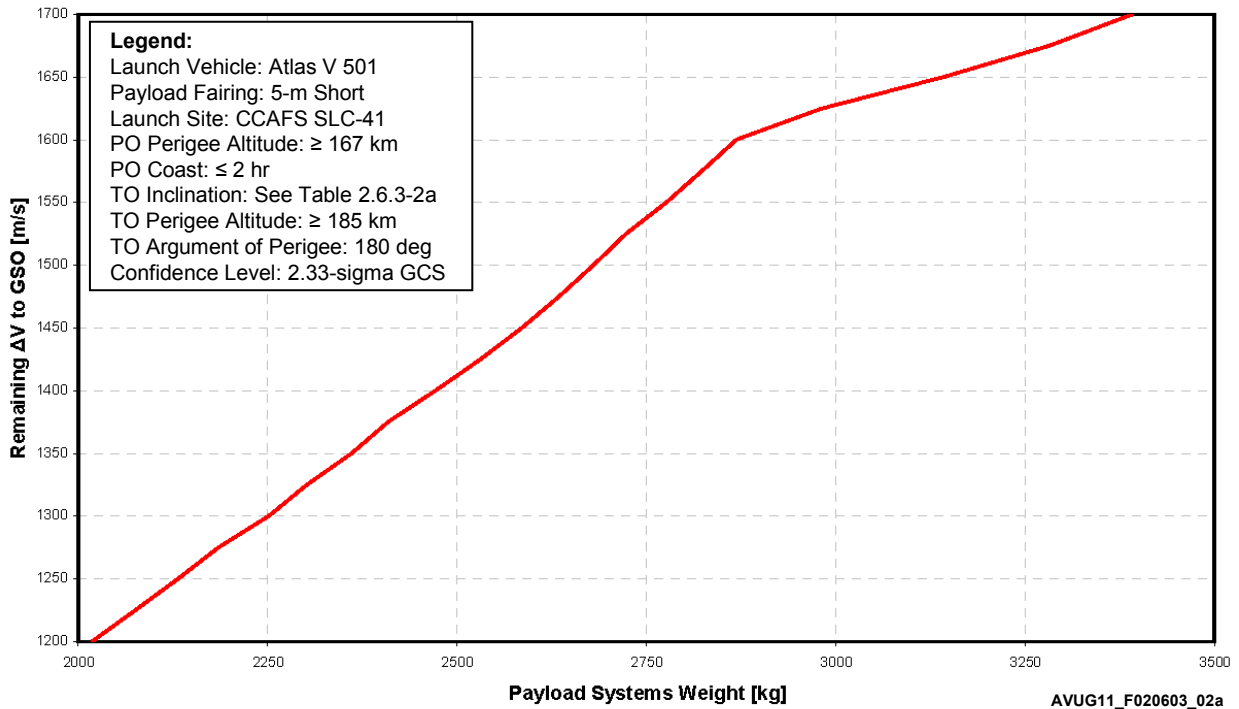




Table 2.6.3-2a: Atlas V 501 Minimum  $\Delta V$  to Geosynchronous Orbit — Apogee Cap

Atlas V 501 GTO — $\Delta V$ to GSO at 35,786 km (19,323 nmi)								
$\Delta V$ to GSO	Perigee		Inclination	True Anomaly	Payload Systems Weight		Longitude	Latitude
[m/s]	[km]	[nmi]	[deg]	[deg]	[kg]	[lb]	[deg]	[deg]
1,700	250	135	22.1	27.7	3,392	7,478	26.2	-10.2
1,675	277	149	20.9	28.7	3,282	7,236	28.3	-9.9
1,650	303	164	19.6	29.4	3,143	6,929	28.6	-9.6
1,625	370	200	18.5	31.1	2,982	6,573	31.5	-9.5
1,600	3,580	1,933	26.0	135.7	2,869	6,326	91.5	-17.9
1,575	3,840	2,073	25.5	134.6	2,823	6,224	91.7	-17.9
1,550	4,135	2,233	25.0	133.5	2,776	6,120	92.0	-18.0
1,525	4,547	2,455	24.7	131.7	2,723	6,003	91.9	-18.3
1,500	4,816	2,601	24.2	130.6	2,690	5,930	92.3	-18.3
1,475	5,086	2,746	23.7	129.5	2,635	5,808	92.5	-18.2
1,450	5,417	2,925	23.3	128.1	2,586	5,700	92.7	-18.2
1,425	5,744	3,101	22.8	126.6	2,531	5,580	92.4	-18.3
1,400	6,062	3,273	22.4	125.2	2,472	5,449	93.4	-18.3
1,375	6,307	3,406	21.8	124.1	2,409	5,312	93.5	-18.1
1,350	6,649	3,590	21.4	122.7	2,361	5,204	93.8	-18.0
1,325	6,953	3,754	20.9	121.2	2,302	5,074	93.3	-17.9
1,300	7,245	3,912	20.4	120.0	2,252	4,964	93.6	-17.7
1,275	7,560	4,082	20.0	118.1	2,185	4,818	94.6	-17.7
1,250	7,961	4,298	19.6	116.5	2,131	4,699	94.6	-17.6
1,225	8,246	4,452	19.1	115.1	2,075	4,575	94.8	-17.3
1,200	8,480	4,579	18.5	113.8	2,018	4,449	95.0	-17.0

**Notes:**  
 Launch Site: CCAFS SLC-41  
 Park Orbit Perigee Altitude  $\geq$  167 km (90 nmi)  
 Park Orbit Coast  $\leq$  2 Hours  
 Transfer Orbit Perigee Altitude  $\geq$  185 km (100 nmi)  
 Transfer Orbit Argument of Perigee = 180 deg  
 Confidence Level: 2.33 Sigma GCS  
 Apogee is at 1st SC Apogee, Perigee and Inclination are at SC Separation, True Anomaly is at Injection  
 Latitude and East Longitude are taken at SC Separation  
 Only oblate Earth effects were taken into account when propagating to 1st SC Apogee

Figure 2.6.3-2b: Atlas V 511 Minimum  $\Delta V$  to Geosynchronous Orbit

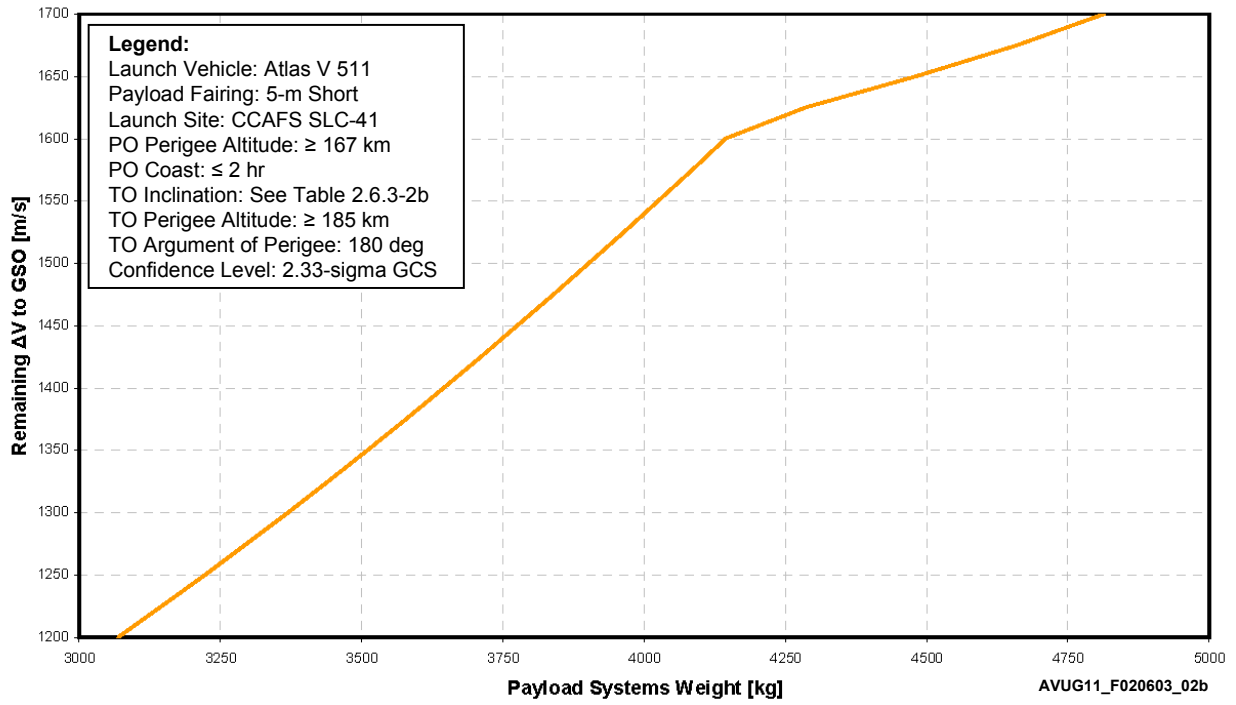


Table 2.6.3-2b: Atlas V 511 Minimum  $\Delta V$  to Geosynchronous Orbit — Apogee Cap

Atlas V 511 GTO — $\Delta V$ to GSO at 35,786 km (19,323 nmi)								
$\Delta V$ to GSO	Perigee		Inclination	True Anomaly	Payload Systems Weight		Longitude	Latitude
[m/s]	[km]	[nmi]	[deg]	[deg]	[kg]	[lb]	[deg]	[deg]
1,700	261	141	22.2	30.2	4,814	10,613	21.8	-11.0
1,675	294	159	21.0	31.5	4,660	10,274	23.2	-10.9
1,650	345	186	19.8	33.1	4,481	9,880	24.7	-10.8
1,625	484	261	19.0	34.0	4,286	9,449	25.9	-10.6
1,600	3,604	1,946	26.0	136.0	4,144	9,137	92.5	-17.9
1,575	3,889	2,100	25.6	134.8	4,085	9,006	92.5	-17.9
1,550	4,209	2,272	25.1	133.6	4,025	8,873	92.6	-18.0
1,525	4,512	2,436	24.7	132.3	3,964	8,739	92.9	-18.1
1,500	4,841	2,614	24.2	131.1	3,900	8,590	93.0	-18.1
1,475	5,147	2,779	23.8	129.7	3,839	8,464	93.2	-18.2
1,450	5,474	2,956	23.3	128.3	3,775	8,323	93.3	-18.2
1,425	5,782	3,122	22.9	127.0	3,711	8,181	93.6	-18.2
1,400	6,103	3,295	22.4	125.6	3,645	8,036	93.7	-18.2
1,375	6,440	3,477	22.0	124.2	3,578	7,889	93.9	-18.2
1,350	6,757	3,648	21.5	122.7	3,510	7,738	94.1	-18.1
1,325	7,085	3,825	21.1	121.2	3,441	7,585	94.2	-18.0
1,300	7,374	3,981	20.6	119.8	3,370	7,429	94.7	-17.9
1,275	7,713	4,165	20.1	118.2	3,297	7,268	94.8	-17.8
1,250	7,996	4,318	19.6	116.9	3,223	7,104	95.0	-17.6
1,225	8,291	4,477	19.2	115.2	3,147	6,938	95.3	-17.4
1,200	8,602	4,645	18.7	113.8	3,069	6,766	95.6	-17.1

**Notes:**  
 Launch Site: CCAFS SLC-41  
 Park Orbit Perigee Altitude  $\geq$  167 km (90 nmi)  
 Park Orbit Coast  $\leq$  2 Hours  
 Transfer Orbit Perigee Altitude  $\geq$  185 km (100 nmi)  
 Transfer Orbit Argument of Perigee = 180 deg  
 Confidence Level: 2.33 Sigma GCS  
 Apogee is at 1st SC Apogee, Perigee and Inclination are at SC Separation, True Anomaly is at Injection  
 Latitude and East Longitude are taken at SC Separation  
 Only oblate Earth effects were taken into account when propagating to 1st SC Apogee

Figure 2.6.3-2c: Atlas V 521 Minimum  $\Delta V$  to Geosynchronous Orbit

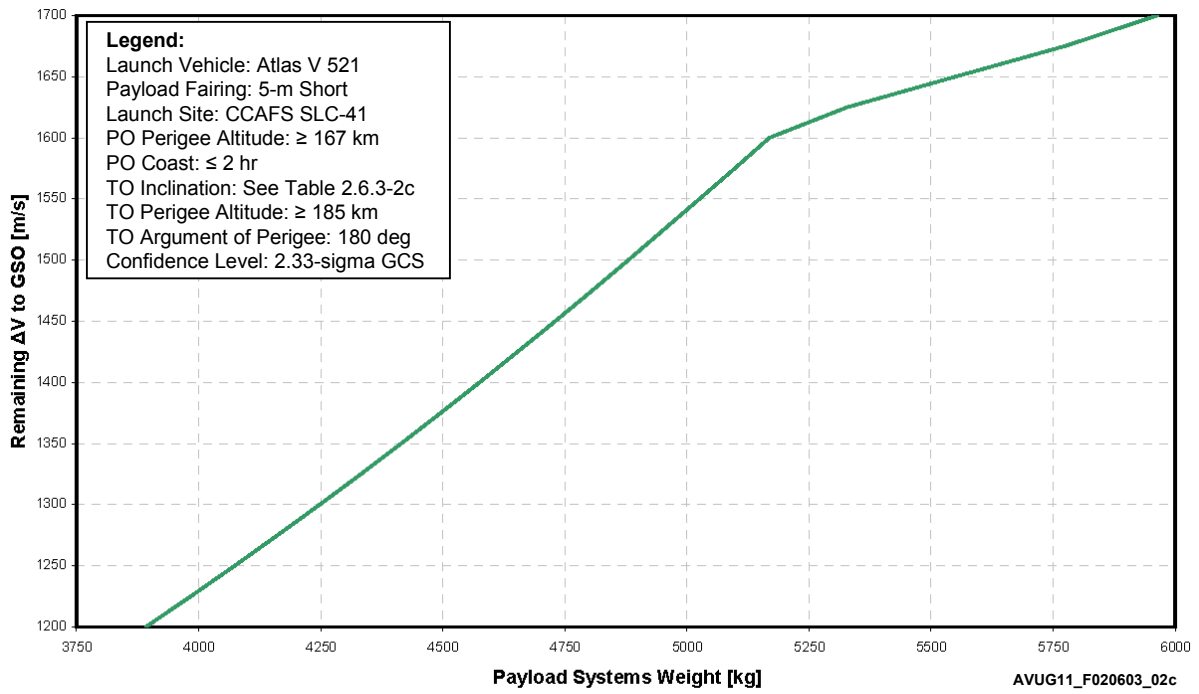


Table 2.6.3-2c: Atlas V 521 Minimum  $\Delta V$  to Geosynchronous Orbit — Apogee Cap

Atlas V 521 GTO — $\Delta V$ to GSO at 35,786 km (19,323 nmi)								
$\Delta V$ to GSO	Perigee		Inclination	True Anomaly	Payload Systems Weight		Longitude	Latitude
[m/s]	[km]	[nmi]	[deg]	[deg]	[kg]	[lb]	[deg]	[deg]
1,700	212	115	22.0	28.7	5,963	13,146	20.8	-10.4
1,675	238	129	20.7	29.8	5,775	12,731	22.0	-10.2
1,650	321	173	19.7	30.2	5,551	12,238	22.8	-9.8
1,625	452	244	18.9	31.1	5,328	11,746	23.9	-9.7
1,600	3,636	1,963	26.1	136.0	5,169	11,395	92.8	-17.9
1,575	3,897	2,104	25.6	135.0	5,098	11,238	93.1	-17.9
1,550	4,242	2,291	25.2	133.6	5,026	11,080	93.0	-18.0
1,525	4,555	2,459	24.7	132.4	4,953	10,921	93.2	-18.1
1,500	4,868	2,629	24.3	131.1	4,880	10,750	93.2	-18.2
1,475	5,206	2,811	23.9	129.8	4,806	10,595	93.3	-18.2
1,450	5,514	2,977	23.4	128.5	4,730	10,428	93.6	-18.2
1,425	5,857	3,163	23.0	127.0	4,654	10,259	93.7	-18.3
1,400	6,153	3,322	22.5	125.7	4,576	10,088	93.9	-18.2
1,375	6,511	3,516	22.1	124.2	4,496	9,912	94.0	-18.2
1,350	6,845	3,696	21.6	122.6	4,415	9,733	94.2	-18.2
1,325	7,166	3,869	21.2	121.2	4,333	9,552	94.4	-18.1
1,300	7,498	4,048	20.7	119.7	4,248	9,366	94.6	-18.0
1,275	7,814	4,219	20.2	118.2	4,162	9,175	94.6	-17.9
1,250	8,108	4,378	19.8	116.7	4,074	8,981	95.0	-17.7
1,225	8,379	4,524	19.2	115.3	3,984	8,783	95.3	-17.4
1,200	8,677	4,685	18.7	113.8	3,892	8,580	95.5	-17.2

Notes:  
 Launch Site: CCAFS SLC-41  
 Park Orbit Perigee Altitude  $\geq$  167 km (90 nmi)  
 Park Orbit Coast  $\leq$  2 Hours  
 Transfer Orbit Perigee Altitude  $\geq$  185 km (100 nmi)  
 Transfer Orbit Argument of Perigee = 180 deg  
 Confidence Level: 2.33 Sigma GCS  
 Apogee is at 1st SC Apogee, Perigee and Inclination are at SC Separation, True Anomaly is at Injection  
 Latitude and East Longitude are taken at SC Separation  
 Only oblate Earth effects were taken into account when propagating to 1st SC Apogee

Figure 2.6.3-2d: Atlas V 531 Minimum  $\Delta V$  to Geosynchronous Orbit

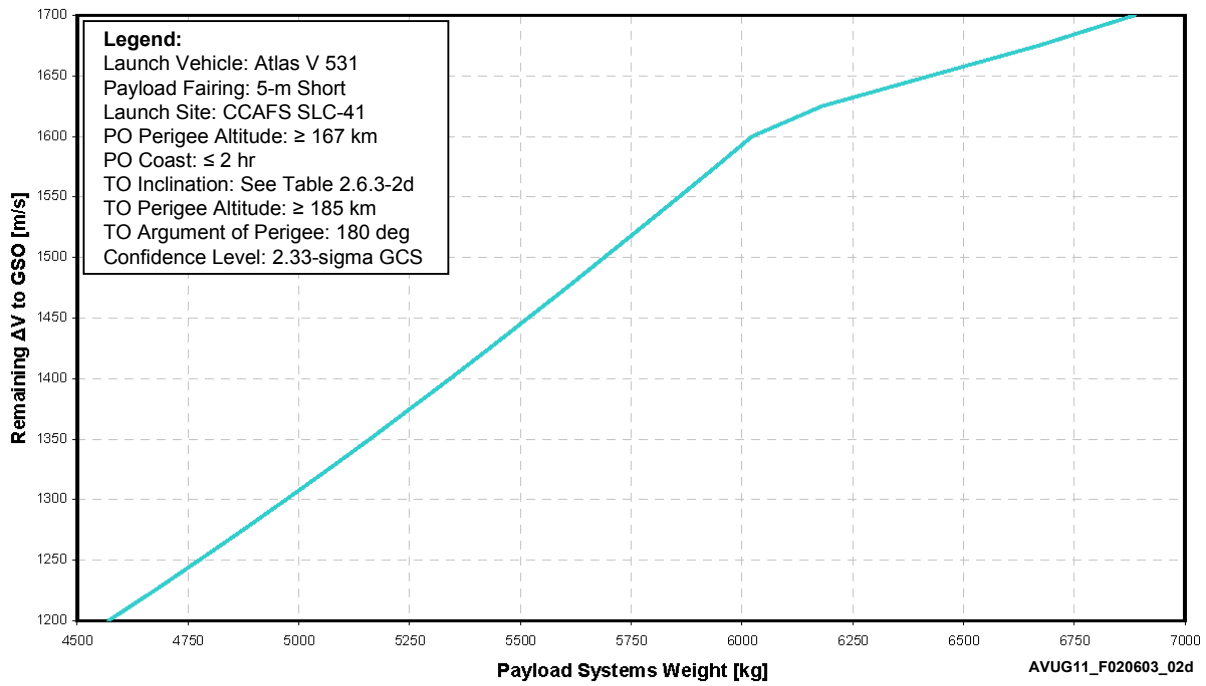


Table 2.6.3-2d: Atlas V 531 Minimum  $\Delta V$  to Geosynchronous Orbit — Apogee Cap

Atlas V 531 GTO — $\Delta V$ to GSO at 35,786 km (19,323 nmi)								
$\Delta V$ to GSO	Perigee		Inclination	True Anomaly	Payload Systems Weight		Longitude	Latitude
[m/s]	[km]	[nmi]	[deg]	[deg]	[kg]	[lb]	[deg]	[deg]
1,700	242	131	22.1	30.7	6,886	15,180	22.5	-11.2
1,675	267	144	20.9	31.4	6,671	14,706	23.4	-10.8
1,650	368	199	19.9	32.1	6,426	14,167	24.4	-10.5
1,625	531	287	19.2	32.5	6,180	13,626	25.1	-10.3
1,600	3,517	1,899	25.9	136.7	6,023	13,278	92.5	-17.5
1,575	3,821	2,063	25.5	135.5	5,941	13,097	92.6	-17.6
1,550	4,150	2,241	25.0	134.2	5,858	12,914	92.7	-17.8
1,525	4,458	2,407	24.6	133.0	5,774	12,730	92.8	-17.8
1,500	4,769	2,575	24.1	131.8	5,690	12,540	92.8	-17.9
1,475	5,102	2,755	23.7	130.4	5,604	12,355	93.0	-17.9
1,450	5,425	2,929	23.3	129.1	5,518	12,166	93.1	-18.0
1,425	5,746	3,103	22.8	127.8	5,430	11,972	93.3	-18.0
1,400	6,086	3,286	22.4	126.3	5,342	11,777	93.4	-18.0
1,375	6,401	3,456	22.0	124.9	5,252	11,578	93.5	-18.0
1,350	6,738	3,638	21.5	123.5	5,160	11,376	93.7	-17.9
1,325	7,080	3,823	21.1	122.0	5,067	11,170	93.9	-17.9
1,300	7,396	3,993	20.6	120.5	4,971	10,960	94.1	-17.8
1,275	7,715	4,166	20.1	119.0	4,875	10,747	94.2	-17.6
1,250	8,016	4,328	19.7	117.5	4,776	10,529	94.5	-17.5
1,225	8,324	4,494	19.2	116.1	4,675	10,306	94.6	-17.3
1,200	8,589	4,637	18.7	114.6	4,570	10,075	95.0	-17.0

Notes:  
 Launch Site: CCAFS SLC-41  
 Park Orbit Perigee Altitude  $\geq$  167 km (90 nmi)  
 Park Orbit Coast  $\leq$  2 Hours  
 Transfer Orbit Perigee Altitude  $\geq$  185 km (100 nmi)  
 Transfer Orbit Argument of Perigee = 180 deg  
 Confidence Level: 2.33 Sigma GCS  
 Apogee is at 1st SC Apogee, Perigee and Inclination are at SC Separation, True Anomaly is at Injection  
 Latitude and East Longitude are taken at SC Separation  
 Only oblate Earth effects were taken into account when propagating to 1st SC Apogee

Figure 2.6.3-2e: Atlas V 541 Minimum  $\Delta V$  to Geosynchronous Orbit

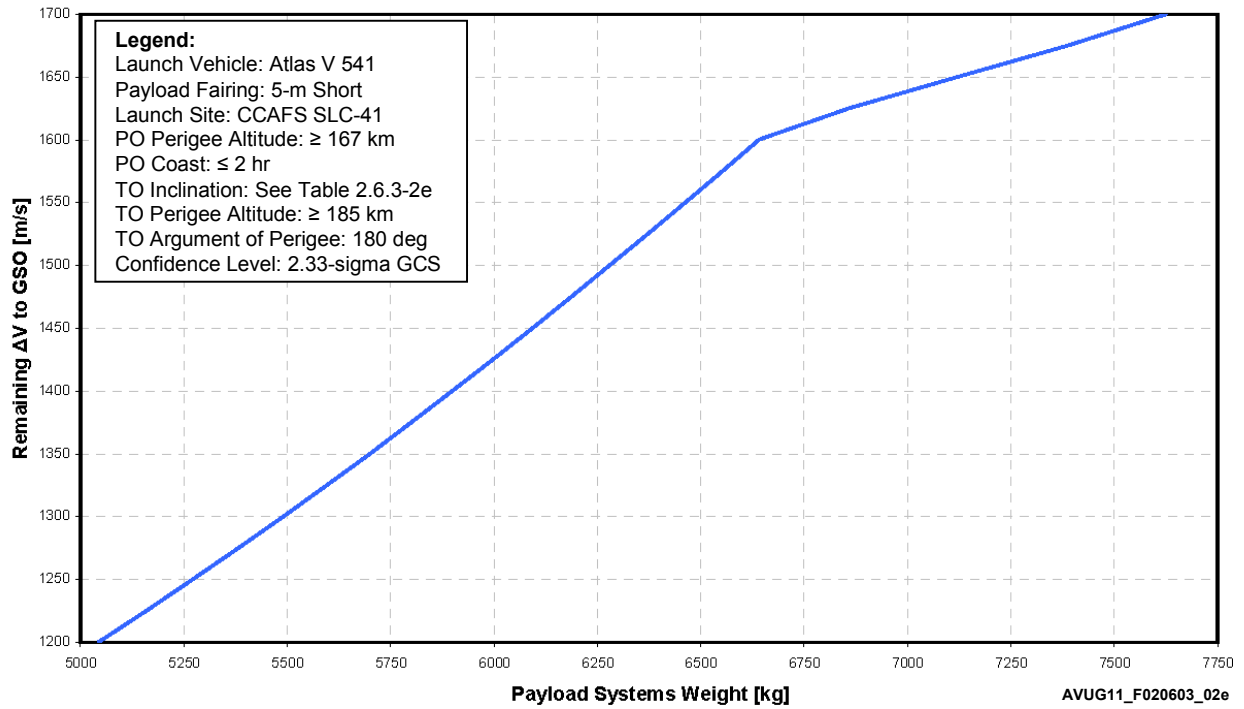




Table 2.6.3-2e: Atlas V 541 Minimum  $\Delta V$  to Geosynchronous Orbit — Apogee Cap

Atlas V 541 GTO — $\Delta V$ to GSO at 35,786 km (19,323 nmi)								
$\Delta V$ to GSO	Perigee		Inclination	True Anomaly	Payload Systems Weight		Longitude	Latitude
	[m/s]	[km]			[nmi]	[deg]		
1,700	229	124	22.1	31.0	7,624	16,809	22.8	-11.2
1,675	259	140	20.8	31.7	7,387	16,286	23.7	-10.8
1,650	407	220	20.1	32.2	7,121	15,700	24.7	-10.6
1,625	561	303	19.4	32.8	6,859	15,121	25.4	-10.4
1,600	3,706	2,001	26.2	135.7	6,641	14,641	92.8	-18.0
1,575	4,042	2,183	25.8	134.7	6,552	14,445	92.8	-18.1
1,550	4,347	2,347	25.3	133.6	6,462	14,247	92.9	-18.2
1,525	4,688	2,532	24.9	132.2	6,372	14,048	93.0	-18.3
1,500	4,982	2,690	24.4	131.0	6,280	13,840	93.0	-18.3
1,475	5,361	2,895	24.0	129.5	6,187	13,640	93.0	-18.4
1,450	5,664	3,058	23.6	128.2	6,093	13,432	93.3	-18.4
1,425	6,007	3,243	23.1	126.7	5,997	13,221	93.4	-18.5
1,400	6,357	3,433	22.7	125.3	5,899	13,006	93.4	-18.5
1,375	6,676	3,605	22.3	123.8	5,800	12,787	93.6	-18.5
1,350	7,005	3,782	21.8	122.4	5,699	12,565	93.8	-18.4
1,325	7,344	3,965	21.4	120.9	5,596	12,338	93.9	-18.3
1,300	7,654	4,133	20.9	119.4	5,490	12,104	94.1	-18.2
1,275	7,980	4,309	20.4	117.8	5,383	11,866	94.3	-18.1
1,250	8,267	4,464	19.9	116.5	5,272	11,622	94.5	-17.9
1,225	8,577	4,631	19.4	114.9	5,159	11,374	94.8	-17.7
1,200	8,818	4,761	18.9	113.7	5,043	11,118	95.0	-17.3

**Notes:**  
 Launch Site: CCAFS SLC-41  
 Park Orbit Perigee Altitude  $\geq$  167 km (90 nmi)  
 Park Orbit Coast  $\leq$  2 Hours  
 Transfer Orbit Perigee Altitude  $\geq$  185 km (100 nmi)  
 Transfer Orbit Argument of Perigee = 180 deg  
 Confidence Level: 2.33 Sigma GCS  
 Apogee is at 1st SC Apogee, Perigee and Inclination are at SC Separation, True Anomaly is at Injection  
 Latitude and East Longitude are taken at SC Separation  
 Only oblate Earth effects were taken into account when propagating to 1st SC Apogee

Figure 2.6.3-2f: Atlas V 551 Minimum  $\Delta V$  to Geosynchronous Orbit

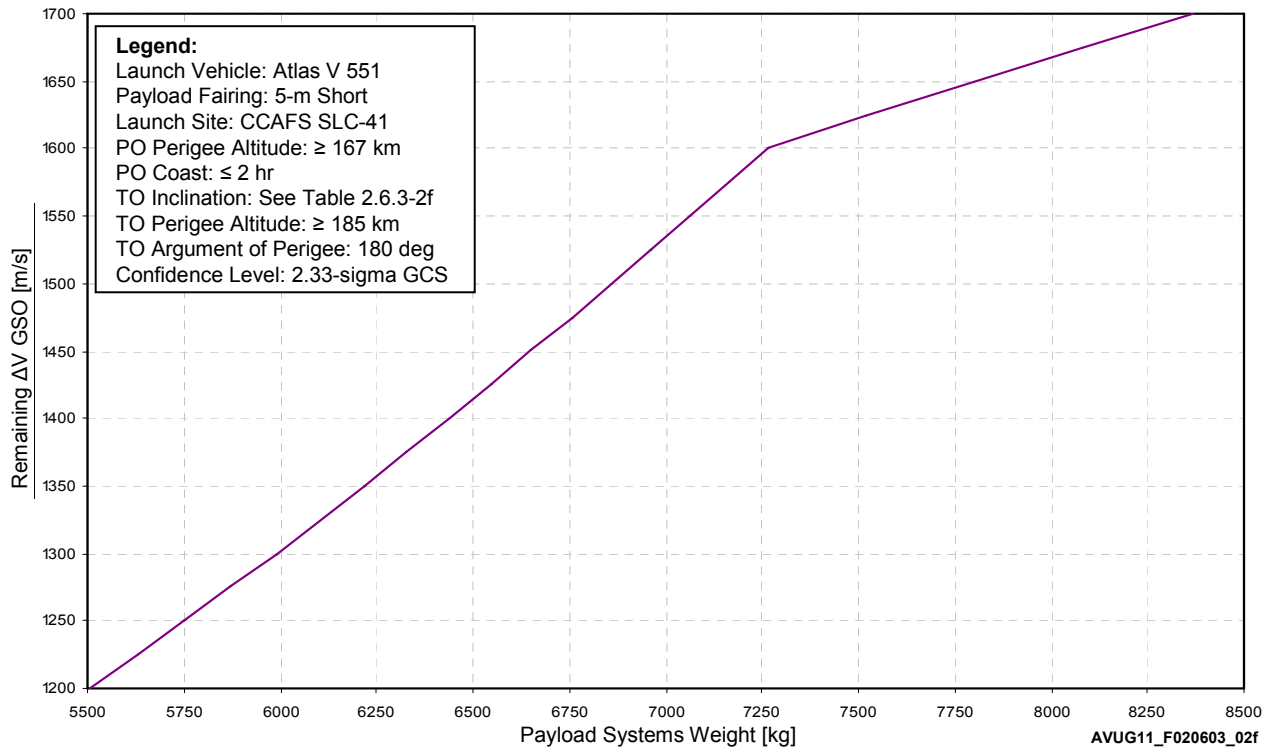


Table 2.6.3-2f: Atlas V 551 Minimum ΔV to Geosynchronous Orbit — Apogee Cap

Atlas V 551 GTO — ΔV to GSO at 35,786 km (19,323 nmi)								
ΔV to GSO	Perigee		Inclination	True Anomaly	Payload Systems Weight		Longitude	Latitude
[m/s]	[km]	[nmi]	[deg]	[deg]	[kg]	[lb]	[deg]	[deg]
1,700	206	111	22.0	30.3	8,366	18,445	22.3	-10.9
1,675	280	151	20.9	32.9	8,084	17,822	24.6	-11.3
1,650	433	234	20.2	33.5	7,798	17,193	25.6	-11.1
1,625	599	323	19.5	33.8	7,517	16,572	26.1	-10.8
1,600	3,532	1,907	25.9	136.9	7,266	16,020	92.3	-17.5
1,575	3,844	2,075	25.5	135.7	7,166	15,798	92.4	-17.6
1,550	4,167	2,250	25.1	134.5	7,065	15,575	92.5	-17.7
1,525	4,493	2,426	24.6	133.2	6,963	15,350	92.5	-17.8
1,500	4,824	2,605	24.2	131.9	6,860	15,120	92.6	-17.9
1,475	5,152	2,782	23.8	130.5	6,756	14,895	92.7	-18.0
1,450	5,477	2,958	23.4	129.2	6,652	14,665	92.8	-18.0
1,425	5,834	3,150	22.9	127.8	6,545	14,430	92.9	-18.1
1,400	6,171	3,332	22.5	126.3	6,438	14,193	93.0	-18.1
1,375	6,476	3,497	22.0	125.0	6,329	13,952	93.2	-18.0
1,350	6,892	3,721	21.7	123.1	6,217	13,707	93.3	-18.1
1,325	7,189	3,882	21.2	121.9	6,105	13,458	93.4	-18.0
1,300	7,499	4,049	20.7	120.4	5,990	13,205	93.6	-17.9
1,275	7,819	4,222	20.2	118.8	5,872	12,946	93.8	-17.8
1,250	8,105	4,376	19.7	117.4	5,752	12,682	94.0	-17.6
1,225	8,436	4,555	19.3	115.7	5,629	12,410	94.4	-17.4
1,200	8,716	4,706	18.8	114.5	5,505	12,137	94.4	-17.1

**Notes:**  
 Launch Site: CCAFS SLC-41  
 Park Orbit Perigee Altitude ≥ 167 km (90 nmi)  
 Park Orbit Coast ≤ 2 Hours  
 Transfer Orbit Perigee Altitude ≥ 185 km (100 nmi)  
 Transfer Orbit Argument of Perigee = 180 deg  
 Confidence Level: 2.33 Sigma GCS  
 Apogee is at 1st SC Apogee, Perigee and Inclination are at SC Separation, True Anomaly is at Injection  
 Latitude and East Longitude are taken at SC Separation  
 Only oblate Earth effects were taken into account when propagating to 1st SC Apogee

Figure 2.6.3-3: Atlas V 521-551 Minimum  $\Delta V$  to Geosynchronous Orbit (3 Burn)

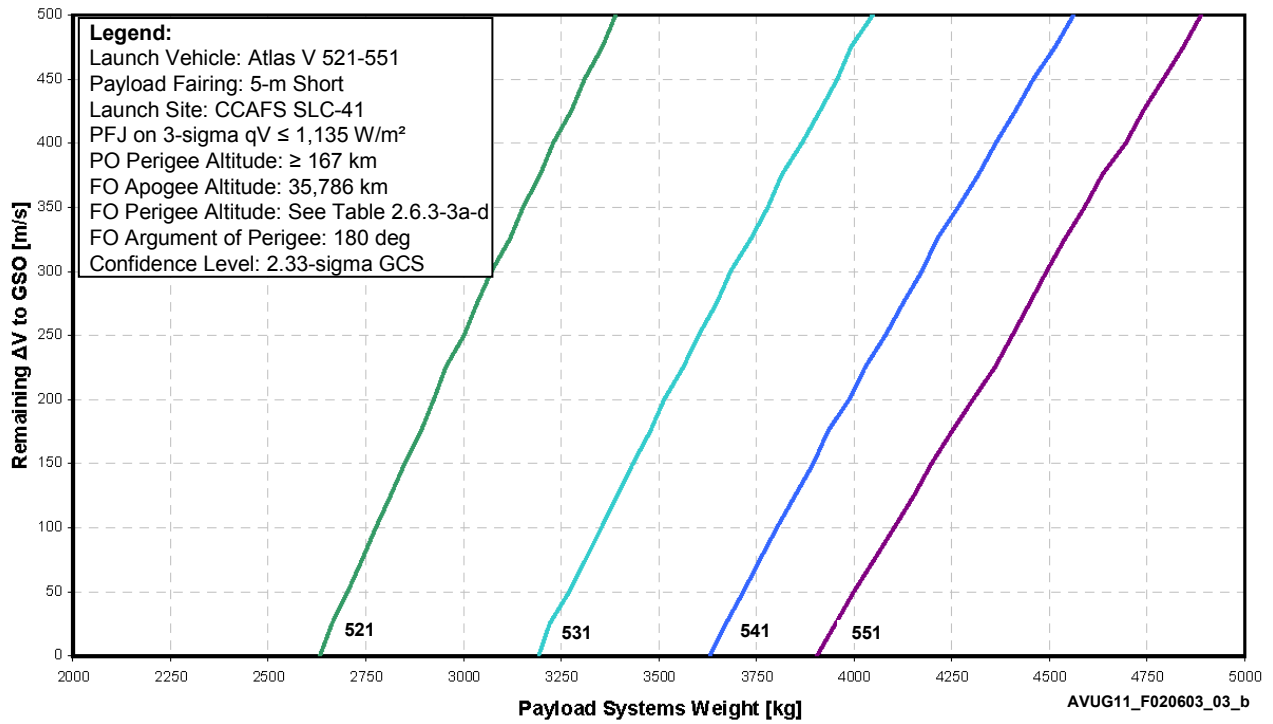


Figure 2.6.3-3a: Atlas V 521 Minimum  $\Delta V$  to Geosynchronous Orbit (3 Burn)

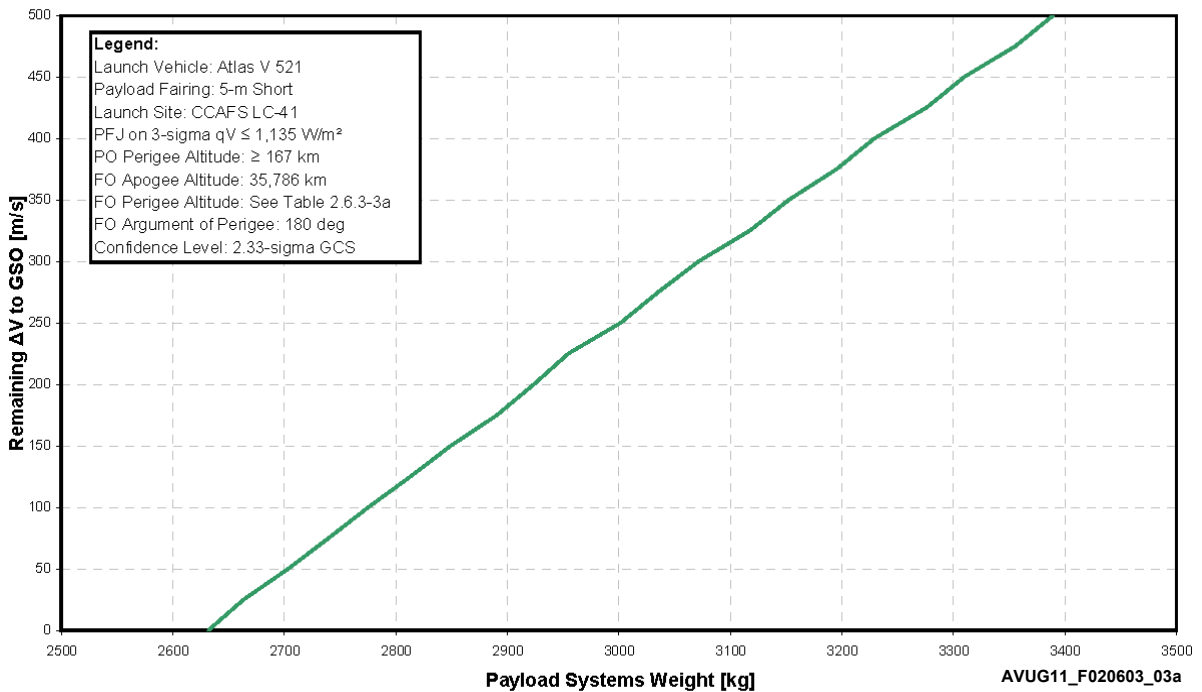


Table 2.6.3-3a: Atlas V 521 Minimum  $\Delta V$  to Geosynchronous Orbit (3 Burn) — Apogee Cap

Atlas V 521 GTO — $\Delta V$ to GSO at 35,786 km (19,323 nmi)								
$\Delta V$ to GSO	Perigee		Inclination	True Anomaly	Payload Systems Weight		Longitude	Latitude
	[m/s]	[km]			[nmi]	[deg]		
500	17,722	9,569	4.3	-178.7	3,389	7,472	95.2	0.1
475	18,403	9,937	4.1	-179.0	3,355	7,397	95.5	0.1
450	19,076	10,300	3.9	-179.2	3,310	7,297	95.2	0.1
425	19,752	10,665	3.6	-178.5	3,276	7,222	95.4	0.1
400	20,321	10,972	3.2	-176.6	3,229	7,118	95.4	0.2
375	21,147	11,418	3.1	-178.8	3,196	7,045	95.4	0.1
350	22,006	11,882	2.9	-178.7	3,152	6,950	95.2	0.1
325	22,735	12,276	2.7	-179.1	3,118	6,874	95.4	0.0
300	23,340	12,602	2.2	176.3	3,072	6,772	95.0	-0.1
275	24,198	13,066	2.0	179.9	3,035	6,691	95.4	0.0
250	25,251	13,635	2.0	-178.8	3,001	6,617	95.5	0.0
225	26,280	14,190	1.9	-179.3	2,955	6,514	95.4	0.0
200	27,079	14,621	1.6	-179.2	2,924	6,446	95.7	0.0
175	27,861	15,044	1.2	178.2	2,890	6,372	95.3	0.0
150	29,011	15,665	1.1	177.5	2,849	6,281	95.4	-0.1
125	30,068	16,235	1.0	-178.2	2,813	6,202	95.4	0.0
100	31,186	16,839	0.8	-179.3	2,775	6,118	95.5	0.0
75	32,242	17,409	0.6	-178.9	2,740	6,040	95.6	0.0
50	33,382	18,025	0.4	-179.2	2,703	5,960	95.6	0.0
25	34,678	18,725	0.3	175.4	2,663	5,871	95.4	0.0
0	35,786	19,323	0.0	Undefined	2,632	5,802	95.5	0.0

**Notes:**  
 Launch Site: CCAFS SLC-41  
 Park Orbit Perigee Altitude  $\geq$  167 km (90 nmi)  
 Park Orbit Coast  $\leq$  2 Hours  
 Transfer Orbit Perigee Altitude  $\geq$  185 km (100 nmi)  
 Transfer Orbit Argument of Perigee = 180 deg  
 Confidence Level: 2.33 Sigma GCS  
 Apogee is at 1st SC Apogee, Perigee and Inclination are at SC Separation, True Anomaly is at Injection  
 Latitude and East Longitude are taken at SC Separation  
 Only oblate Earth effects were taken into account when propagating to 1st SC Apogee

Figure 2.6.3-3b: Atlas V 531 Minimum  $\Delta V$  to Geosynchronous Orbit (3 Burn)

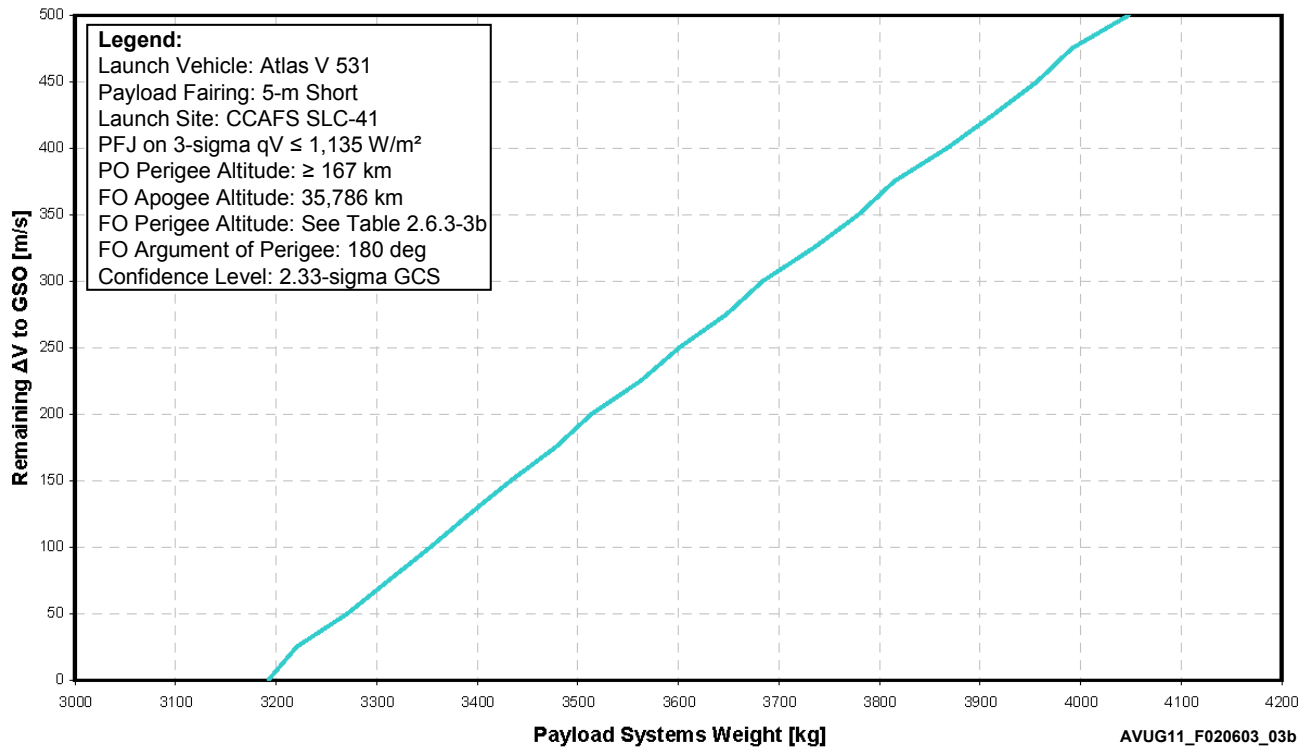


Table 2.6.3-3b: Atlas V 531 Minimum  $\Delta V$  to Geosynchronous Orbit (3 Burn) — Apogee Cap

Atlas V 531 GTO — $\Delta V$ to GSO at 35,786 km (19,323 nmi)								
$\Delta V$ to GSO	Perigee		Inclination	True Anomaly	Payload Systems Weight		Longitude	Latitude
[m/s]	[km]	[nmi]	[deg]	[deg]	[kg]	[lb]	[deg]	[deg]
500	17,772	9,596	4.4	-179.2	4,048	8,923	95.6	0.1
475	18,545	10,014	4.3	-179.4	3,991	8,799	95.2	0.0
450	19,073	10,299	3.8	-178.7	3,956	8,722	95.6	0.1
425	19,905	10,748	3.8	-178.7	3,913	8,626	95.3	0.1
400	20,466	11,051	3.4	-179.0	3,867	8,525	95.5	0.1
375	21,370	11,539	3.3	-179.5	3,815	8,410	95.1	0.0
350	21,977	11,867	2.9	-178.8	3,779	8,331	95.4	0.1
325	22,794	12,308	2.7	-179.2	3,735	8,234	95.5	0.0
300	23,510	12,694	2.4	-179.0	3,684	8,121	95.2	0.0
275	24,402	13,176	2.2	-178.9	3,648	8,042	95.4	0.0
250	25,171	13,591	1.9	-175.9	3,600	7,938	95.4	0.1
225	26,126	14,107	1.8	-178.5	3,562	7,854	95.4	0.0
200	26,974	14,565	1.5	-176.0	3,513	7,745	95.4	0.1
175	27,985	15,111	1.3	-178.0	3,478	7,667	95.5	0.0
150	29,041	15,681	1.2	-177.8	3,433	7,568	95.5	0.0
125	30,102	16,254	1.0	-178.4	3,392	7,479	95.4	0.0
100	31,089	16,787	0.7	179.7	3,354	7,393	95.4	0.0
75	32,252	17,415	0.6	-178.7	3,312	7,302	95.4	0.0
50	33,395	18,032	0.4	-178.9	3,271	7,211	95.4	0.0
25	35,014	18,906	0.4	163.0	3,220	7,100	94.8	-0.1
0	35,786	19,323	0.0	Undefined	3,192	7,037	95.5	0.0

Notes:  
 Launch Site: CCAFS SLC-41  
 Park Orbit Perigee Altitude  $\geq$  167 km (90 nmi)  
 Park Orbit Coast  $\leq$  2 Hours  
 Transfer Orbit Perigee Altitude  $\geq$  185 km (100 nmi)  
 Transfer Orbit Argument of Perigee = 180 deg  
 Confidence Level: 2.33 Sigma GCS  
 Apogee is at 1st SC Apogee, Perigee and Inclination are at SC Separation, True Anomaly is at Injection  
 Latitude and East Longitude are taken at SC Separation  
 Only oblate Earth effects were taken into account when propagating to 1st SC Apogee

Figure 2.6.3-3c: Atlas V 541 Minimum  $\Delta V$  to Geosynchronous Orbit (3 Burn)

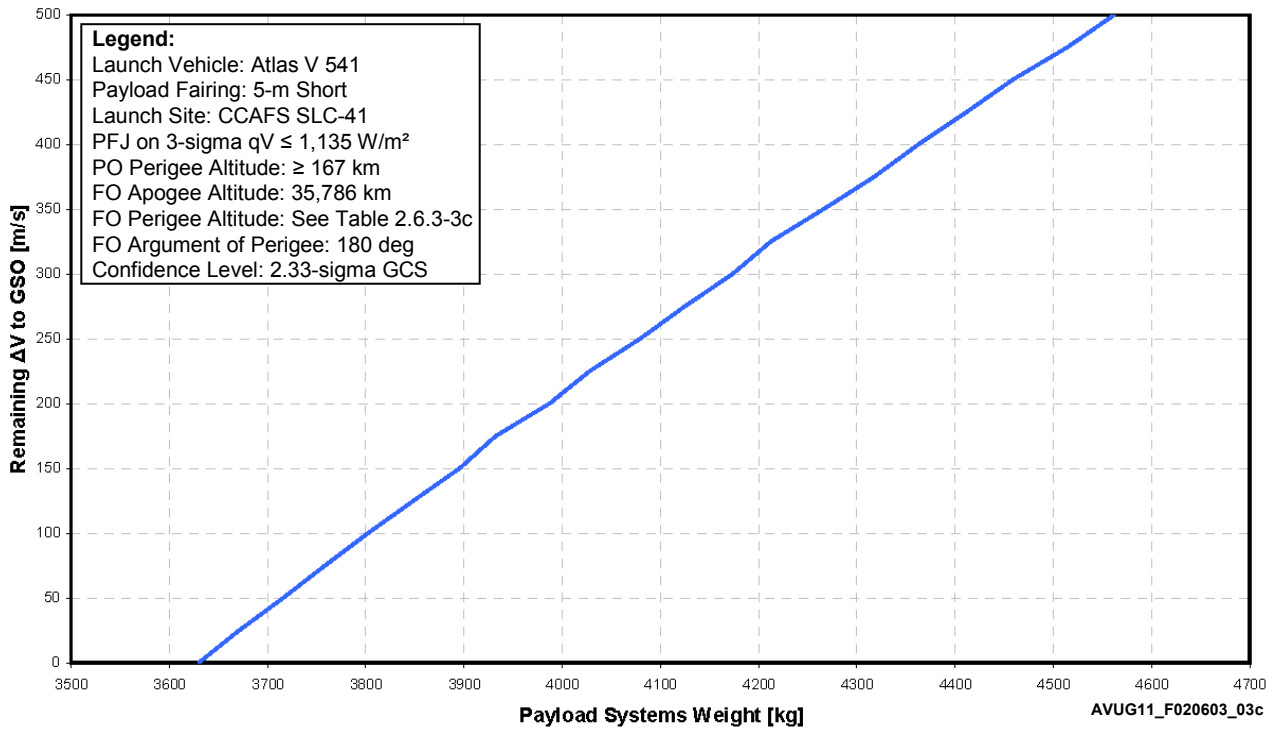




Table 2.6.3-3c: Atlas V 541 Minimum  $\Delta V$  to Geosynchronous Orbit (3 Burn) — Apogee Cap

Atlas V 541 GTO — $\Delta V$ to GSO at 35,786 km (19,323 nmi)								
$\Delta V$ to GSO	Perigee		Inclination	True Anomaly	Payload Systems Weight		Longitude	Latitude
	[m/s]	[km]			[nmi]	[deg]		
500	17,791	9,607	4.4	-179.4	4,562	10,057	95.2	0.0
475	18,374	9,921	4.1	-179.1	4,514	9,952	95.3	0.1
450	19,080	10,302	3.9	-178.6	4,459	9,831	95.2	0.1
425	19,786	10,684	3.6	-179.2	4,412	9,726	95.5	0.1
400	20,562	11,103	3.5	-178.8	4,363	9,619	95.4	0.1
375	21,212	11,454	3.1	-179.0	4,317	9,518	95.5	0.1
350	21,991	11,874	2.9	-179.5	4,266	9,405	95.5	0.0
325	22,622	12,215	2.5	-176.2	4,212	9,287	95.5	0.2
300	23,521	12,700	2.4	-178.7	4,174	9,201	95.5	0.1
275	24,398	13,174	2.2	-178.9	4,125	9,093	95.5	0.0
250	25,265	13,642	2.0	-178.8	4,080	8,994	95.5	0.0
225	26,232	14,164	1.9	-179.0	4,028	8,879	95.3	0.0
200	27,096	14,631	1.6	-178.7	3,987	8,790	95.5	0.0
175	27,952	15,093	1.3	179.7	3,932	8,669	95.2	0.0
150	29,022	15,671	1.2	-179.0	3,895	8,588	95.5	0.0
125	30,056	16,229	1.0	-179.7	3,849	8,485	95.5	0.0
100	31,124	16,806	0.8	179.9	3,803	8,384	95.6	0.0
75	32,216	17,395	0.6	-178.6	3,759	8,287	95.6	0.0
50	33,360	18,013	0.4	-177.4	3,716	8,192	95.6	0.0
25	34,569	18,666	0.2	172.2	3,671	8,094	95.5	0.0
0	35,786	19,323	0.0	Undefined	3,630	8,003	95.6	0.0

Notes:  
 Launch Site: CCAFS SLC-41  
 Park Orbit Perigee Altitude  $\geq$  167 km (90 nmi)  
 Park Orbit Coast  $\leq$  2 Hours  
 Transfer Orbit Perigee Altitude  $\geq$  185 km (100 nmi)  
 Transfer Orbit Argument of Perigee = 180 deg  
 Confidence Level: 2.33 Sigma GCS  
 Apogee is at 1st SC Apogee, Perigee and Inclination are at SC Separation, True Anomaly is at Injection  
 Latitude and East Longitude are taken at SC Separation  
 Only oblate Earth effects were taken into account when propagating to 1st SC Apogee

Figure 2.6.3-3d: Atlas V 551 Minimum  $\Delta V$  to Geosynchronous Orbit (3 Burn)

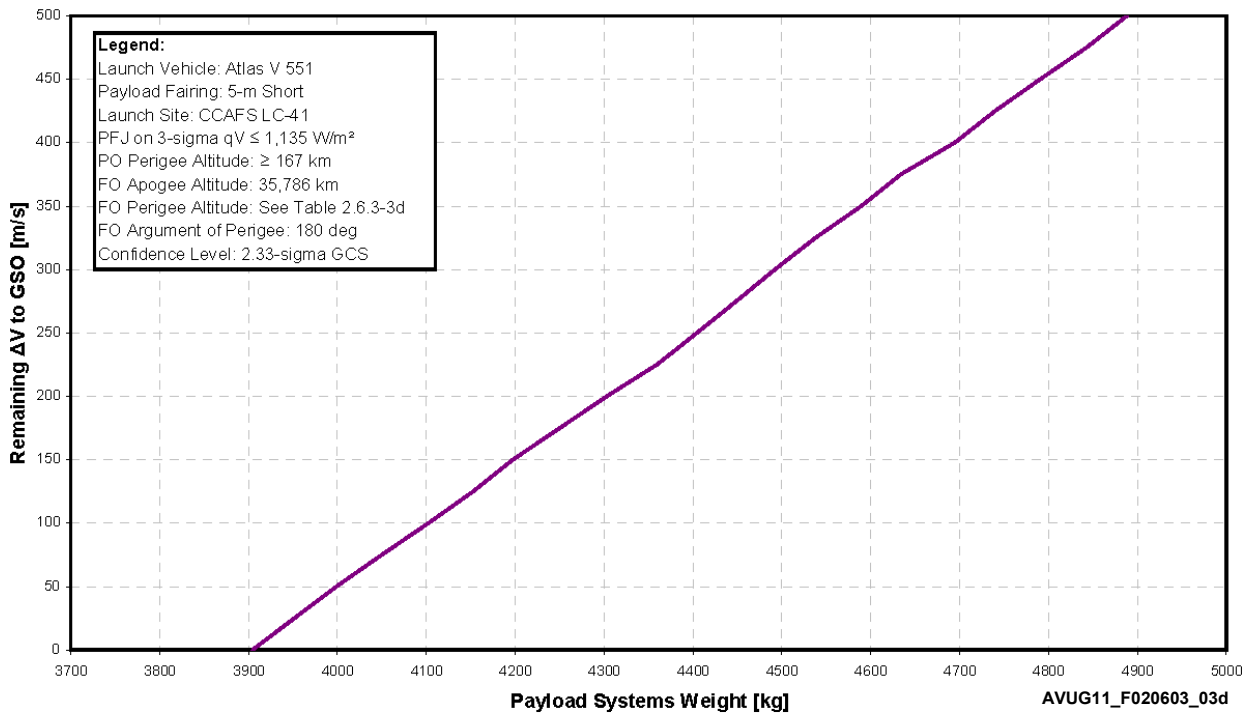


Table 2.6.3-3d: Atlas V 551 Minimum  $\Delta V$  to Geosynchronous Orbit (3 Burn) — Apogee Cap

Atlas V 551 GTO — $\Delta V$ to GSO at 35,786 km (19,323 nmi)								
$\Delta V$ to GSO	Perigee		Inclination	True Anomaly	Payload Systems Weight		Longitude	Latitude
[m/s]	[km]	[nmi]	[deg]	[deg]	[kg]	[lb]	[deg]	[deg]
500	17,281	9,331	3.6	-178.0	4,889	10,778	95.0	0.1
475	17,772	9,596	3.0	-178.0	4,842	10,676	93.6	0.1
450	19,133	10,331	3.9	-179.5	4,791	10,562	95.4	0.0
425	19,904	10,747	3.8	-179.5	4,740	10,450	95.6	0.0
400	20,573	11,109	3.5	-179.5	4,695	10,350	95.3	0.0
375	21,290	11,496	3.2	-179.0	4,634	10,217	95.4	0.1
350	21,967	11,861	2.9	-178.8	4,590	10,118	95.4	0.1
325	21,957	11,856	1.3	-178.0	4,538	10,005	90.3	0.0
300	22,981	12,409	1.6	-178.0	4,492	9,904	93.1	0.1
275	24,459	13,207	2.3	-178.6	4,449	9,807	95.3	0.1
250	25,203	13,608	1.9	-178.8	4,405	9,711	95.3	0.0
225	26,152	14,121	1.8	-178.8	4,360	9,612	95.5	0.0
200	27,078	14,621	1.6	-179.1	4,304	9,488	95.3	0.0
175	28,036	15,138	1.4	-178.4	4,250	9,370	95.3	0.0
150	28,982	15,649	1.1	-178.9	4,198	9,254	95.4	0.0
125	30,042	16,221	1.0	-178.4	4,153	9,156	95.5	0.0
100	31,127	16,807	0.8	-179.2	4,103	9,045	95.4	0.0
75	32,038	17,299	0.4	-178.0	4,051	8,930	95.4	0.0
50	33,347	18,006	0.4	-179.5	3,999	8,817	95.5	0.0
25	34,556	18,659	0.2	-178.8	3,952	8,712	95.5	0.0
0	35,786	19,323	0.0	Undefined	3,904	8,608	95.5	0.0

Notes:  
 Launch Site: CCAFS SLC-41  
 Park Orbit Perigee Altitude  $\geq$  167 km (90 nmi)  
 Park Orbit Coast  $\leq$  2 Hours  
 Transfer Orbit Perigee Altitude  $\geq$  185 km (100 nmi)  
 Transfer Orbit Argument of Perigee = 180 deg  
 Confidence Level: 2.33 Sigma GCS  
 Apogee is at 1st SC Apogee, Perigee and Inclination are at SC Separation, True Anomaly is at Injection  
 Latitude and East Longitude are taken at SC Separation  
 Only oblate Earth effects were taken into account when propagating to 1st SC Apogee

Figure 2.6.5-1: Atlas V 401-431 Low Earth Orbit Performance — CCAFS (28.5 deg)

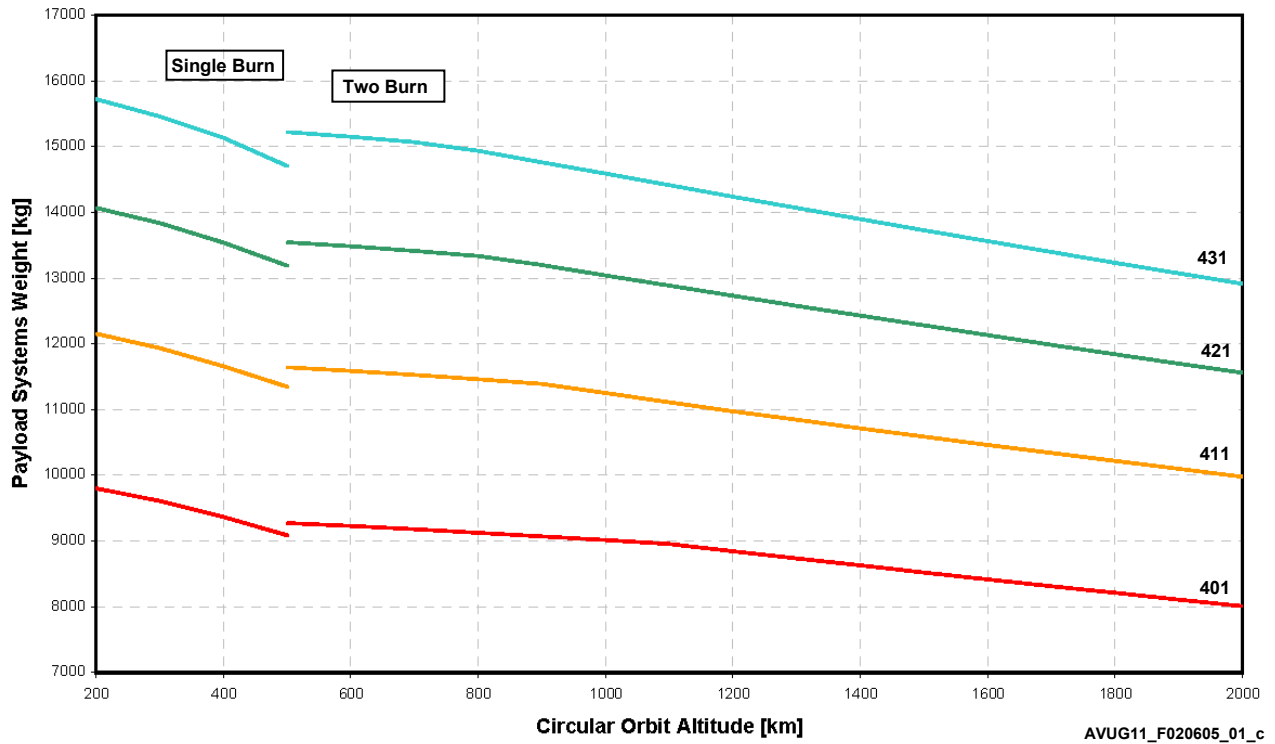


Figure 2.6.5-1a: Atlas V 401 Low Earth Orbit Performance — CCAFS

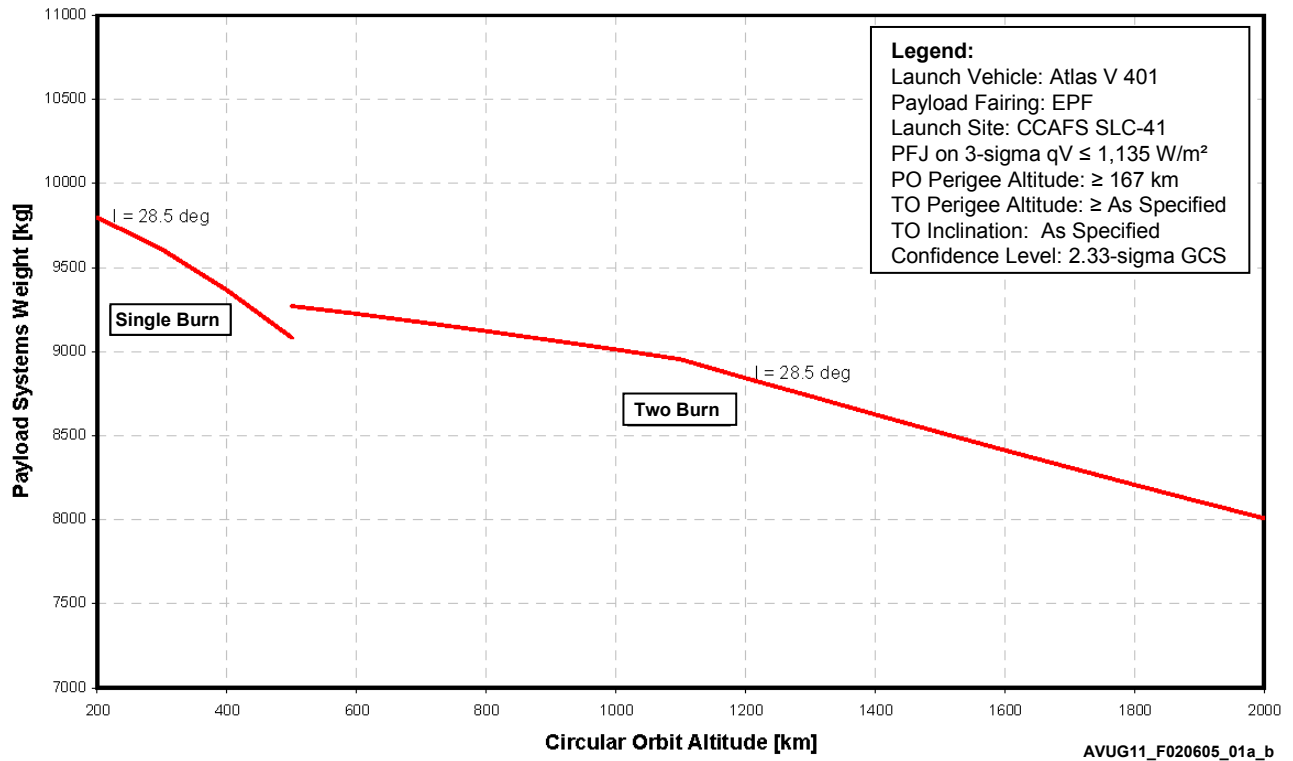


Table 2.6.5-1a: Atlas V 401 Low Earth Orbit Performance — PSW vs Altitude

Atlas V 401 LEO — CCAFS			
Circular Orbit		Payload Systems Weight	
Altitude		I = 28.5 deg	
[km]	[nmi]	[kg]	[lb]
<b>Two Burn</b>			
2,000	1,080	8,008	17,655
1,900	1,026	8,107	17,873
1,800	972	8,207	18,094
1,700	918	8,309	18,318
1,600	864	8,413	18,546
1,500	810	8,518	18,779
1,400	756	8,625	19,016
1,300	702	8,733	19,253
1,200	648	8,842	19,494
1,100	594	8,952	19,736
1,000	540	9,011	19,867
900	486	9,067	19,990
800	432	9,122	20,110
700	378	9,174	20,226
600	324	9,224	20,335
500	270	9,269	20,435
<b>Single Burn</b>			
500	270	9,083	20,024
400	216	9,365	20,645
300	162	9,607	21,180
200	108	9,797	21,598

**Notes:**  
 Launch Site: CCAFS SLC-41  
 Payload Fairing: EPF  
 PFJ at 3-sigma qV ≤ 1,135 W/m<sup>2</sup> (360 BTU/ft<sup>2</sup>-hr)  
 Park Orbit Perigee Altitude ≥ 167 km (90 nmi)  
 Confidence Level: 2.33 Sigma GCS

Figure 2.6.5-1b: Atlas V 411 Low Earth Orbit Performance — CCAFS

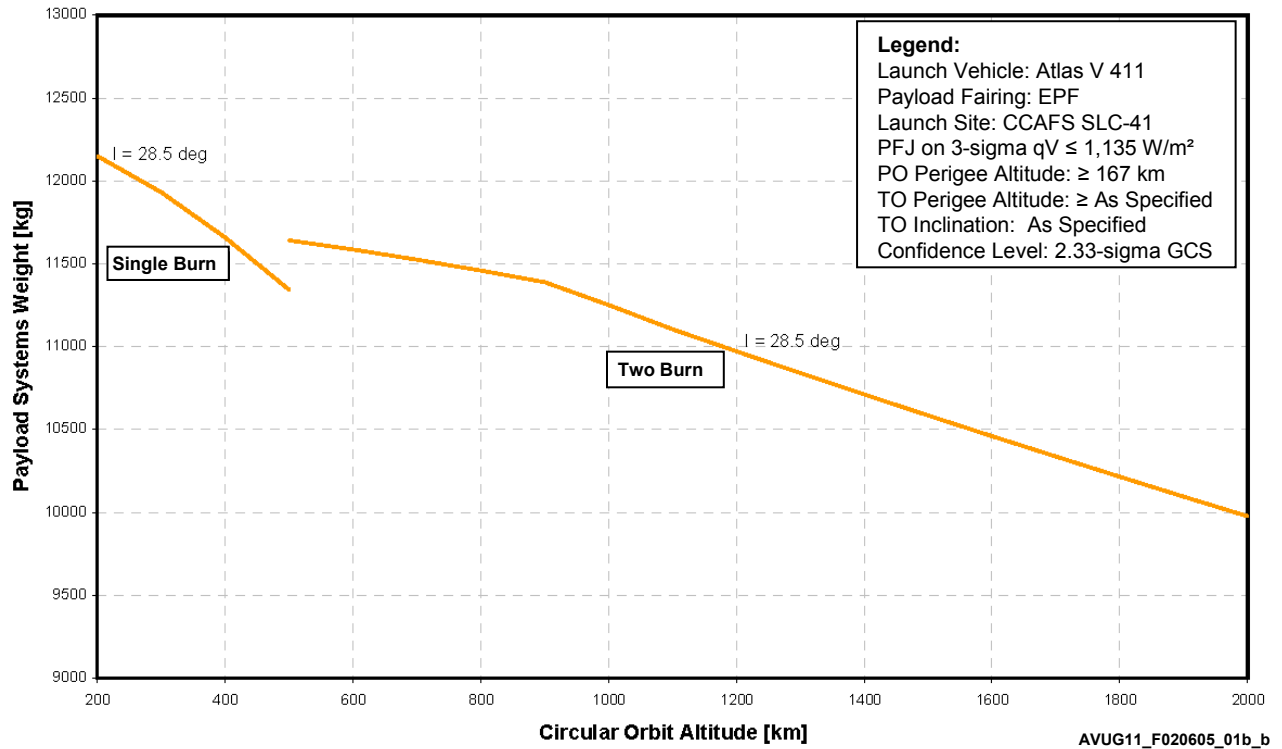


Table 2.6.5-1b: Atlas V 411 Low Earth Orbit Performance — PSW vs Altitude

Atlas V 411 LEO — CCAFS			
Circular Orbit		Payload Systems Weight	
Altitude		I = 28.5 deg	
[km]	[nmi]	[kg]	[lb]
<b>Two Burn</b>			
2,000	1,080	9,976	21,994
1,900	1,026	10,094	22,254
1,800	972	10,214	22,518
1,700	918	10,335	22,786
1,600	864	10,459	23,057
1,500	810	10,584	23,333
1,400	756	10,711	23,614
1,300	702	10,840	23,899
1,200	648	10,971	24,187
1,100	594	11,104	24,480
1,000	540	11,251	24,804
900	486	11,388	25,106
800	432	11,459	25,262
700	378	11,524	25,406
600	324	11,585	25,540
500	270	11,641	25,663
<b>Single Burn</b>			
500	270	11,342	25,005
400	216	11,656	25,698
300	162	11,931	26,303
200	108	12,150	26,787

**Notes:**  
 Launch Site: CCAFS SLC-41  
 Payload Fairing: EPF  
 PFJ at 3-sigma qV ≤ 1,135 W/m<sup>2</sup> (360 BTU/ft<sup>2</sup>-hr)  
 Park Orbit Perigee Altitude ≥ 167 km (90 nmi)  
 Confidence Level: 2.33 Sigma GCS

Figure 2.6.5-1c: Atlas V 421 Low Earth Orbit Performance — CCAFS

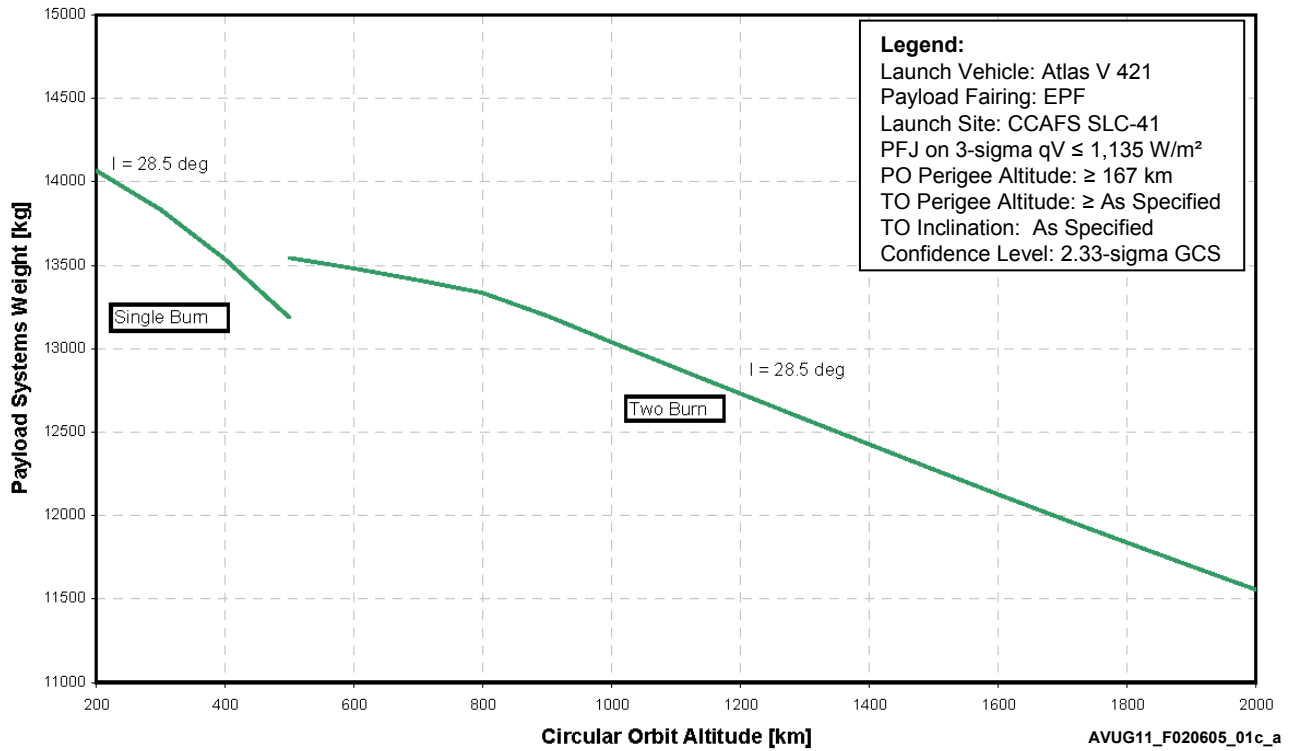




Table 2.6.5-1c: Atlas V 421 Low Earth Orbit Performance — PSW vs Altitude

Atlas V 421 LEO — CCAFS			
Circular Orbit		Payload Systems Weight	
Altitude		i = 28.5 deg	
[km]	[nmi]	[kg]	[lb]
<b>Two Burn</b>			
2,000	1,080	11,555	25,474
1,900	1,026	11,695	25,782
1,800	972	11,837	26,095
1,700	918	11,981	26,413
1,600	864	12,127	26,735
1,500	810	12,275	27,062
1,400	756	12,425	27,393
1,300	702	12,576	27,726
1,200	648	12,729	28,063
1,100	594	12,883	28,403
1,000	540	13,038	28,744
900	486	13,196	29,093
800	432	13,333	29,394
700	378	13,409	29,562
600	324	13,480	29,719
500	270	13,544	29,859
<b>Single Burn</b>			
500	270	13,185	29,069
400	216	13,535	29,839
300	162	13,832	30,495
200	108	14,067	31,012

**Notes:**  
 Launch Site: CCAFS SLC-41  
 Payload Fairing: EPF  
 PFJ at 3-sigma qV ≤ 1,135 W/m<sup>2</sup> (360 BTU/ft<sup>2</sup>-hr)  
 Park Orbit Perigee Altitude ≥ 167 km (90 nmi)  
 Confidence Level: 2.33 Sigma GCS

Figure 2.6.5-1d: Atlas V 431 Low Earth Orbit Performance — CCAFS

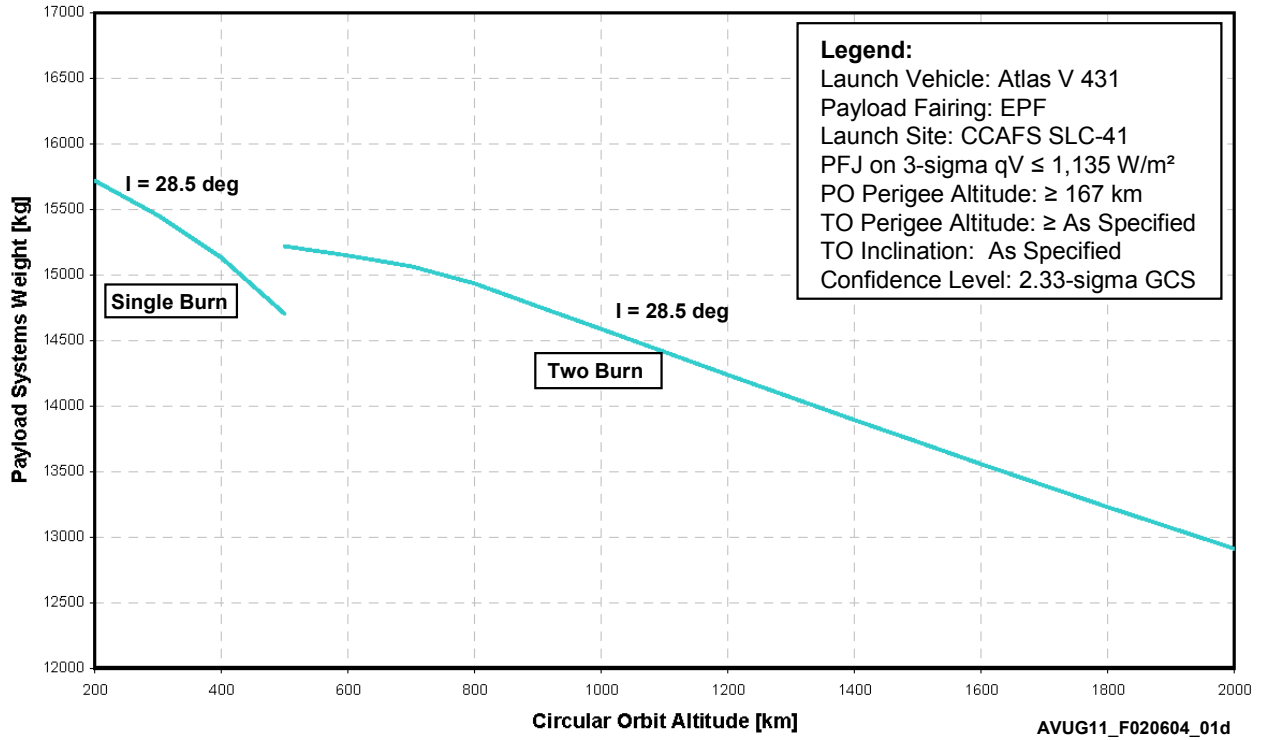


Table 2.6.5-1d: Atlas V 431 Low Earth Orbit Performance — PSW vs Altitude

Atlas V 431 LEO — CCAFS			
Circular Orbit		Payload Systems Weight	
Altitude		I = 28.5 deg	
[km]	[nmi]	[kg]	[lb]
<b>Two Burn</b>			
2,000	1,080	12,911	28,463
1,900	1,026	13,069	28,812
1,800	972	13,229	29,164
1,700	918	13,391	29,522
1,600	864	13,556	29,886
1,500	810	13,724	30,255
1,400	756	13,893	30,629
1,300	702	14,064	31,007
1,200	648	14,237	31,386
1,100	594	14,411	31,770
1,000	540	14,585	32,154
900	486	14,759	32,538
800	432	14,933	32,922
700	378	15,066	33,214
600	324	15,146	33,392
500	270	15,218	33,550
<b>Single Burn</b>			
500	270	14,700	32,409
400	216	15,130	33,356
300	162	15,453	34,067
200	108	15,718	34,653

Notes:  
 Launch Site: CCAFS SLC-41  
 Payload Fairing: EPF  
 PFJ at 3-sigma qV ≤ 1,135 W/m<sup>2</sup> (360 BTU/ft<sup>2</sup>-hr)  
 Park Orbit Perigee Altitude ≥ 167 km (90 nmi)  
 Confidence Level: 2.33 Sigma GCS

Figure 2.6.5-2: Atlas V 501-551 Low Earth Orbit Performance — CCAFS (28.5 deg)

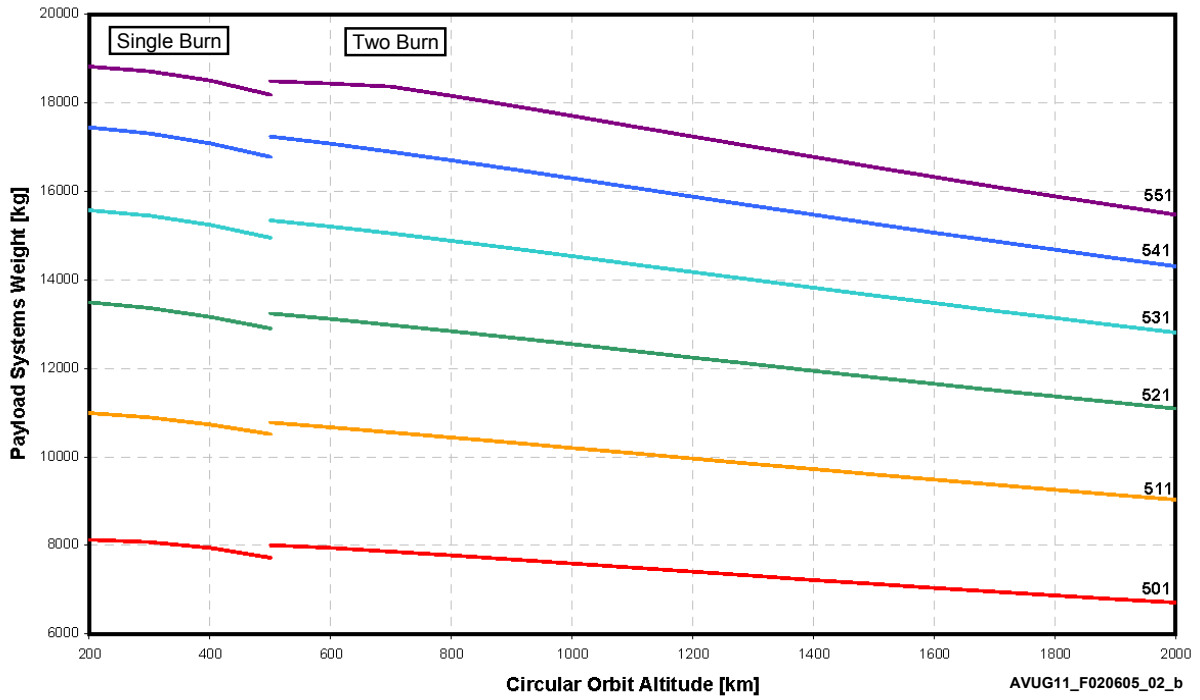


Figure 2.6.5-2a: Atlas V 501 Low Earth Orbit Performance — CCAFS

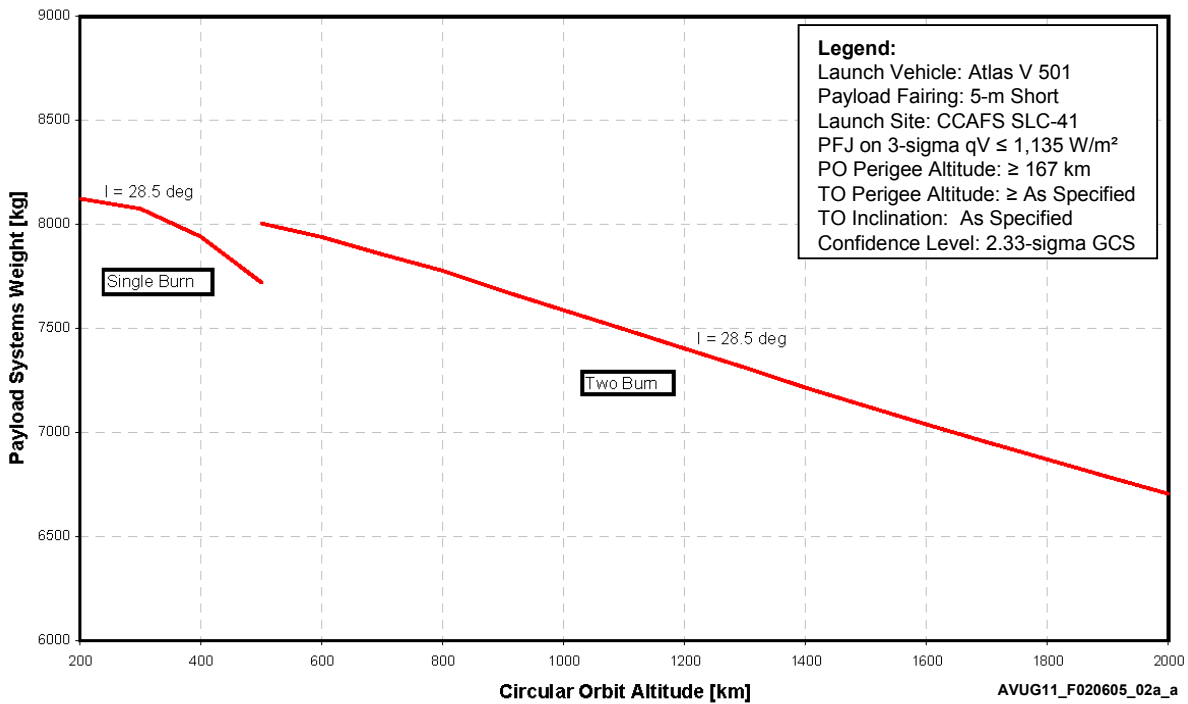


Table 2.6.5-2a: Atlas V 501 Low Earth Orbit Performance — PSW vs Altitude

Atlas V 501 LEO — CCAFS			
Circular Orbit		Payload Systems Weight	
Altitude		I = 28.5 deg	
[km]	[nmi]	[kg]	[lb]
<b>Two Burn</b>			
2,000	1,080	6,704	14,780
1,900	1,026	6,786	14,961
1,800	972	6,869	15,144
1,700	918	6,953	15,330
1,600	864	7,039	15,518
1,500	810	7,126	15,710
1,400	756	7,214	15,905
1,300	702	7,311	16,118
1,200	648	7,403	16,322
1,100	594	7,496	16,525
1,000	540	7,588	16,729
900	486	7,680	16,930
800	432	7,777	17,144
700	378	7,856	17,320
600	324	7,939	17,502
500	270	8,005	17,647
<b>Single Burn</b>			
500	270	7,721	17,021
400	216	7,941	17,507
300	162	8,075	17,802
200	108	8,123	17,908

**Notes:**  
 Launch Site: CCAFS SLC-41  
 Payload Fairing: 5-m Short  
 PFJ at 3-sigma qV ≤ 1,135 W/m<sup>2</sup> (360 BTU/ft<sup>2</sup>-hr)  
 Park Orbit Perigee Altitude ≥ 167 km (90 nmi)  
 Confidence Level: 2.33 Sigma GCS

Figure 2.6.5-2b: Atlas V 511 Low Earth Orbit Performance — CCAFS

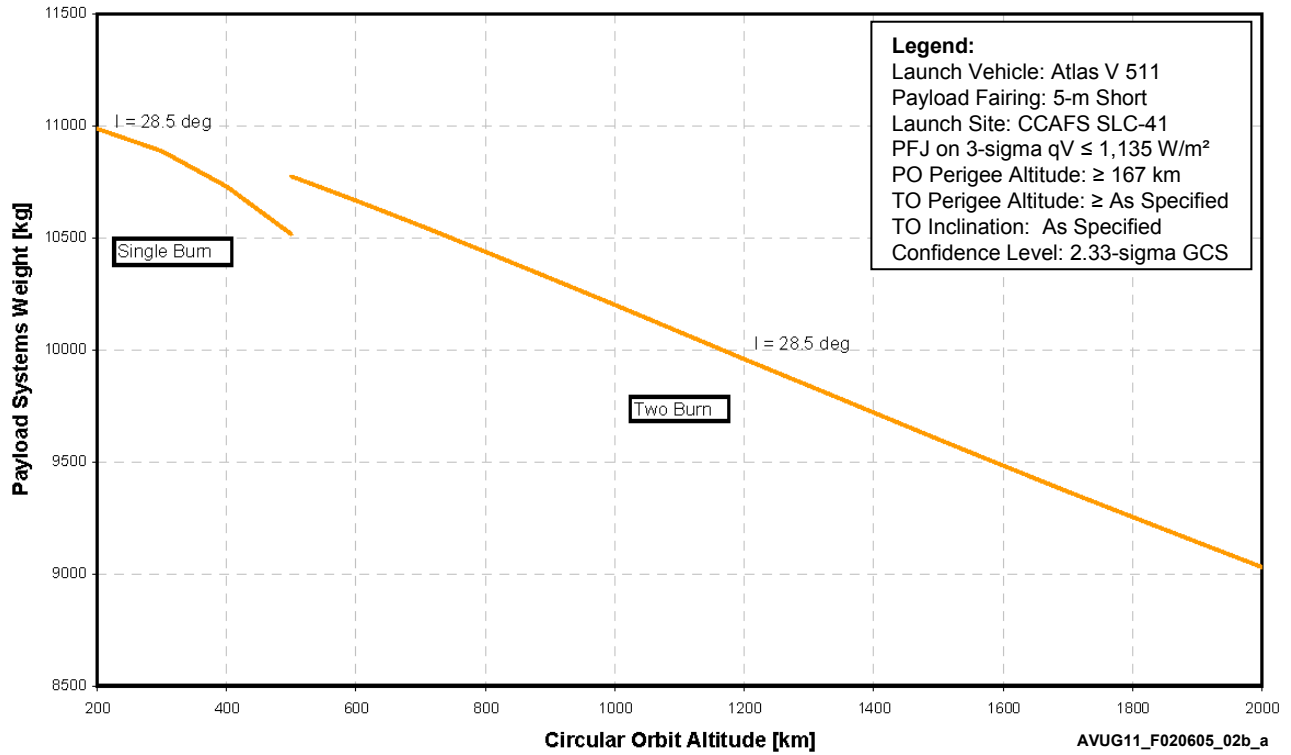


Table 2.6.5-2b: Atlas V 511 Low Earth Orbit Performance — PSW vs Altitude

Atlas V 511 LEO — CCAFS			
Circular Orbit		Payload Systems Weight	
Altitude		I = 28.5 deg	
[km]	[nmi]	[kg]	[lb]
<b>Two Burn</b>			
2,000	1,080	9,030	19,907
1,900	1,026	9,141	20,151
1,800	972	9,253	20,399
1,700	918	9,367	20,651
1,600	864	9,483	20,906
1,500	810	9,600	21,165
1,400	756	9,719	21,427
1,300	702	9,839	21,691
1,200	648	9,959	21,956
1,100	594	10,080	22,222
1,000	540	10,200	22,488
900	486	10,320	22,752
800	432	10,438	23,011
700	378	10,553	23,266
600	324	10,666	23,514
500	270	10,774	23,752
<b>Single Burn</b>			
500	270	10,516	23,184
400	216	10,728	23,652
300	162	10,887	24,001
200	108	10,986	24,221

**Notes:**  
 Launch Site: CCAFS SLC-41  
 Payload Fairing: 5-m Short  
 PFJ at 3-sigma qV ≤ 1,135 W/m<sup>2</sup> (360 BTU/ft<sup>2</sup>-hr)  
 Park Orbit Perigee Altitude ≥ 167 km (90 nmi)  
 Confidence Level: 2.33 Sigma GCS

Figure 2.6.5-2c: Atlas V 521 Low Earth Orbit Performance — CCAFS

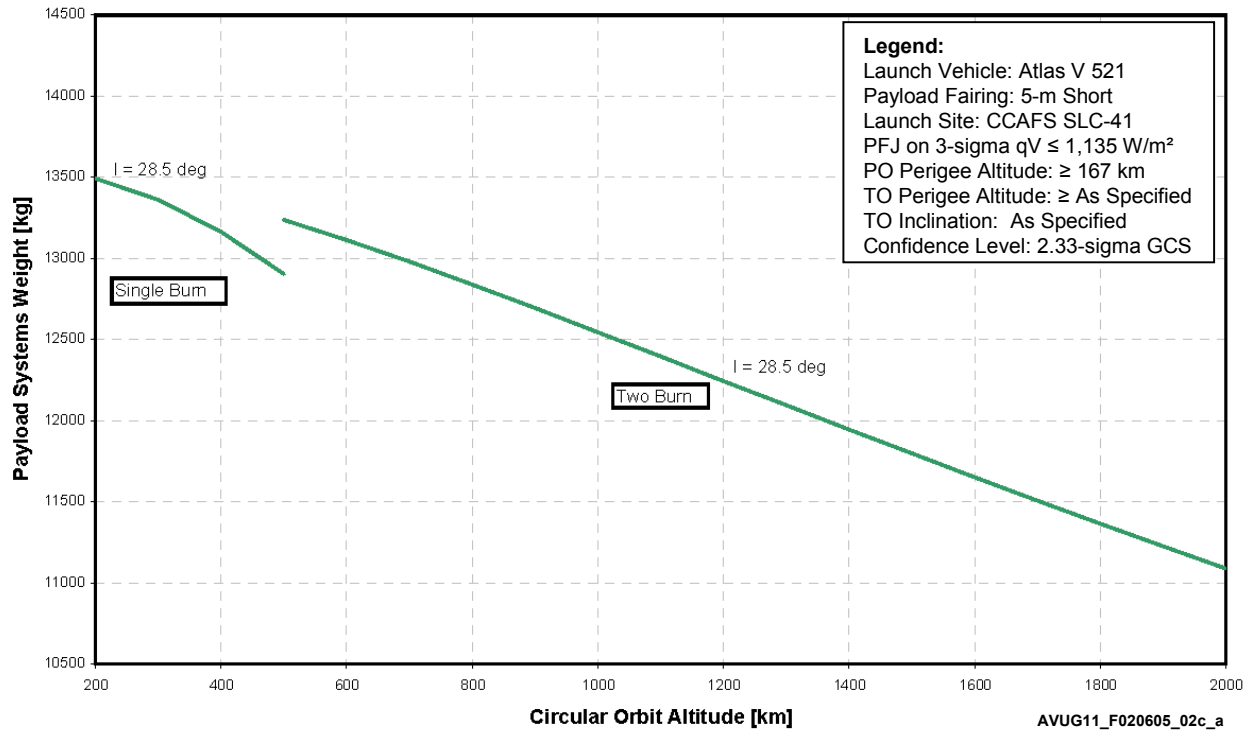




Table 2.6.5-2c: Atlas V 521 Low Earth Orbit Performance — PSW vs Altitude

Atlas V 521 LEO — CCAFS			
Circular Orbit		Payload Systems Weight	
Altitude		I = 28.5 deg	
[km]	[nmi]	[kg]	[lb]
<b>Two Burn</b>			
2,000	1,080	11,087	24,443
1,900	1,026	11,225	24,746
1,800	972	11,364	25,053
1,700	918	11,506	25,366
1,600	864	11,650	25,683
1,500	810	11,796	26,006
1,400	756	11,943	26,330
1,300	702	12,093	26,660
1,200	648	12,243	26,991
1,100	594	12,393	27,322
1,000	540	12,544	27,654
900	486	12,692	27,981
800	432	12,838	28,302
700	378	12,978	28,612
600	324	13,112	28,907
500	270	13,235	29,179
<b>Single Burn</b>			
500	270	12,903	28,446
400	216	13,163	29,019
300	162	13,360	29,453
200	108	13,490	29,741

**Notes:**  
 Launch Site: CCAFS SLC-41  
 Payload Fairing: 5-m Short  
 PFJ at 3-sigma qV ≤ 1,135 W/m<sup>2</sup> (360 BTU/ft<sup>2</sup>-hr)  
 Park Orbit Perigee Altitude ≥ 167 km (90 nmi)  
 Confidence Level: 2.33 Sigma GCS

Figure 2.6.5-2d: Atlas V 531 Low Earth Orbit Performance — CCAFS

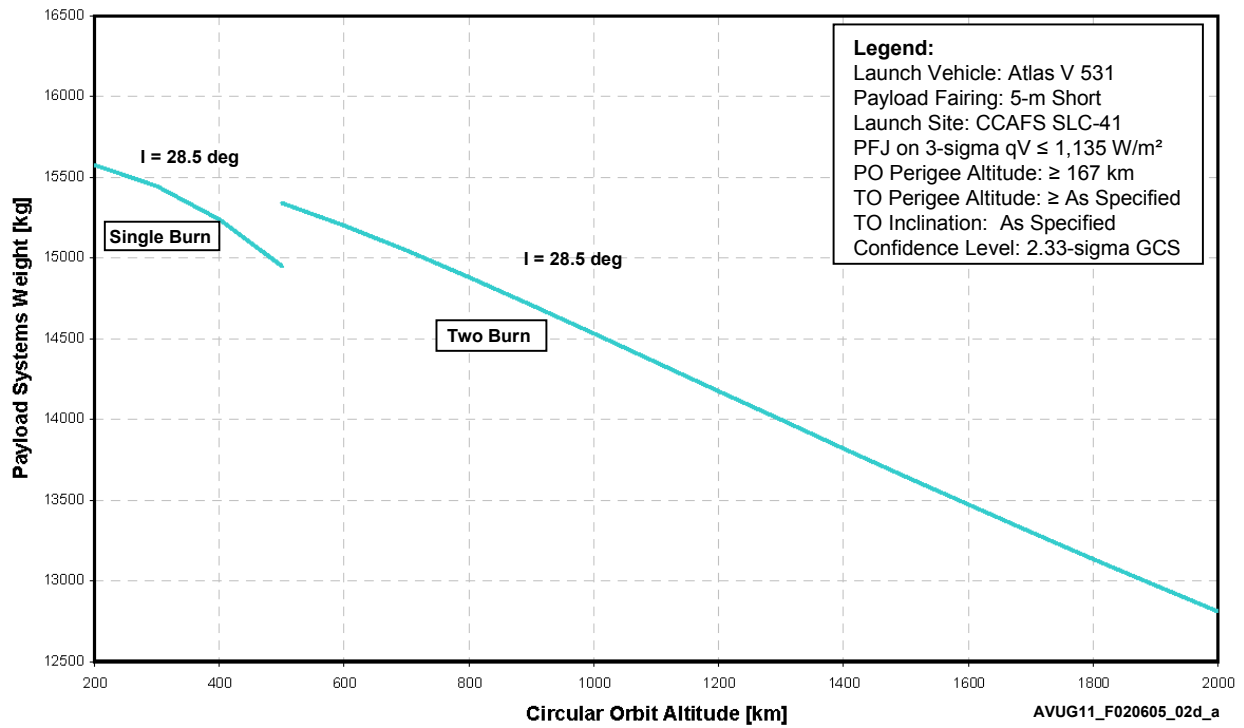


Table 2.6.5-2d: Atlas V 531 Low Earth Orbit Performance — PSW vs Altitude

Atlas V 531 LEO — CCAFS			
Circular Orbit		Payload Systems Weight	
Altitude		i = 28.5 deg	
[km]	[nmi]	[kg]	[lb]
<b>Two Burn</b>			
2,000	1,080	12,809	28,238
1,900	1,026	12,970	28,594
1,800	972	13,135	28,958
1,700	918	13,302	29,326
1,600	864	13,472	29,701
1,500	810	13,645	30,082
1,400	756	13,820	30,467
1,300	702	13,996	30,857
1,200	648	14,173	31,247
1,100	594	14,353	31,643
1,000	540	14,531	32,036
900	486	14,708	32,427
800	432	14,881	32,806
700	378	15,046	33,171
600	324	15,201	33,513
500	270	15,340	33,819
<b>Single Burn</b>			
500	270	14,950	32,959
400	216	15,237	33,593
300	162	15,445	34,051
200	108	15,575	34,337

**Notes:**  
 Launch Site: CCAFS SLC-41  
 Payload Fairing: 5-m Short  
 PFJ at 3-sigma qV ≤ 1,135 W/m<sup>2</sup> (360 BTU/ft<sup>2</sup>-hr)  
 Park Orbit Perigee Altitude ≥ 167 km (90 nmi)  
 Confidence Level: 2.33 Sigma GCS

Figure 2.6.5-2e: Atlas V 541 Low Earth Orbit Performance — CCAFS

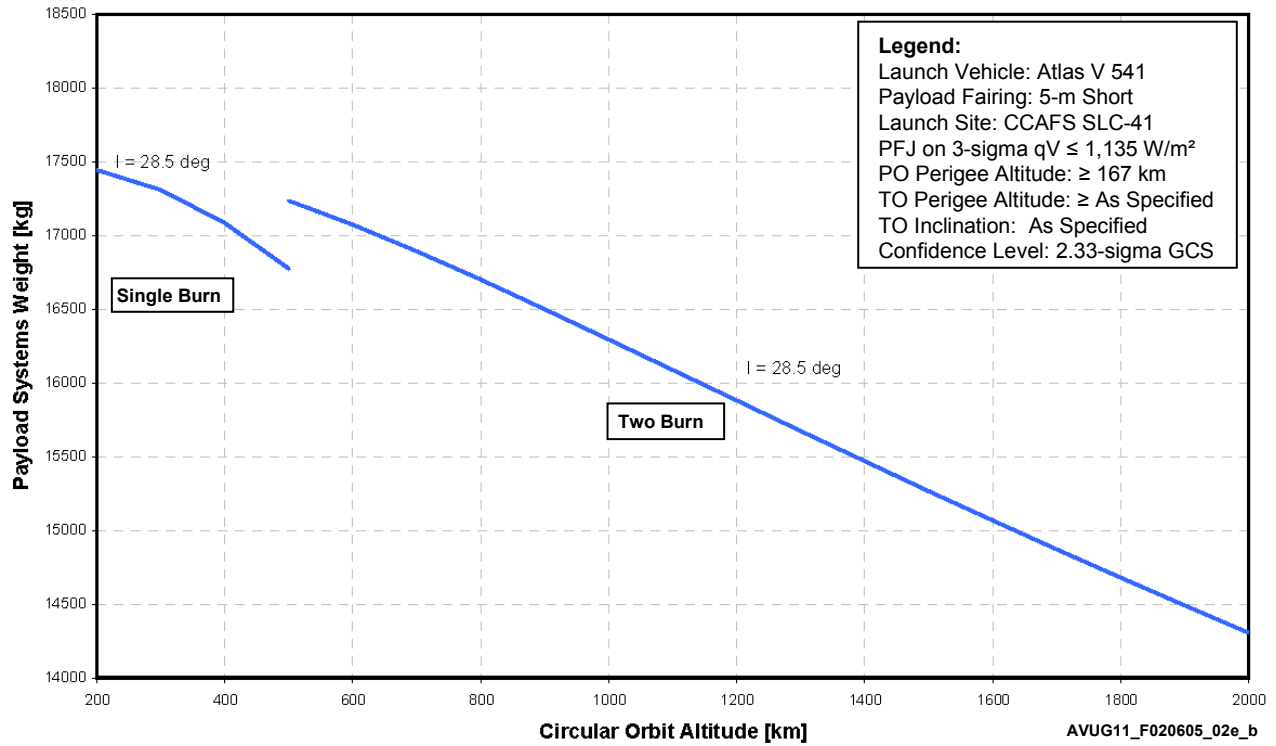


Table 2.6.5-2e: Atlas V 541 Low Earth Orbit Performance — PSW vs Altitude

Atlas V 541 LEO — CCAFS			
Circular Orbit		Payload Systems Weight	
Altitude		I = 28.5 deg	
[km]	[nmi]	[kg]	[lb]
<b>Two Burn</b>			
2,000	1,080	14,304	31,536
1,900	1,026	14,490	31,944
1,800	972	14,678	32,361
1,700	918	14,871	32,785
1,600	864	15,067	33,217
1,500	810	15,266	33,656
1,400	756	15,469	34,103
1,300	702	15,673	34,553
1,200	648	15,880	35,009
1,100	594	16,087	35,466
1,000	540	16,294	35,922
900	486	16,499	36,374
800	432	16,700	36,816
700	378	16,892	37,240
600	324	17,073	37,640
500	270	17,234	37,995
<b>Single Burn</b>			
500	270	16,773	36,978
400	216	17,083	37,662
300	162	17,308	38,158
200	108	17,443	38,456

**Notes:**  
 Launch Site: CCAFS SLC-41  
 Payload Fairing: 5-m Short  
 PFJ at 3-sigma qV ≤ 1,135 W/m<sup>2</sup> (360 BTU/ft<sup>2</sup>-hr)  
 Park Orbit Perigee Altitude ≥ 167 km (90 nmi)  
 Confidence Level: 2.33 Sigma GCS

Figure 2.6.5-2f: Atlas V 551 Low Earth Orbit Performance — CCAFS

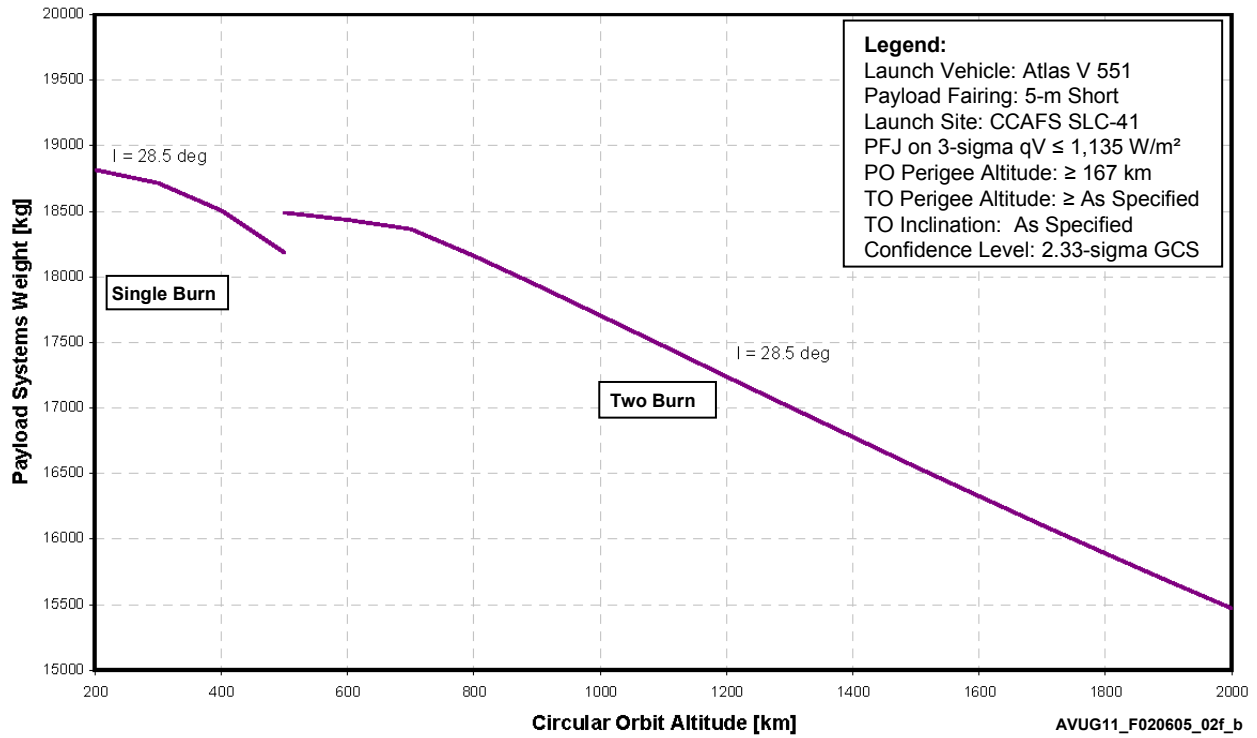


Table 2.6.5-2f: Atlas V 551 Low Earth Orbit Performance — PSW vs Altitude

Atlas V 551 LEO — CCAFS			
Circular Orbit		Payload Systems Weight	
Altitude		i = 28.5 deg	
[km]	[nmi]	[kg]	[lb]
<b>Two Burn</b>			
2,000	1,080	15,469	34,103
1,900	1,026	15,675	34,557
1,800	972	15,888	35,027
1,700	918	16,104	35,503
1,600	864	16,324	35,988
1,500	810	16,548	36,482
1,400	756	16,775	36,983
1,300	702	17,005	37,490
1,200	648	17,237	38,002
1,100	594	17,470	38,515
1,000	540	17,703	39,028
900	486	17,934	39,537
800	432	18,159	40,034
700	378	18,363	40,483
600	324	18,434	40,640
500	270	18,487	40,756
<b>Single Burn</b>			
500	270	18,182	40,083
400	216	18,505	40,796
300	162	18,713	41,256
200	108	18,814	41,478

**Notes:**  
 Launch Site: CCAFS SLC-41  
 Payload Fairing: 5-m Short  
 PFJ at 3-sigma qV ≤ 1,135 W/m<sup>2</sup> (360 BTU/ft<sup>2</sup>-hr)  
 Park Orbit Perigee Altitude ≥ 167 km (90 nmi)  
 Confidence Level: 2.33 Sigma GCS

Figure 2.6.6-1: Atlas V 401-431 Low Earth Orbit Performance — VAFB (90.0 deg)

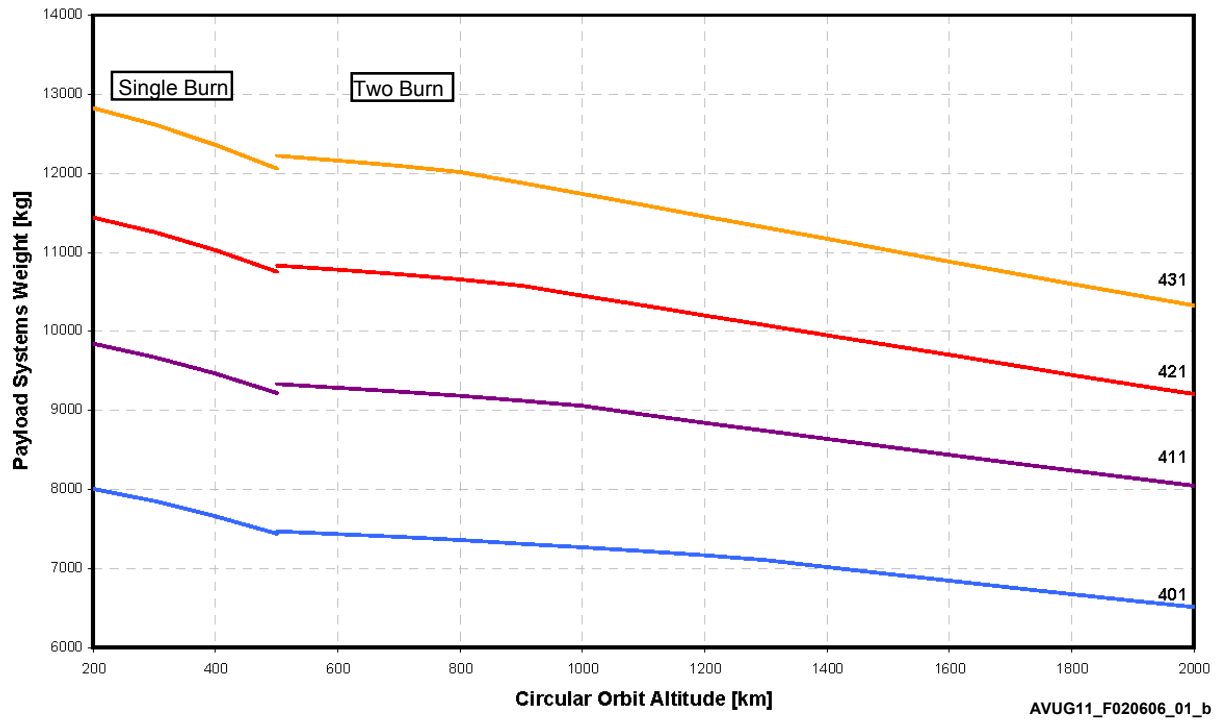




Figure 2.6.6-1-1: Atlas V 401-431 Low Earth Orbit Performance — VAFB (Sun-sync)

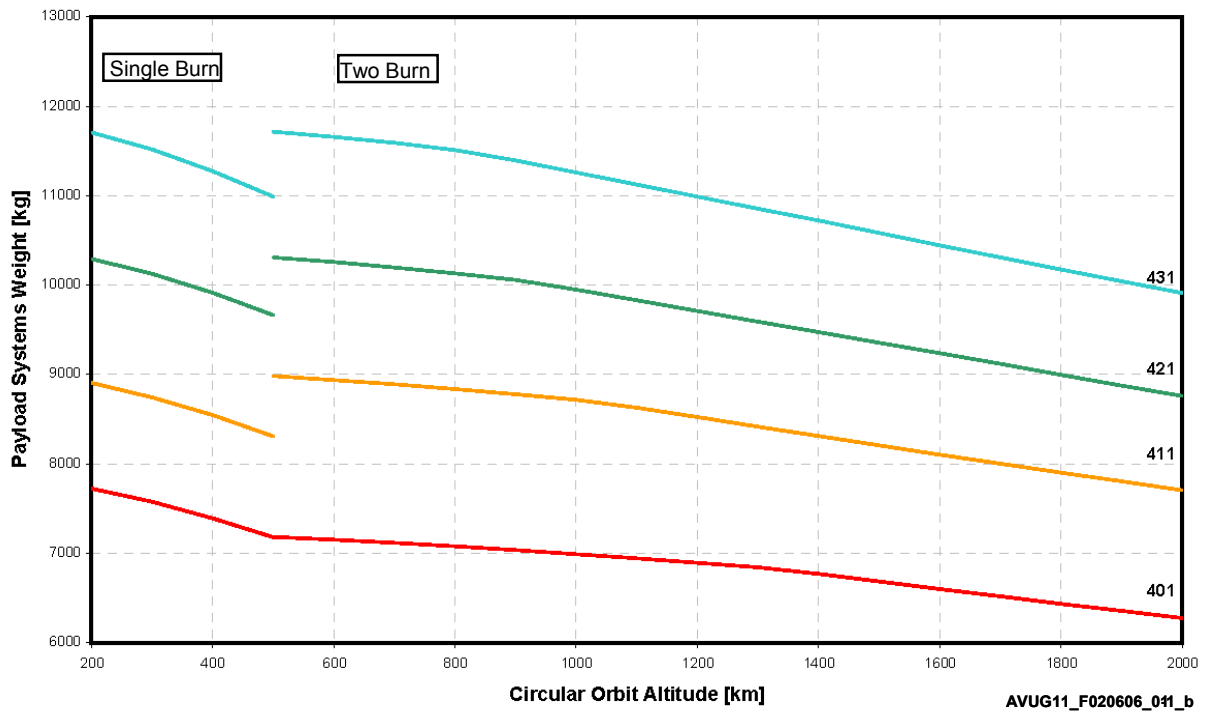


Figure 2.6.6-1a: Atlas V 401 Low Earth Orbit Performance — VAFB

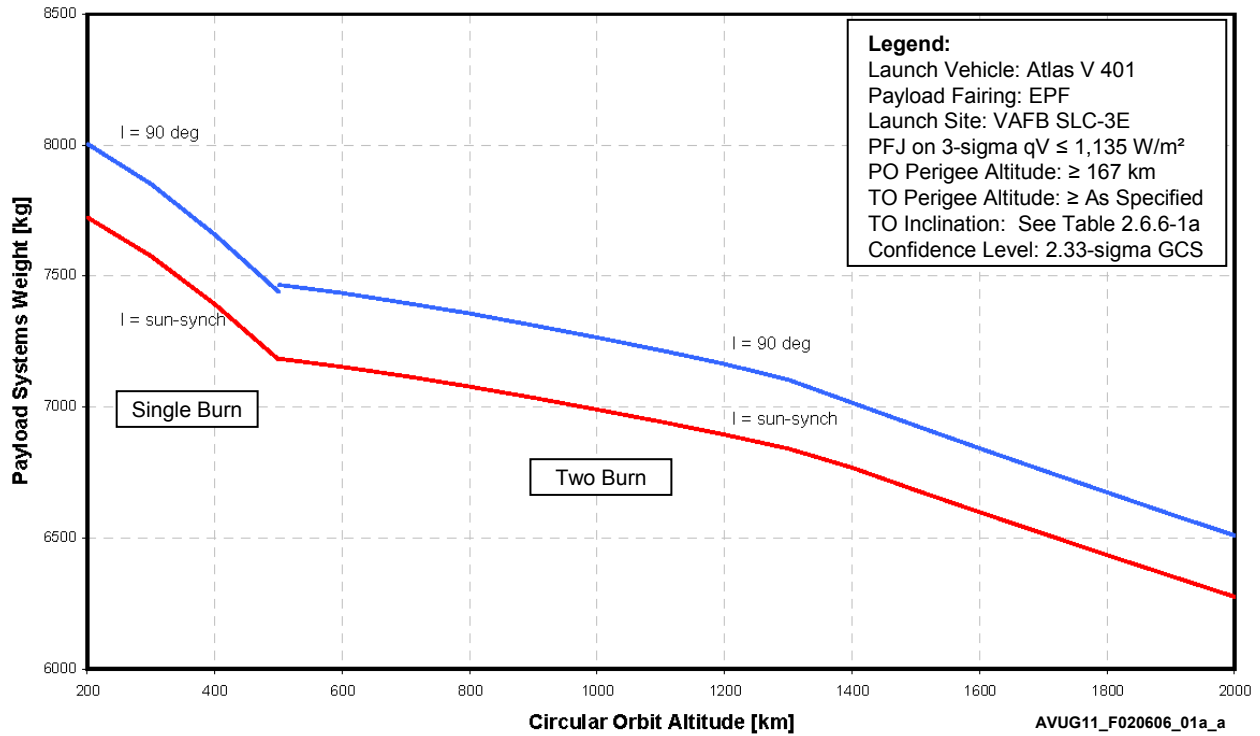


Table 2.6.6-1a: Atlas V 401 Low Earth Orbit Performance — PSW vs Altitude (VAFB)

Atlas V 401 LEO — VAFB					
Circular Orbit		Payload Systems Weight			
Altitude		I = 90 deg		Sun-Synch	
[km]	[nmi]	[kg]	[lb]	[kg]	[lb]
<b>Two Burn</b>					
2,000	1,080	6,509	14,351	6,276	13,836
1,900	1,026	6,591	14,530	6,355	14,009
1,800	972	6,673	14,712	6,435	14,186
1,700	918	6,757	14,897	6,516	14,365
1,600	864	6,842	15,085	6,599	14,547
1,500	810	6,929	15,276	6,682	14,732
1,400	756	7,017	15,469	6,767	14,920
1,300	702	7,104	15,662	6,840	15,081
1,200	648	7,164	15,794	6,894	15,198
1,100	594	7,216	15,909	6,943	15,307
1,000	540	7,266	16,018	6,990	15,411
900	486	7,312	16,120	7,035	15,510
800	432	7,356	16,218	7,077	15,603
700	378	7,397	16,308	7,117	15,689
600	324	7,434	16,390	7,152	15,768
500	270	7,467	16,461	7,184	15,837
<b>Single Burn</b>					
500	270	7,438	16,399	7,180	15,828
400	216	7,658	16,883	7,392	16,297
300	162	7,851	17,308	7,575	16,700
200	108	8,005	17,647	7,724	17,028

**Notes:**  
 Launch Site: VAFB SLC-3E  
 Payload Fairing: EPF  
 PFJ at 3-sigma qV ≤ 1,135 W/m<sup>2</sup> (360 BTU/ft<sup>2</sup>-hr)  
 Park Orbit Perigee Altitude ≥ 167 km (90 nmi)  
 Confidence Level: 2.33 Sigma GCS

Figure 2.6.6-1b: Atlas V 411 Low Earth Orbit Performance — VAFB

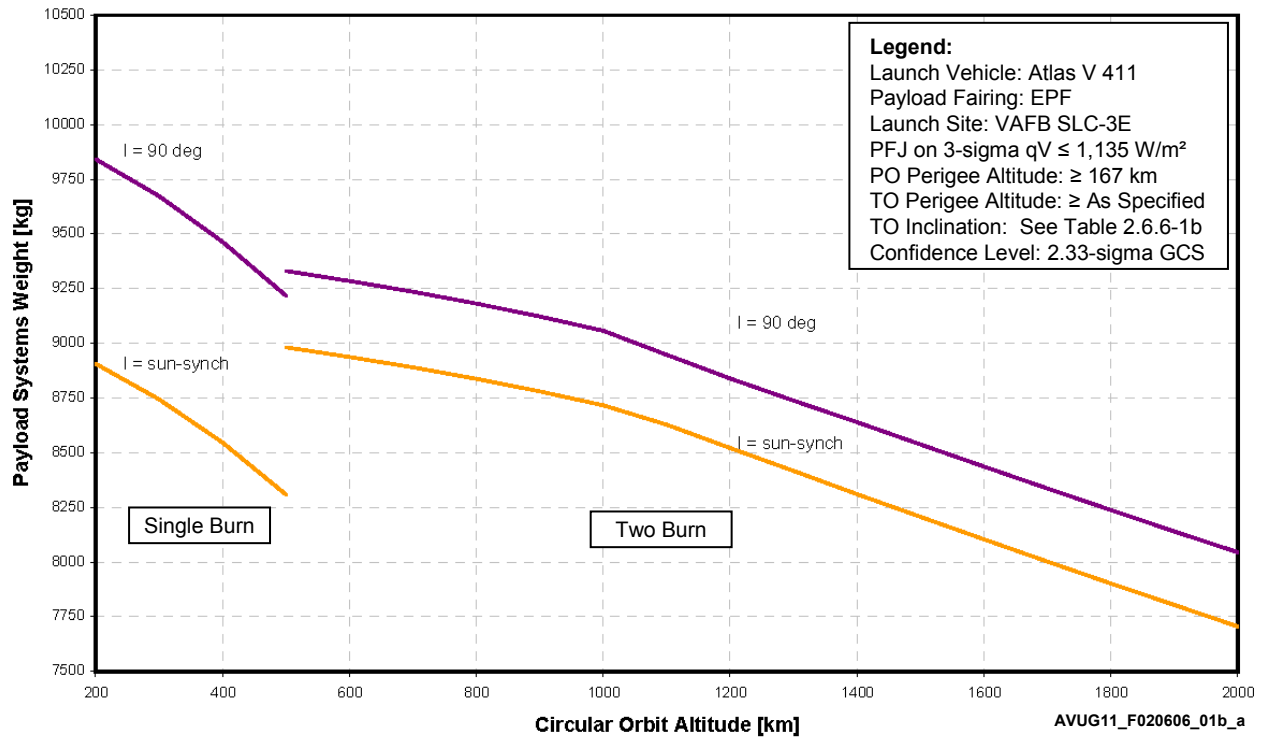


Table 2.6.6-1b: Atlas V 411 Low Earth Orbit Performance — PSW vs Altitude (VAFB)

Atlas V 411 LEO — VAFB					
Circular Orbit		Payload Systems Weight			
Altitude		I = 90 deg		Sun-Synch	
[km]	[nmi]	[kg]	[lb]	[kg]	[lb]
<b>Two Burn</b>					
2,000	1,080	8,043	17,732	7,704	16,985
1,900	1,026	8,139	17,944	7,803	17,202
1,800	972	8,237	18,159	7,902	17,420
1,700	918	8,336	18,377	8,001	17,640
1,600	864	8,436	18,597	8,103	17,864
1,500	810	8,537	18,820	8,206	18,091
1,400	756	8,639	19,046	8,310	18,320
1,300	702	8,738	19,263	8,415	18,552
1,200	648	8,838	19,485	8,521	18,786
1,100	594	8,947	19,725	8,627	19,020
1,000	540	9,056	19,965	8,716	19,215
900	486	9,122	20,111	8,779	19,354
800	432	9,181	20,241	8,836	19,481
700	378	9,235	20,360	8,889	19,597
600	324	9,285	20,470	8,938	19,704
500	270	9,330	20,569	8,982	19,801
<b>Single Burn</b>					
500	270	9,218	20,322	8,308	18,316
400	216	9,463	20,863	8,545	18,838
300	162	9,672	21,324	8,744	19,278
200	108	9,842	21,698	8,905	19,633

**Notes:**  
 Launch Site: VAFB SLC-3E  
 Payload Fairing: EPF  
 PFJ at 3-sigma qV ≤ 1,135 W/m<sup>2</sup> (360 BTU/ft<sup>2</sup>-hr)  
 Park Orbit Perigee Altitude ≥ 167 km (90 nmi)  
 Confidence Level: 2.33 Sigma GCS

Figure 2.6.6-1c: Atlas V 421 Low Earth Orbit Performance — VAFB

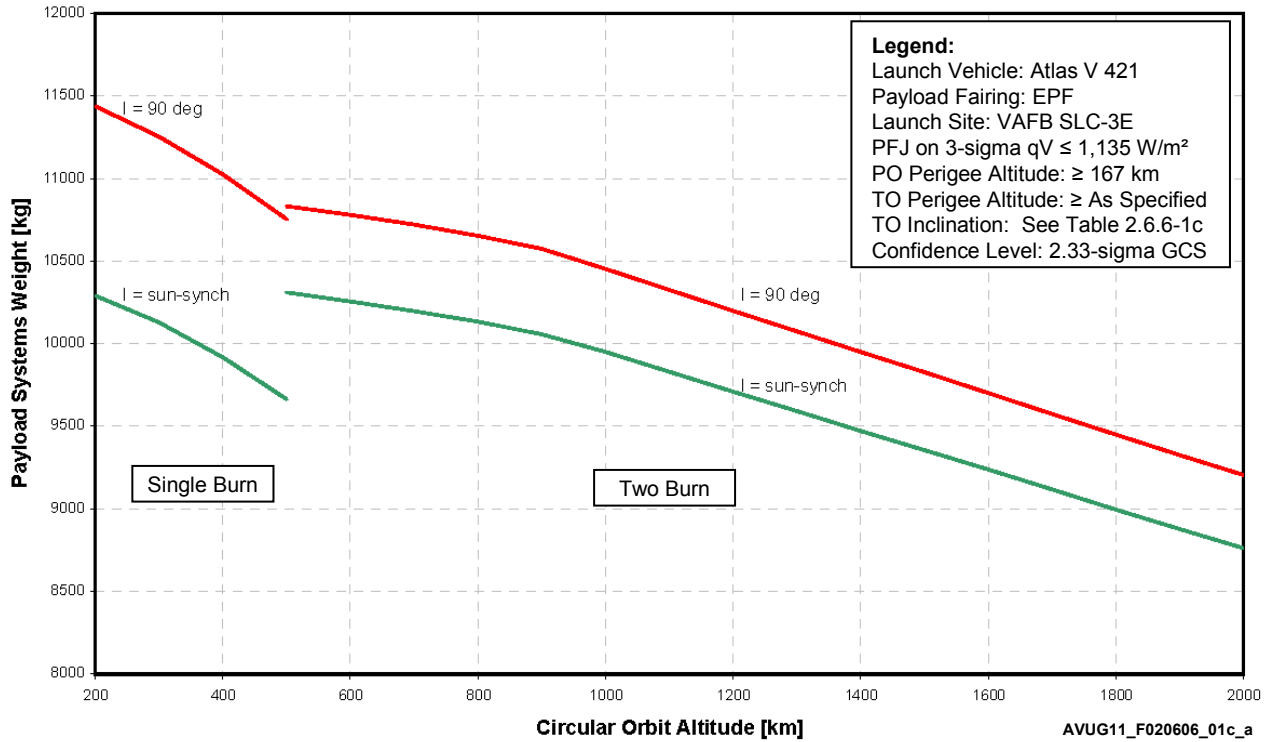


Table 2.6.6-1c: Atlas V 421 Low Earth Orbit Performance — PSW vs Altitude (VAFB)

Atlas V 421 LEO — VAFB					
Circular Orbit		Payload Systems Weight			
Altitude		I = 90 deg		Sun-Synch	
[km]	[nmi]	[kg]	[lb]	[kg]	[lb]
<b>Two Burn</b>					
2,000	1,080	9,203	20,290	8,759	19,311
1,900	1,026	9,324	20,557	8,876	19,568
1,800	972	9,448	20,829	8,995	19,830
1,700	918	9,573	21,105	9,116	20,097
1,600	864	9,700	21,384	9,237	20,365
1,500	810	9,826	21,663	9,354	20,622
1,400	756	9,949	21,934	9,471	20,880
1,300	702	10,074	22,208	9,589	21,141
1,200	648	10,199	22,484	9,709	21,404
1,100	594	10,324	22,761	9,829	21,669
1,000	540	10,450	23,039	9,949	21,933
900	486	10,574	23,312	10,056	22,170
800	432	10,653	23,486	10,132	22,336
700	378	10,719	23,632	10,197	22,479
600	324	10,778	23,762	10,255	22,610
500	270	10,831	23,878	10,309	22,727
<b>Single Burn</b>					
500	270	10,752	23,705	9,663	21,302
400	216	11,024	24,303	9,915	21,859
300	162	11,253	24,808	10,127	22,326
200	108	11,437	25,215	10,290	22,687

**Notes:**  
 Launch Site: VAFB SLC-3E  
 Payload Fairing: EPF  
 PFJ at 3-sigma qV ≤ 1,135 W/m<sup>2</sup> (360 BTU/ft<sup>2</sup>-hr)  
 Park Orbit Perigee Altitude ≥ 167 km (90 nmi)  
 Confidence Level: 2.33 Sigma GCS

Figure 2.6.6-1d: Atlas V 431 Low Earth Orbit Performance — VAFB

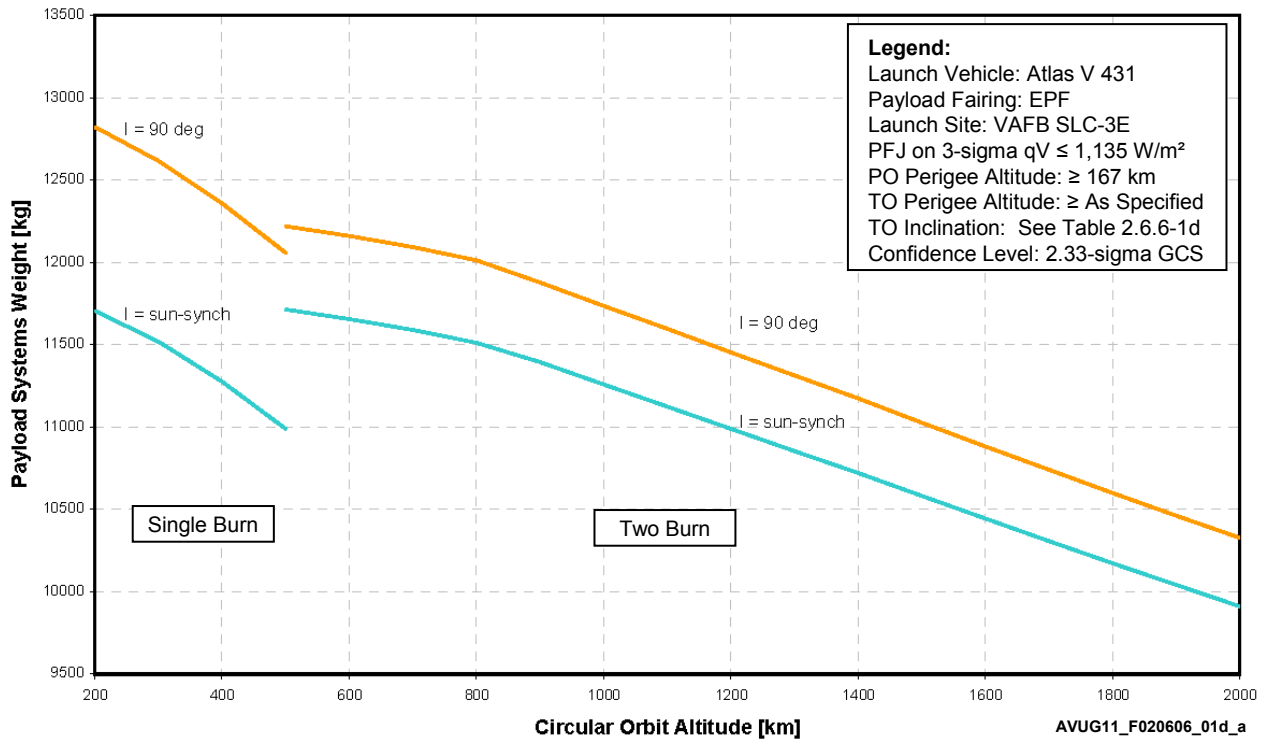




Table 2.6.6-1d: Atlas V 431 Low Earth Orbit Performance — PSW vs Altitude (VAFB)

Atlas V 431 LEO — VAFB					
Circular Orbit		Payload Systems Weight			
Altitude		I = 90 deg		Sun-Synch	
[km]	[nmi]	[kg]	[lb]	[kg]	[lb]
<b>Two Burn</b>					
2,000	1,080	10,325	22,763	9,909	21,847
1,900	1,026	10,461	23,062	10,039	22,133
1,800	972	10,598	23,366	10,172	22,425
1,700	918	10,739	23,675	10,306	22,721
1,600	864	10,881	23,988	10,443	23,022
1,500	810	11,025	24,307	10,581	23,327
1,400	756	11,171	24,629	10,719	23,631
1,300	702	11,312	24,939	10,853	23,926
1,200	648	11,452	25,247	10,987	24,222
1,100	594	11,594	25,560	11,122	24,520
1,000	540	11,735	25,871	11,257	24,818
900	486	11,876	26,183	11,391	25,114
800	432	12,011	26,480	11,511	25,376
700	378	12,092	26,658	11,588	25,547
600	324	12,159	26,807	11,654	25,694
500	270	12,218	26,937	11,713	25,823
<b>Single Burn</b>					
500	270	12,056	26,579	10,987	24,222
400	216	12,358	27,244	11,274	24,854
300	162	12,613	27,808	11,516	25,388
200	108	12,820	28,263	11,704	25,803

**Notes:**  
 Launch Site: VAFB SLC-3E  
 Payload Fairing: EPF  
 PFJ at 3-sigma qV ≤ 1,135 W/m<sup>2</sup> (360 BTU/ft<sup>2</sup>-hr)  
 Park Orbit Perigee Altitude ≥ 167 km (90 nmi)  
 Confidence Level: 2.33 Sigma GCS

Figure 2.6.6-2: Atlas V 501-551 Low Earth Orbit Performance — VAFB (90.0 deg)

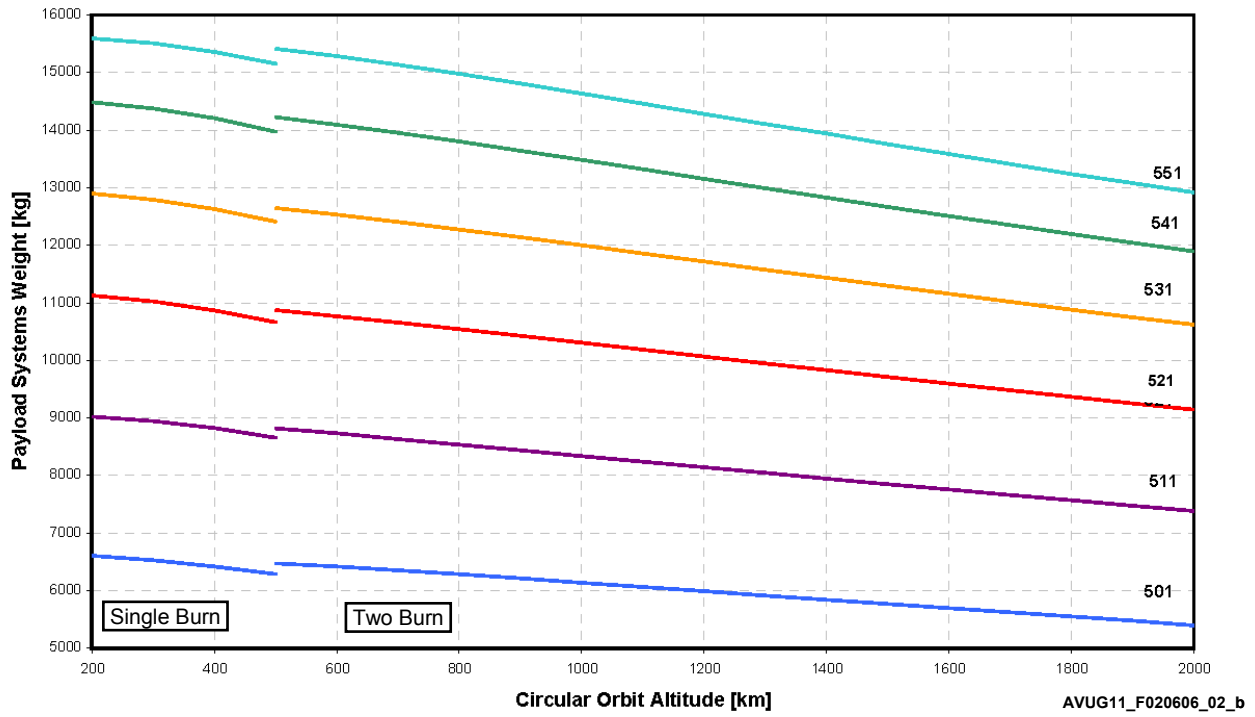


Figure 2.6.6-2-1: Atlas V 501-551 Low Earth Orbit Performance — VAFB (Sun-sync)

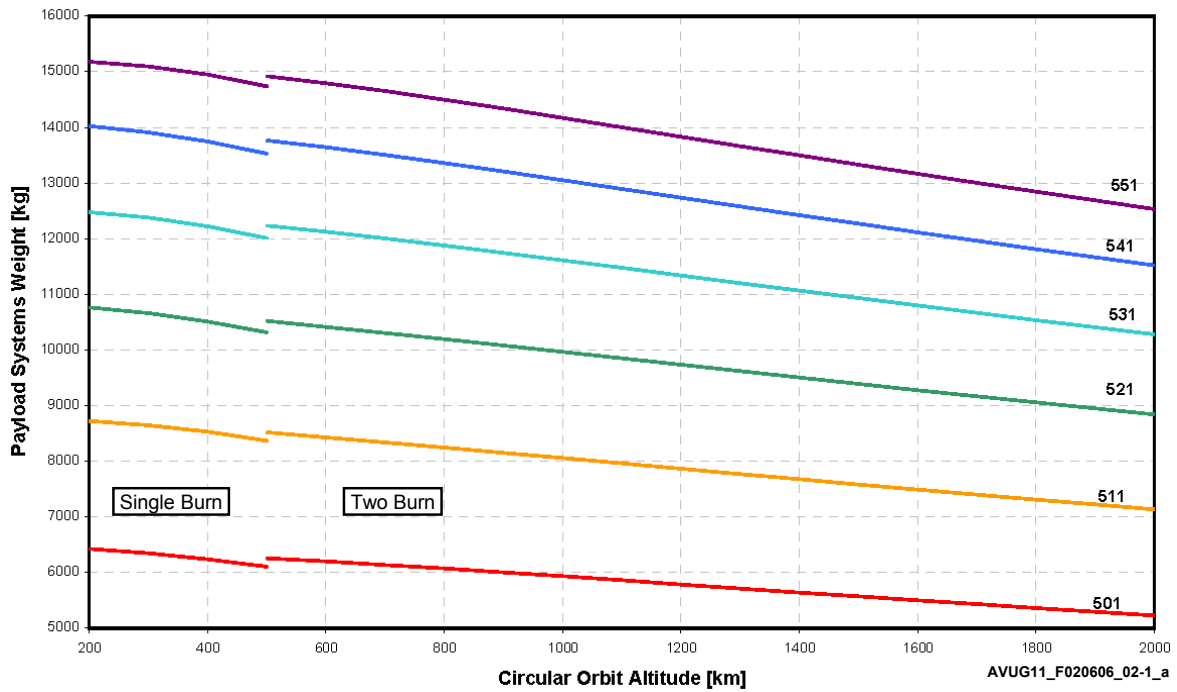


Figure 2.6.6-2a: Atlas V 501 Low Earth Orbit Performance — VAFB

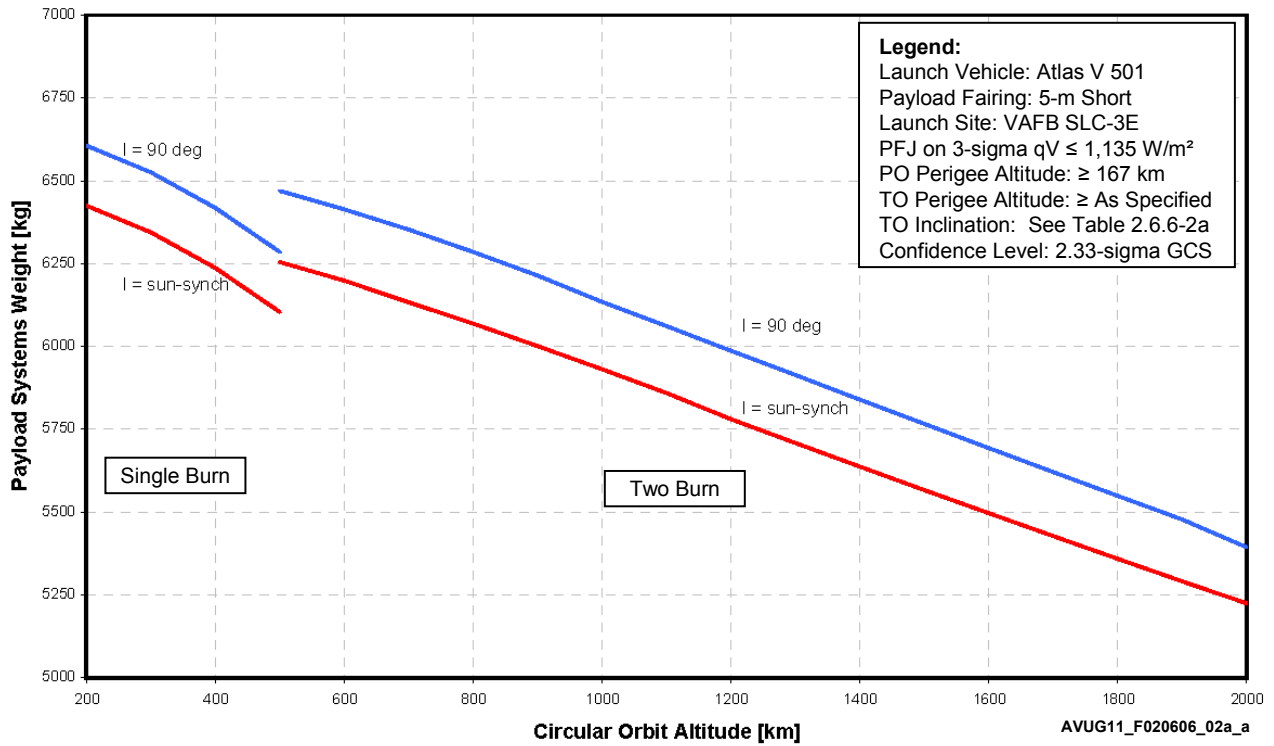


Table 2.6.6-2a: Atlas V 501 Low Earth Orbit Performance — PSW vs Altitude

Atlas V 501 LEO — VAFB					
Circular Orbit		Payload Systems Weight			
Altitude		I = 90 deg		Sun-Synch	
[km]	[nmi]	[kg]	[lb]	[kg]	[lb]
<b>Two Burn</b>					
2,000	1,080	5,393	11,890	5,224	11,517
1,900	1,026	5,477	12,076	5,291	11,664
1,800	972	5,549	12,232	5,358	11,813
1,700	918	5,620	12,390	5,427	11,964
1,600	864	5,693	12,550	5,496	12,117
1,500	810	5,765	12,710	5,566	12,271
1,400	756	5,839	12,872	5,637	12,427
1,300	702	5,913	13,035	5,708	12,584
1,200	648	5,987	13,199	5,780	12,742
1,100	594	6,060	13,361	5,859	12,916
1,000	540	6,133	13,522	5,930	13,074
900	486	6,213	13,698	6,001	13,229
800	432	6,285	13,856	6,068	13,378
700	378	6,352	14,004	6,132	13,519
600	324	6,414	14,140	6,198	13,665
500	270	6,469	14,263	6,253	13,786
<b>Single Burn</b>					
500	270	6,285	13,855	6,103	13,455
400	216	6,418	14,149	6,236	13,749
300	162	6,524	14,384	6,343	13,984
200	108	6,606	14,563	6,424	14,163

**Notes:**  
 Launch Site: VAFB SLC-3E  
 Payload Fairing: 5-m Short  
 PFJ at 3-sigma qV ≤ 1,135 W/m<sup>2</sup> (360 BTU/ft<sup>2</sup>-hr)  
 Park Orbit Perigee Altitude ≥ 167 km (90 nmi)  
 Confidence Level: 2.33 Sigma GCS

Figure 2.6.6-2b: Atlas V 511 Low Earth Orbit Performance — VAFB

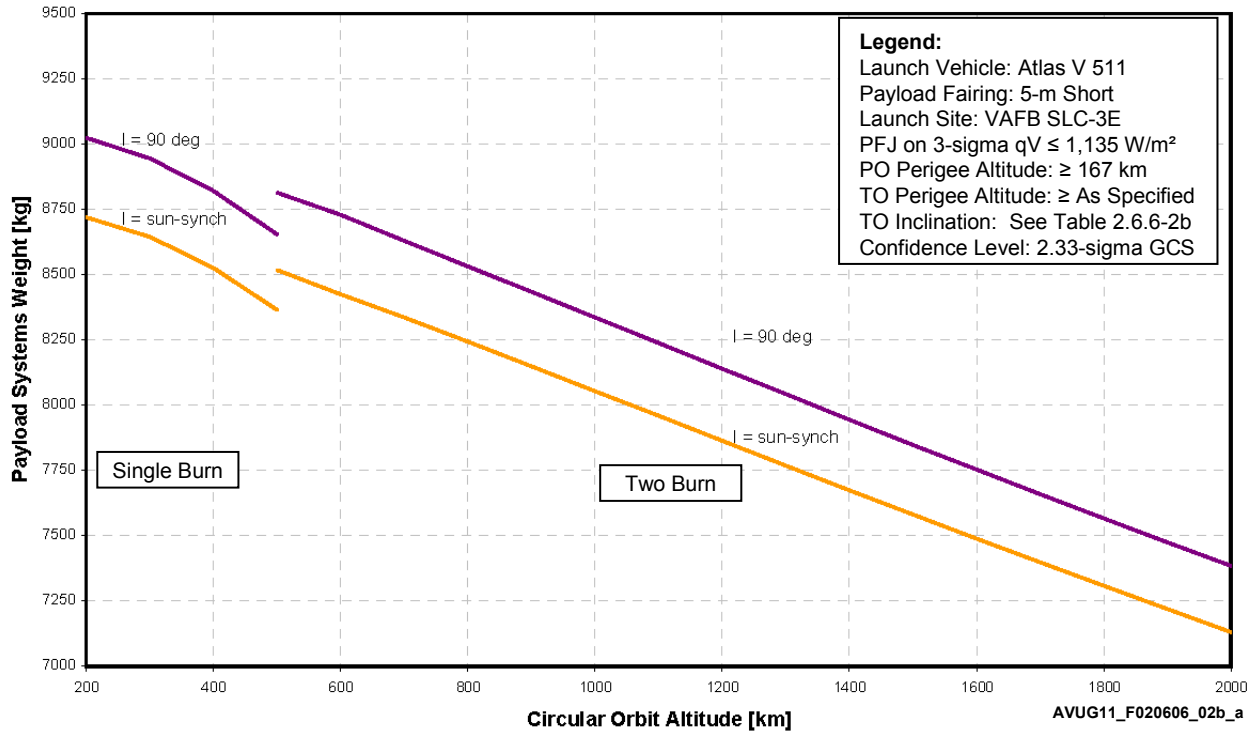


Table 2.6.6-2b: Atlas V 511 Low Earth Orbit Performance — PSW vs Altitude

Atlas V 511 LEO — VAFB					
Circular Orbit		Payload Systems Weight			
Altitude		I = 90 deg		Sun-Synch	
[km]	[nmi]	[kg]	[lb]	[kg]	[lb]
<b>Two Burn</b>					
2,000	1,080	7,383	16,278	7,130	15,720
1,900	1,026	7,474	16,476	7,218	15,913
1,800	972	7,565	16,677	7,307	16,108
1,700	918	7,658	16,882	7,397	16,307
1,600	864	7,752	17,090	7,487	16,507
1,500	810	7,847	17,300	7,580	16,710
1,400	756	7,944	17,513	7,673	16,917
1,300	702	8,041	17,728	7,768	17,125
1,200	648	8,139	17,944	7,862	17,334
1,100	594	8,238	18,161	7,958	17,544
1,000	540	8,336	18,377	8,053	17,754
900	486	8,433	18,593	8,148	17,963
800	432	8,531	18,807	8,242	18,171
700	378	8,629	19,023	8,335	18,376
600	324	8,728	19,243	8,424	18,572
500	270	8,814	19,431	8,517	18,776
<b>Single Burn</b>					
500	270	8,653	19,078	8,364	18,440
400	216	8,821	19,446	8,526	18,796
300	162	8,944	19,718	8,644	19,056
200	108	9,023	19,892	8,719	19,223

**Notes:**  
 Launch Site: VAFB SLC-3E  
 Payload Fairing: 5-m Short  
 PFJ at 3-sigma  $qV \leq 1,135 \text{ W/m}^2$  (360 BTU/ft<sup>2</sup>-hr)  
 Park Orbit Perigee Altitude  $\geq 167 \text{ km}$  (90 nmi)  
 Confidence Level: 2.33 Sigma GCS

Figure 2.6.6-2c: Atlas V 521 Low Earth Orbit Performance — VAFB

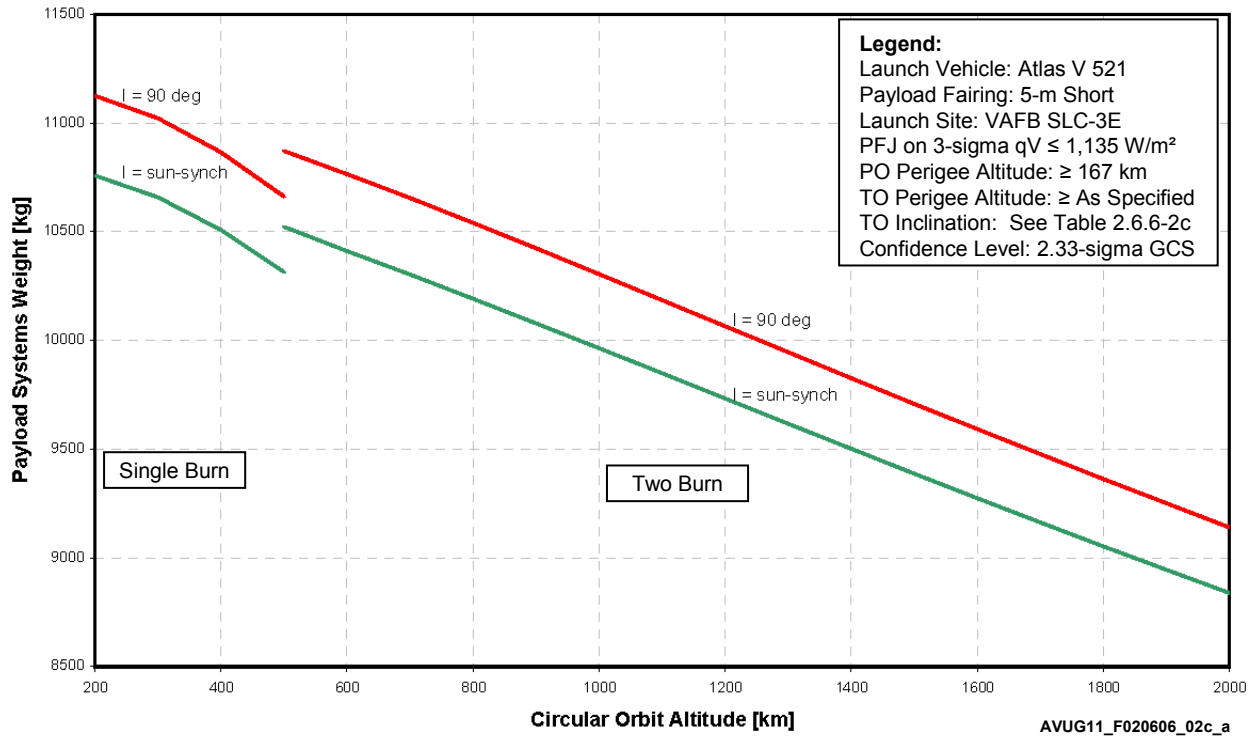




Table 2.6.6-2c: Atlas V 521 Low Earth Orbit Performance — PSW vs Altitude

Atlas V 521 LEO — VAFB					
Circular Orbit		Payload Systems Weight			
Altitude		I = 90 deg		Sun-Synch	
[km]	[nmi]	[kg]	[lb]	[kg]	[lb]
<b>Two Burn</b>					
2,000	1,080	9,139	20,147	8,837	19,482
1,900	1,026	9,250	20,392	8,944	19,718
1,800	972	9,362	20,640	9,052	19,957
1,700	918	9,476	20,891	9,162	20,200
1,600	864	9,591	21,145	9,274	20,445
1,500	810	9,708	21,403	9,387	20,695
1,400	756	9,826	21,662	9,501	20,946
1,300	702	9,945	21,925	9,616	21,200
1,200	648	10,065	22,189	9,732	21,454
1,100	594	10,185	22,453	9,848	21,710
1,000	540	10,304	22,717	9,963	21,965
900	486	10,423	22,979	10,078	22,218
800	432	10,540	23,236	10,191	22,467
700	378	10,655	23,489	10,303	22,713
600	324	10,765	23,733	10,410	22,950
500	270	10,870	23,965	10,521	23,195
<b>Single Burn</b>					
500	270	10,661	23,505	10,313	22,737
400	216	10,865	23,953	10,508	23,166
300	162	11,021	24,297	10,658	23,496
200	108	11,125	24,527	10,758	23,717

**Notes:**  
 Launch Site: VAFB SLC-3E  
 Payload Fairing: 5-m Short  
 PFJ at 3-sigma qV ≤ 1,135 W/m<sup>2</sup> (360 BTU/ft<sup>2</sup>-hr)  
 Park Orbit Perigee Altitude ≥ 167 km (90 nmi)  
 Confidence Level: 2.33 Sigma GCS

Figure 2.6.6-2d: Atlas V 531 Low Earth Orbit Performance — VAFB

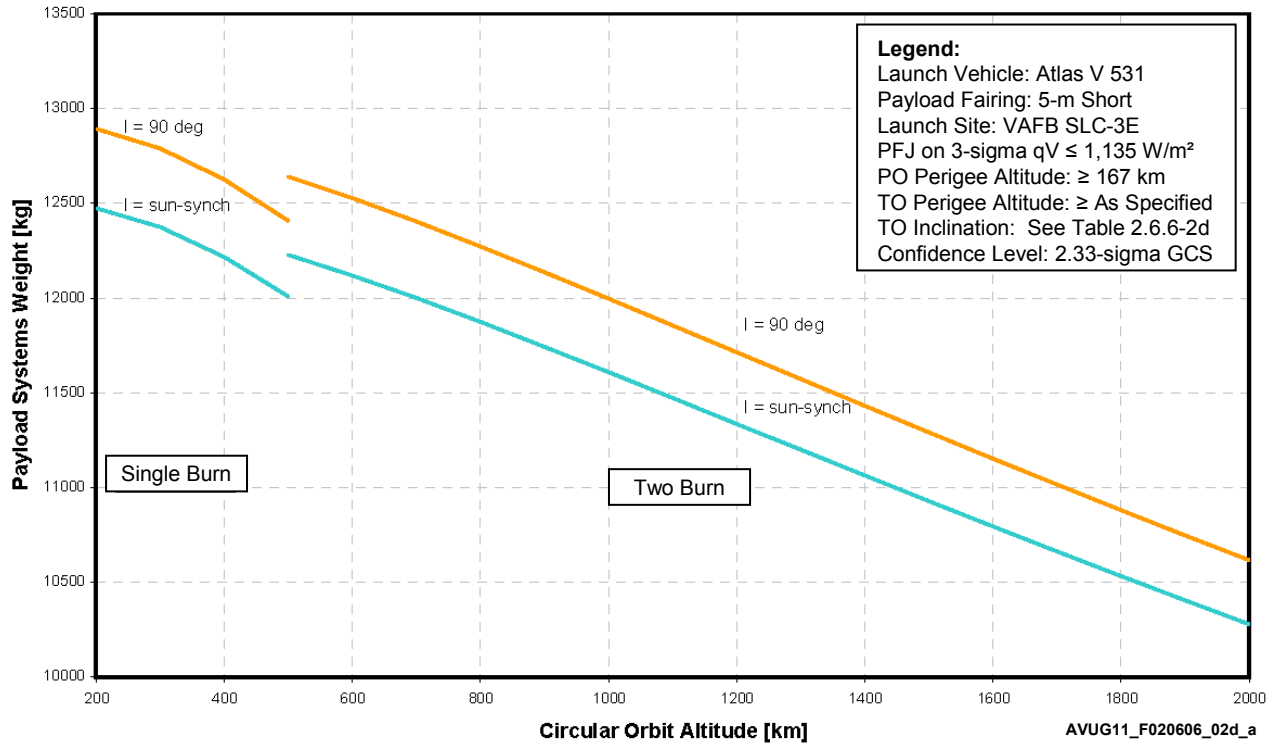


Table 2.6.6-2d: Atlas V 531 Low Earth Orbit Performance — PSW vs Altitude

Atlas V 531 LEO — VAFB					
Circular Orbit		Payload Systems Weight			
Altitude		I = 90 deg		Sun-Synch	
[km]	[nmi]	[kg]	[lb]	[kg]	[lb]
<b>Two Burn</b>					
2,000	1,080	10,615	23,403	10,276	22,655
1,900	1,026	10,746	23,691	10,403	22,934
1,800	972	10,879	23,985	10,531	23,217
1,700	918	11,015	24,283	10,661	23,504
1,600	864	11,151	24,585	10,794	23,796
1,500	810	11,290	24,891	10,927	24,091
1,400	756	11,431	25,200	11,062	24,389
1,300	702	11,571	25,511	11,198	24,688
1,200	648	11,713	25,823	11,335	24,989
1,100	594	11,855	26,136	11,472	25,291
1,000	540	11,996	26,446	11,608	25,590
900	486	12,135	26,754	11,742	25,886
800	432	12,271	27,054	11,873	26,175
700	378	12,403	27,343	12,000	26,455
600	324	12,527	27,617	12,119	26,718
500	270	12,640	27,866	12,228	26,957
<b>Single Burn</b>					
500	270	12,406	27,352	12,007	26,472
400	216	12,625	27,833	12,215	26,930
300	162	12,790	28,197	12,374	27,280
200	108	12,893	28,424	12,473	27,498

**Notes:**  
 Launch Site: VAFB SLC-3E  
 Payload Fairing: 5-m Short  
 PFJ at 3-sigma qV ≤ 1,135 W/m<sup>2</sup> (360 BTU/ft<sup>2</sup>-hr)  
 Park Orbit Perigee Altitude ≥ 167 km (90 nmi)  
 Confidence Level: 2.33 Sigma GCS

Figure 2.6.6-2e: Atlas V 541 Low Earth Orbit Performance — VAFB

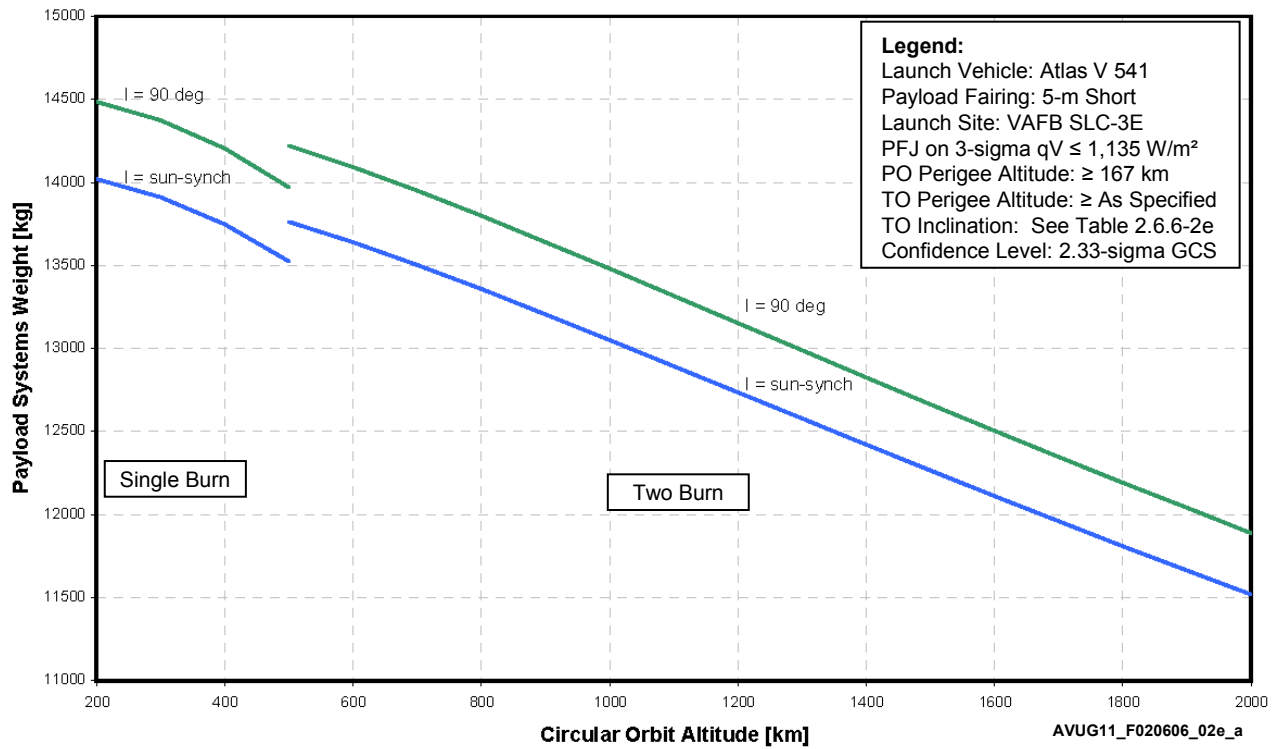


Table 2.6.6-2e: Atlas V 541 Low Earth Orbit Performance — PSW vs Altitude

Atlas V 541 LEO — VAFB					
Circular Orbit		Payload Systems Weight			
Altitude		I = 90 deg		Sun-Synch	
[km]	[nmi]	[kg]	[lb]	[kg]	[lb]
<b>Two Burn</b>					
2,000	1,080	11,888	26,209	11,517	25,390
1,900	1,026	12,039	26,542	11,662	25,710
1,800	972	12,191	26,877	11,809	26,034
1,700	918	12,346	27,219	11,958	26,364
1,600	864	12,503	27,564	12,110	26,698
1,500	810	12,663	27,916	12,264	27,038
1,400	756	12,825	28,273	12,420	27,381
1,300	702	12,988	28,633	12,577	27,727
1,200	648	13,152	28,994	12,734	28,074
1,100	594	13,315	29,355	12,892	28,422
1,000	540	13,479	29,716	13,049	28,769
900	486	13,640	30,071	13,205	29,111
800	432	13,798	30,419	13,356	29,445
700	378	13,949	30,753	13,502	29,766
600	324	14,092	31,067	13,638	30,067
500	270	14,220	31,350	13,761	30,338
<b>Single Burn</b>					
500	270	13,969	30,797	13,524	29,816
400	216	14,203	31,312	13,746	30,304
300	162	14,372	31,685	13,909	30,665
200	108	14,484	31,932	14,019	30,908

**Notes:**  
 Launch Site: VAFB SLC-3E  
 Payload Fairing: 5-m Short  
 PFJ at 3-sigma qV ≤ 1,135 W/m<sup>2</sup> (360 BTU/ft<sup>2</sup>-hr)  
 Park Orbit Perigee Altitude ≥ 167 km (90 nmi)  
 Confidence Level: 2.33 Sigma GCS

Figure 2.6.6-2f: Atlas V 551 Low Earth Orbit Performance — VAFB

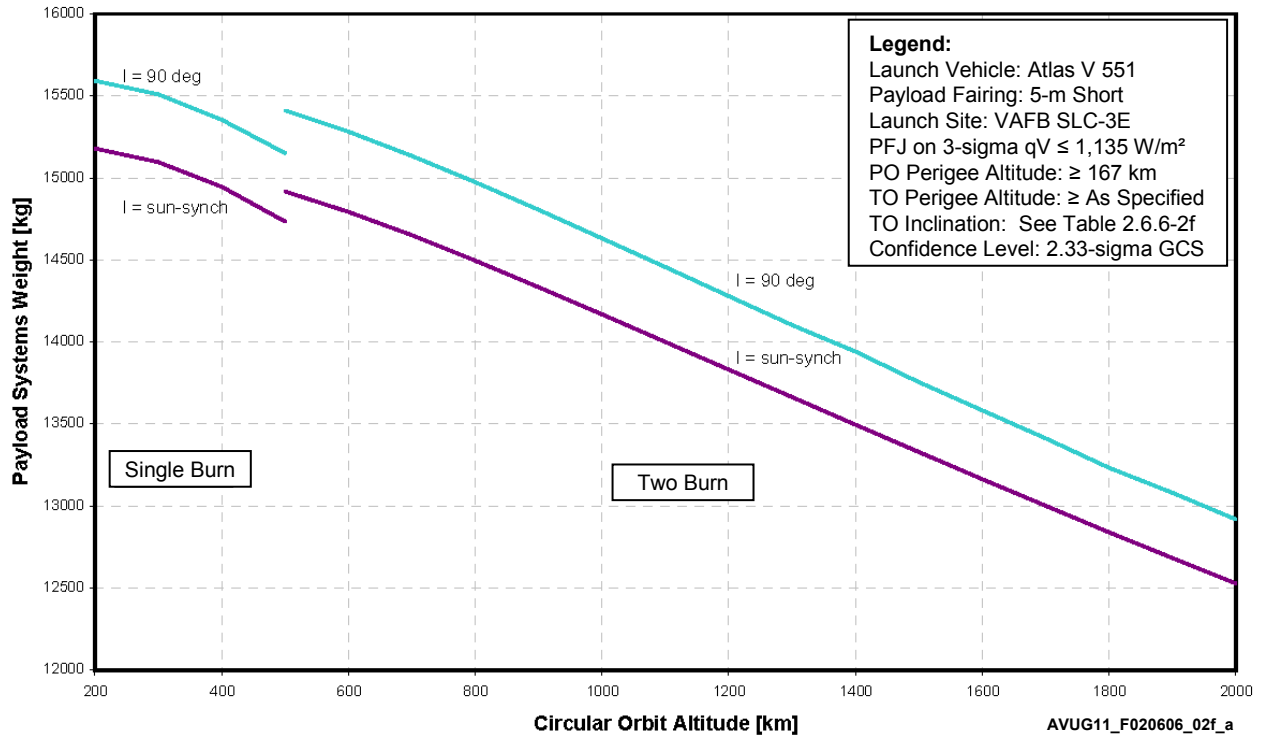


Table 2.6.6-2f: Atlas V 551 Low Earth Orbit Performance — PSW vs Altitude

Atlas V 551 LEO — VAFB					
Circular Orbit		Payload Systems Weight			
Altitude		I = 90 deg		Sun-Synch	
[km]	[nmi]	[kg]	[lb]	[kg]	[lb]
<b>Two Burn</b>					
2,000	1,080	12,917	28,477	12,526	27,614
1,900	1,026	13,079	28,833	12,681	27,958
1,800	972	13,231	29,170	12,839	28,306
1,700	918	13,411	29,566	13,000	28,659
1,600	864	13,581	29,941	13,162	29,018
1,500	810	13,753	30,321	13,327	29,382
1,400	756	13,940	30,731	13,494	29,749
1,300	702	14,102	31,090	13,661	30,118
1,200	648	14,279	31,480	13,830	30,490
1,100	594	14,456	31,869	14,000	30,864
1,000	540	14,631	32,256	14,168	31,235
900	486	14,804	32,637	14,334	31,601
800	432	14,972	33,009	14,495	31,956
700	378	15,133	33,363	14,649	32,296
600	324	15,282	33,691	14,792	32,611
500	270	15,410	33,972	14,917	32,887
<b>Single Burn</b>					
500	270	15,151	33,403	14,734	32,482
400	216	15,352	33,846	14,945	32,949
300	162	15,508	34,189	15,095	33,279
200	108	15,591	34,373	15,179	33,464

**Notes:**  
 Launch Site: VAFB SLC-3E  
 Payload Fairing: 5-m Short  
 PFJ at 3-sigma qV ≤ 1,135 W/m<sup>2</sup> (360 BTU/ft<sup>2</sup>-hr)  
 Park Orbit Perigee Altitude ≥ 167 km (90 nmi)  
 Confidence Level: 2.33 Sigma GCS

Intentionally Left Blank



### 3. ENVIRONMENTS

This section describes the Atlas V prelaunch and flight environments to which the spacecraft (SC) is exposed. It details SC environmental data for Atlas V launch vehicles (LVs) for Space Launch Complex 41 (SLC-41) at Cape Canaveral Air Force Station (CCAFS), FL, and for Space Launch Complex 3-East (SLC-3E) facility at Vandenberg Air Force Base (VAFB), CA.

Section 3.1 describes prelaunch environments, Section 3.2 describes launch and flight environments, and Section 3.3 describes spacecraft test compatibility requirements.

#### 3.1 PRELAUNCH ENVIRONMENTS

##### 3.1.1 Thermal

The SC thermal environment is maintained during ground transport and hoist. The encapsulated SC thermal environment is controlled after it is mated to the LV and during prelaunch activity, as described in the following paragraphs.

**Payload Processing Facility** — Payload Processing Facility (PPF) environments in the SC processing areas at Astrotech/CCAFS are controlled at 21-27 °C (70-80 °F) and 50 ± 5% relative humidity. Portable air conditioning units are available to further cool test equipment or SC components as required.

**Ground Transport From PPF to Launch Site** — During ground transport from the PPF to the Vertical Integration Facility (VIF), the temperature within the Atlas V 4-m Payload Fairing (PLF) remains between 4-30 °C (40-86 °F), with conditioning provided by an air Environmental Control System (ECS) or a Gaseous Nitrogen (GN<sub>2</sub>) purge. If required, the ECS can maintain air temperatures between 10-25 °C (50-77 °F). The maximum dew point temperature is -37 °C (-35 °F) for GN<sub>2</sub> and 4.4 °C (40 °F) for air. At VAFB SLC-3E, the transporter environmental control unit maintains temperature between 10-27 °C (50-80 °F) at a maximum dew point temperature of 4.4 °C (40 °F). A GN<sub>2</sub> backup system is available at VAFB.

The air temperature within the Atlas V 5-m payload fairing is maintained between 4-30 °C (40-86 °F) during transport from the PPF to the VIF. This is accomplished with a mobile environmental control unit that guarantees a maximum dew point temperature of 4.4 °C (40 °F).

**Hoisting Operations** — During hoisting operations at SLC-41 and SLC-3E, the encapsulated SC is purged with dry GN<sub>2</sub> with a maximum dew point of -37 °C (-35 °F).

**Post-Spacecraft Mate to Centaur** — After SC mating to the LV, gas conditioning is provided to the PLF using analysis-derived inlet temperatures, flow rate, and dew point. Air with a maximum dew point of 4.4 °C (40 °F) is used until approximately 4 hours before launch at SLC-41 and approximately 3 hours before launch at SLC-3E, after which GN<sub>2</sub> with a maximum dew point of -37 °C (-35 °F) is used. Table 3.1.1-1 summarizes prelaunch gas conditioning temperature capabilities for the nominal Atlas V 400 and 500 series configurations at SLC-41 and SLC-3E. Mission-unique arrangements for dedicated purges of specific components can be provided.

The ECS flow to the payload compartment is supplied through a ground/airborne disconnect on the PLF and is controlled by primary and backup environmental control units. These units provide conditioned air or GN<sub>2</sub> to the specifications in Table 3.1.1-2. Figure 3.1.1-1 shows the general gas-conditioning layout for the 4-m PLF configuration and Figure 3.1.1-2 shows the general gas-conditioning layout for 5-m PLF configuration.

Internal ducting in the 4-m PLF directs the gas upward to prevent direct impingement on the SC. The conditioning gas is vented to the atmosphere through one-way flapper doors in the aft end of the PLF. The PLF air distribution system will provide a maximum airflow velocity in all directions of no more than 9.75 mps (32 fps) for the Atlas V 400 series and 10.67 mps (35 fps) for the Atlas V 500 series. There will be localized areas of higher flow velocity at, near, or associated with the air conditioning outlet. Maximum airflow

velocities correspond to maximum inlet mass flow rates. Reduced flow velocities are achievable using lower inlet mass flow rates. If required, a computational fluid dynamics analysis can be performed to verify mission-unique gas impingement velocity limits.

The conditioned air is typically delivered near the top of the PLF and the flow can be divided so up to 40% or more of the gas flow is directed to the base of the payload compartment when required for SC battery cooling or other ground operations.

Mission-unique arrangements for dedicated grade B or C GN<sub>2</sub> purges with a maximum dew point of -37.2 °C

**Table 3.1.1-1: Atlas V Gas Conditioning Capabilities**

			Temperature Range Inside Payload Fairing**	
			Atlas V 400 Series	Atlas V 500 Series
Location	Inlet Temperature Capability*	Inlet Flow Rate Capability, kg/min (lb/min)	LPF, EPF & XEPF	5-m Short, Medium & Long
Inside VIF or MST	10-29 °C (50-85 °F)	Atlas V 400 Series: 22.7-72.6 (50-160)	6-20 °C (43-68 °F)	6-20 °C (43-68 °F)
		Atlas V 500 Series: 22.7-136.2 (50-300)		
Roll from VIF to launch pad (SLC-41 only)	10-29 °C (50-85 °F)	Atlas V 400 Series: 22.7-72.6 (50-160)	6-26 °C (43-79 °F)	6-23 °C (43-73 °F)
		Atlas V 500 Series: 22.7-136.2 (50-300)		
Outside VIF or MST	10-29 °C (50-85 °F)	Atlas V 400 Series: 22.7-72.6 (50-160)	6-21 °C (43-70 °F)	6-21 °C (43-70 °F)
		Atlas V 500 Series: 22.7-136.2 (50-300)		
<b>Notes:</b> *Inlet temperatures are determined by analysis to meet SC internal PLF gas temperature and relative humidity requirements. **Internal PLF temperatures are <u>not</u> selectable within these ranges. SCs must be compatible with the full ranges. Ranges shown assume a 72.6 kg/min (160 lb/min) for 4-m ECS flow rate; 136.2 kg/min (300 lb/min) for 5-m ECS flow rate.				

**Table 3.1.1-2: Conditioned Air/GN<sub>2</sub> Characteristics**

Parameter	Description
	<b>Atlas V (400/500 Series)</b>
Cleanliness	• Class 5,000 per FED-STD-209D
Inlet Temperature	• Setpoint from 10-29 °C (50-85°F) • 10-21 °C (50-70 °F) for Sensitive Operations
Inlet Temperature Control	• ±1.1 °C (±2 °F)
Filtration	• 99.97% HEPA Not Dioctyl Phthalate (DOP) Tested
Flow Rate	• <b>Atlas V 400 Series:</b> 22.7-72.6 kg/min ± 2.3 kg/min (50-160 lb/min ±5 lb/min) • <b>Atlas V 500 Series:</b> 22.7-136.2 kg/min ± 5.7 kg/min (50-300 lb/min ±12.5 lb/min)
Dew point (Maximum)	• 20-50% RH Air • 35-50% RH (Sensitive Operation) Air • -37.2 °C (-35 °F) GN <sub>2</sub>

Figure 3.1.1-1: 4-m PLF Environmental Conditioning System

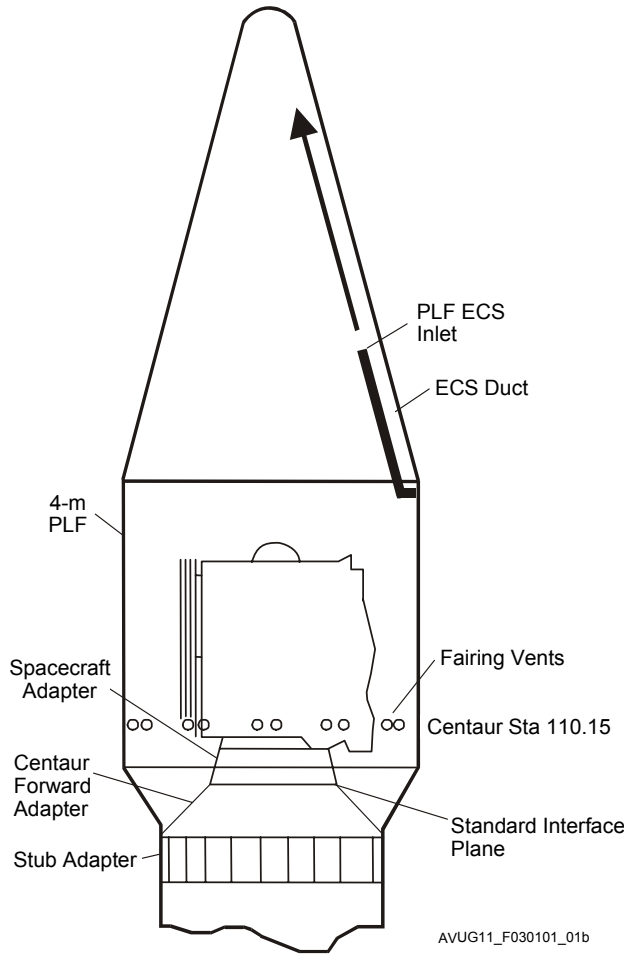
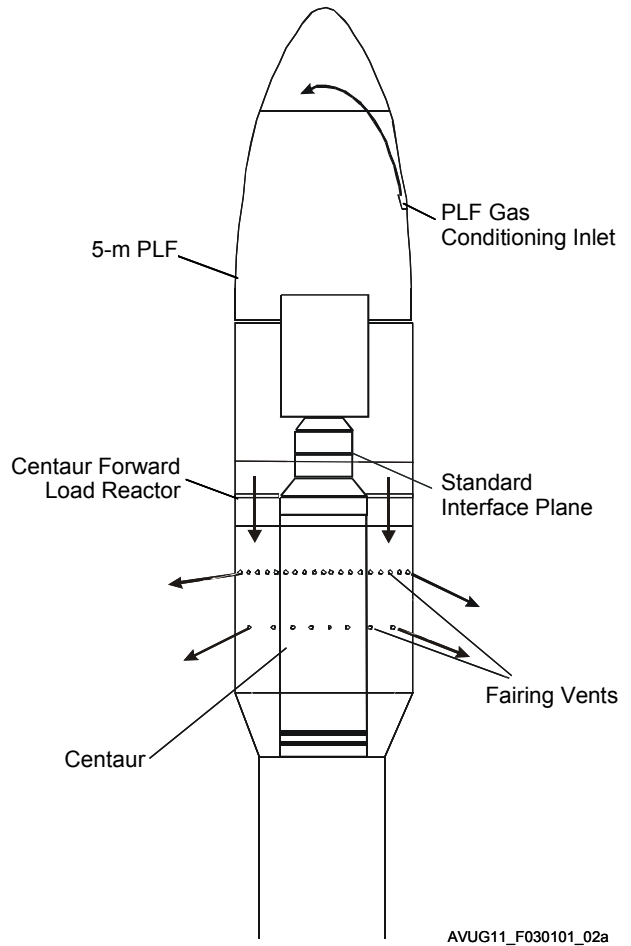


Figure 3.1.1-2: 5-m PLF Environmental Conditioning System



(-35°F) of specific SC components can be provided at up to 14.2 standard m<sup>3</sup>/hr (500 standard ft<sup>3</sup>/hr).

### 3.1.2 Electromagnetic Compatibility

The Electromagnetic (EM) environment needs to be evaluated by both the LV and SC to ensure Electromagnetic Compatibility (EMC) for each launch. The launch services customer provides all SC data and reports necessary to support EMC verification (See Section 4.5) used for this purpose.

#### 3.1.2.1 Launch Vehicle Intentional RF Emissions

LV intentional transmissions are limited to the S-band telemetry transmitters (for operation with the Tracking/Data Relay Satellite System and GPS Metric Tracking System), S-band video, and the C-band beacon transponder.

LV transmitter and receiver characteristics for the Atlas V 400 and 500 series LVs appear in Tables 3.1.2.1-1 through 3.1.2.1-6.

Table 3.1.2.1-1: Atlas V 400 Series C-Band Transponder and RF Characteristics

<b>TRANSMITTER</b>			
p/n 58-03240-1			
Frequency		5765	MHz
Frequency Stability		±3	MHz
Bandwidth		6	MHz
Pulse Modulation			
Pulse Frequency		2600	pps (max ops)
		1000	pps (nominal ops)
Pulsewidth		0.5 (±0.1)	microseconds
Fixed Delay Setting		2.5 (±0.1)	microseconds
Output Power (peak)		700	watts (max)
<b>RECEIVER</b>			
p/n 58-03240-1			
Frequency		5690	MHz
Stability		±3	MHz
3 dB Bandwidth		11 (±3)	MHz
Sensitivity		-67	dBm minimum
<b>ANTENNA SYSTEM</b>		Clock Angle Pattern Cut (0 to 360°) in 10° (theta) bands.	
p/n 58-03220-3		(includes 3 dB power split)	
<u>Type</u>			
Slot	Theta (deg)	Omni, with PLF Gain dBi Max.	Omni, no PLF Gain dBi Max.
RHC Polarized	80 to 90	-14.63	-2.50
	70 to 80	-10.91	-1.03
<u>Locations</u>	60 to 70	-6.89	+0.21
Centaur Station, 97.8 inches	50 to 60	+0.65	+0.54
Centaur Clock Angle, 177° and 357°	40 to 50	+1.95	+0.44
	30 to 40	+2.09	+1.23
	20 to 30	+2.42	+1.53
	10 to 20	+3.06	+2.24
	0 to 10	+3.45	+2.95
	-10 to 0	+2.83	+2.95
	-20 to -10	+1.99	+2.03
	-30 to -20	+1.37	+0.62
	-40 to -30	+0.16	-0.06
<b>Vehicle Min. RF Loss</b>	-50 to -40	-1.19	-0.94
1.6 dB, with PLF	-60 to -50	-1.52	-1.30
1.6 dB, no PLF	-70 to -60	-2.58	-1.99
	-80 to -70	-2.41	-2.78
	-90 to -80	-3.56	-3.49

Table 3.1.2.1-2: Atlas V 400 Series S-Band Transmitter and RF Characteristics

<b>TRANSMITTER</b>				
p/n 55-03053-3				
Frequency		2211	MHz	
Frequency Stability		4.4	kHz	
Bandwidth		±4	MHz	
Modulation		BPSK/QPSK		
Telemetry Rate (NRZ-M)		1024 or 256	kbps I - Channel	
Forward Error Correction		Convolutional	Rate 1/2, k=7	
		3200 or 200	kbps Q - Channel	
Output Power:				
Single Port		26.0	watt minimum	
		45.0	watt maximum	
Dual Port		11.6	watt minimum	
		25.4	watt maximum	
<b>ANTENNA SYSTEM</b>				
p/n 58-03220-3				
<u>Type</u>				
Slot	Theta (deg)	(includes 3 dB power split)		(no 3 dB power split)
RHC Polarized		Omni, with PLF Gain dBi Max.	Omni, no PLF Gain dBi Max.	Single Antenna, no PLF Gain dBi Max.
	80 to 90	-7.00	-5.83	-3.31
	70 to 80	-4.90	-2.76	-0.50
<u>Locations</u>	60 to 70	-4.01	-0.10	+1.56
Centaur Station, 97.8 inches	50 to 60	-0.07	+1.62	+3.48
Centaur Clock Angle, 177° and 357°	40 to 50	+1.99	+2.20	+4.64
	30 to 40	+2.38	+2.35	+5.09
	20 to 30	+3.73	+2.35	+5.09
	10 to 20	+3.11	+1.89	+4.80
	0 to 10	+1.91	+1.60	+4.66
	-10 to 0	+2.10	+1.51	+4.45
	-20 to -10	+1.82	+1.19	+4.24
	-30 to -20	+0.33	+0.75	+3.60
	-40 to -30	+0.33	+0.17	+2.67
	-50 to -40	-1.09	-1.38	+1.36
	-60 to -50	-1.16	-1.89	+0.58
<b>Vehicle Min. RF Loss</b>				
1.1 dB, with PLF	-70 to -60	-1.90	-2.45	+0.21
1.1 dB, no PLF	-80 to -70	-2.70	-2.02	-0.21
	-90 to -80	-2.70	-2.02	-0.69

Table 3.1.2.1-3: Atlas V 400 Flight Termination System Receiver and RF Characteristics

<b>RECEIVER</b>			
p/n 58-03230-1			
Frequency		421.0	MHz
Stability		±0.0005	% of 410.3 MHz
Bandwidth		0.180	MHz
Sensitivity		-107.0	dBm minimum
<b>ANTENNA SYSTEM</b>		Clock Angle Pattern Cut (0 to 360°) in 10° (theta) bands.	
p/n 58-03220-3		(includes 3 dB power split)	
<u>Type</u>			
Slot	Theta (deg)	Omni, with PLF Gain dBi Max.	Omni, no PLF Gain dBi Max.
Linear Vertical Polarized	80 to 90	-5.91	-2.96
	70 to 80	-4.81	-3.27
<u>Locations</u>	60 to 70	-5.37	-3.90
Centaur Station, 106.9 inches	50 to 60	-3.33	-2.50
	40 to 50	-2.00	-2.77
Centaur Clock Angle, 177° and 357°	30 to 40	-1.15	-2.84
	20 to 30	-1.15	-2.24
	10 to 20	-1.15	-2.09
	0 to 10	-3.15	-2.14
	-10 to 0	-5.20	-1.58
	-20 to -10	-4.00	-1.58
	-30 to -20	-3.56	-1.58
	-40 to -30	-2.88	-1.72
<b>Vehicle Min. RF Loss</b>	-50 to -40	-2.08	-2.44
1.4 dB, with PLF	-60 to -50	-1.63	-1.73
1.4 dB, no PLF	-70 to -60	-1.10	-1.27
	-80 to -70	-1.47	-1.61
	-90 to -80	-2.82	-2.50

Table 3.1.2.1-4: Atlas V 500 Series C-Band Transponder and RF Characteristics

<b>TRANSMITTER</b>			
p/n 58-03240-1			
Frequency		5765	MHz
Frequency Stability		±3	MHz
Bandwidth		6	MHz
Pulse Modulation			
Pulse Frequency		2600	pps (max ops)
		1000	pps (nominal ops)
Pulsewidth		0.5 (±0.1)	microseconds
Fixed Delay Setting		2.5 (±0.1)	microseconds
Output Power (peak)		700	watts (max)
<b>RECEIVER</b>			
p/n 58-03240-1			
Frequency		5690	MHz
Stability		±3	MHz
3 dB Bandwidth		11 (±3)	MHz
Sensitivity		-67	dBm minimum
<b>ANTENNA SYSTEM</b>		Clock Angle Pattern Cut (0 to 360°) in 10° (theta) bands.	
p/n 58-03220-3		(includes 3 dB power split)	
<u>Type</u>			
Slot	Theta (deg)	Omni, with PLF Gain dBi Max.	Omni, no PLF Gain dBi Max.
RHC Polarized	80 to 90	-3.17	-7.57
	70 to 80	-3.17	-1.75
<u>Locations</u>	60 to 70	-2.27	-0.07
Centaur Station, 97.8 inches	50 to 60	-1.08	+0.28
Centaur Clock Angle, 177° and 357°	40 to 50	-0.75	0
	30 to 40	-0.06	-0.01
	20 to 30	+0.35	+0.04
	10 to 20	+2.03	+1.69
PLF Station, 2535.4 inches	0 to 10	+2.76	+1.91
PLF Clock Angle, 128° and 308°	-10 to 0	+2.91	+1.81
	-20 to -10	+2.20	+1.02
	-30 to -20	+1.05	-0.36
	-40 to -30	-0.09	-0.75
	-50 to -40	-0.53	-1.33
<b>Vehicle Min. RF Loss</b>			
6.8 dB, with PLF	-60 to -50	-1.35	-1.33
2.3 dB, no PLF	-70 to -60	-2.48	-1.98
	-80 to -70	-2.77	-2.84
	-90 to -80	-3.16	-4.13

Table 3.1.2.1-5: Atlas V 500 Series S-Band Transmitter and RF Characteristics

<b>TRANSMITTER</b>				
p/n 55-03053-3				
Frequency	2211	MHz		
Frequency Stability	4.4	kHz		
Bandwidth	±4	MHz		
Modulation	BPSK/QPSK			
Telemetry Rate (NRZ-M)	1024 or 256	kbps I - Channel		
Forward Error Correction	Convolutional	Rate 1/2, k=7		
	3200 or 200	kbps Q - Channel		
Output Power:				
Single Port	26.0	watt minimum		
	45.0	watt maximum		
Dual Port	11.6	watt minimum		
	25.4	watt maximum		
<b>ANTENNA SYSTEM</b>				
p/n 58-03220-3				
<u>Type</u>				
Clock Angle Pattern Cut (0 to 360°) in 10° (theta) bands.				
		(includes 3 dB power split)		(no 3 dB power split)
<u>Slot</u>	Theta (deg)	Omni, with PLF <sup>(1)</sup> Gain dBi Max.	Omni, no PLF Gain dBi Max.	Single Antenna, no PLF Gain dBi Max.
RHC Polarized	80 to 90	-0.99	-6.03	-3.31
	70 to 80	+0.01	-2.93	-0.57
<u>Locations</u>	60 to 70	+1.65	-0.20	+1.82
Centaur Station, 97.8 inches	50 to 60	+1.65	+1.87	+3.87
Centaur Clock Angle, 177° and 357°	40 to 50	+1.44	+2.50	+4.99
	30 to 40	+2.40	+2.50	+5.21
	20 to 30	+3.54	+2.26	+5.17
	10 to 20	+3.54	+1.86	+4.87
Booster Station, 2041.6 inches	0 to 10	+3.86	+1.65	+4.66
Booster Clock Angle, 180° and 357.6°	-10 to 0	+3.86	+1.44	+4.40
	-20 to -10	+3.60	+1.25	+4.16
	-30 to -20	+2.92	+0.75	+3.63
	-40 to -30	+2.01	+0.17	+2.69
	-50 to -40	+0.89	-0.57	+1.86
<b>Vehicle Min. RF Loss</b>	-60 to -50	-0.04	-1.68	+0.80
8.7 dB, with PLF	-70 to -60	-0.54	-1.97	+0.30
1.1 dB, no PLF	-80 to -70	-0.87	-2.30	-0.28
	-90 to -80	-2.53	-2.30	-0.84

**Note:**

<sup>(1)</sup> This antenna pattern is from the telemetry antennas located on the Booster Interstage Adapter (BISA) and used prior to payload fairing jettison.



Table 3.1.2.1-6: Atlas V 500 Series Flight Termination System (FTS) Receiver and RF Characteristics

<b>RECEIVER</b>			
p/n 58-03230-1			
Frequency		421.0	MHz
Stability		±0.0005	% of 410.3 MHz
Bandwidth		0.180	MHz
Sensitivity		-107.0	dBm minimum
<b>ANTENNA SYSTEM</b>		Clock Angle Pattern Cut (0 to 360°) in 10° (theta) bands.	
p/n 58-03220-3		(includes 3 dB power split)	
<u>Type</u>	Theta (deg)	Omni, with PLF Gain dBi Max.	Omni, no PLF Gain dBi Max.
Slot			
Linear Vertical Polarized	80 to 90	-5.62	-2.34
	70 to 80	-4.67	-2.62
<u>Locations</u>	60 to 70	-2.20	-2.78
Centaur Station, 106.9 inches	50 to 60	-3.04	-1.32
Centaur Clock Angle, 177° and 357°	40 to 50	-3.25	-2.50
	30 to 40	-3.90	-2.57
	20 to 30	-4.85	-2.54
	10 to 20	-4.31	-2.20
PLF Station, 2526.4 inches	0 to 10	-4.53	-2.20
PLF Clock Angle, 128° and 308°	-10 to 0	-4.02	-2.10
	-20 to -10	-4.98	-2.23
	-30 to -20	-3.71	-2.27
	-40 to -30	-2.75	-2.33
<b>Vehicle Min. RF Loss</b>	-50 to -40	-3.26	-2.75
2.2 dB, with PLF	-60 to -50	-2.92	-1.96
3.0 dB, no PLF	-70 to -60	-3.16	-1.37
	-80 to -70	-3.75	-1.39
	-90 to -80	-3.90	-2.52

Figure 3.1.2.1-1 shows the theoretical worst-case intentional radiated Electric (E)-field emissions generated by a 400 series LV as observed at the top of the Centaur Forward Adapter (CFA). The curve is based on transmitter carrier frequency and assumes (1) maximum transmit output power, (2) maximum antenna gain (measured 76 degrees from bore-sight), and minimum passive line loss (i.e., measured values at transmit frequency applied across the entire frequency spectrum), (3) no shielding from the PLF or other structures, and (4) an equipotential plane field level as observed at the top of the CFA.

Figure 3.1.2.1-2 shows the theoretical worst-case intentional radiated E-field emissions generated by a 500 series LV as observed at the top of a C22 payload adapter. The curve is based on transmitter carrier frequency and assumes (1) maximum transmit output power, (2) maximum antenna gain (measured 70 degrees from bore-sight), and minimum passive line loss (i.e., measured values at transmit frequency applied across the entire frequency spectrum), (3) no shielding from the PLF or other structures, and (4) an equipotential plane field level as observed at the top of the C22 adapter.

Actual levels encountered by the SC (influenced by many factors) can only be less than the levels depicted in the figures. Initial reductions are provided to the user on determination of which LV and payload adapter(s) will be used. ULA addresses intentional E-field levels at mission-unique Standard Interface Plane (SIP) locations on an individual basis.

**3.1.2.2 Launch Vehicle Unintentional RF Emissions**

Figures 3.1.2.1-1 and 3.1.2.1-2 depict the unintentional Radio Frequency (RF) emissions generated by the LV. LV unintentional emissions shall not exceed an E-field level of 114 dBµV/m in the frequency range from 14 kHz to 18 GHz.

Figure 3.1.2.1-1: Atlas V 400 Series Launch Vehicle Electric Field Radiation Observed at Top of CFA

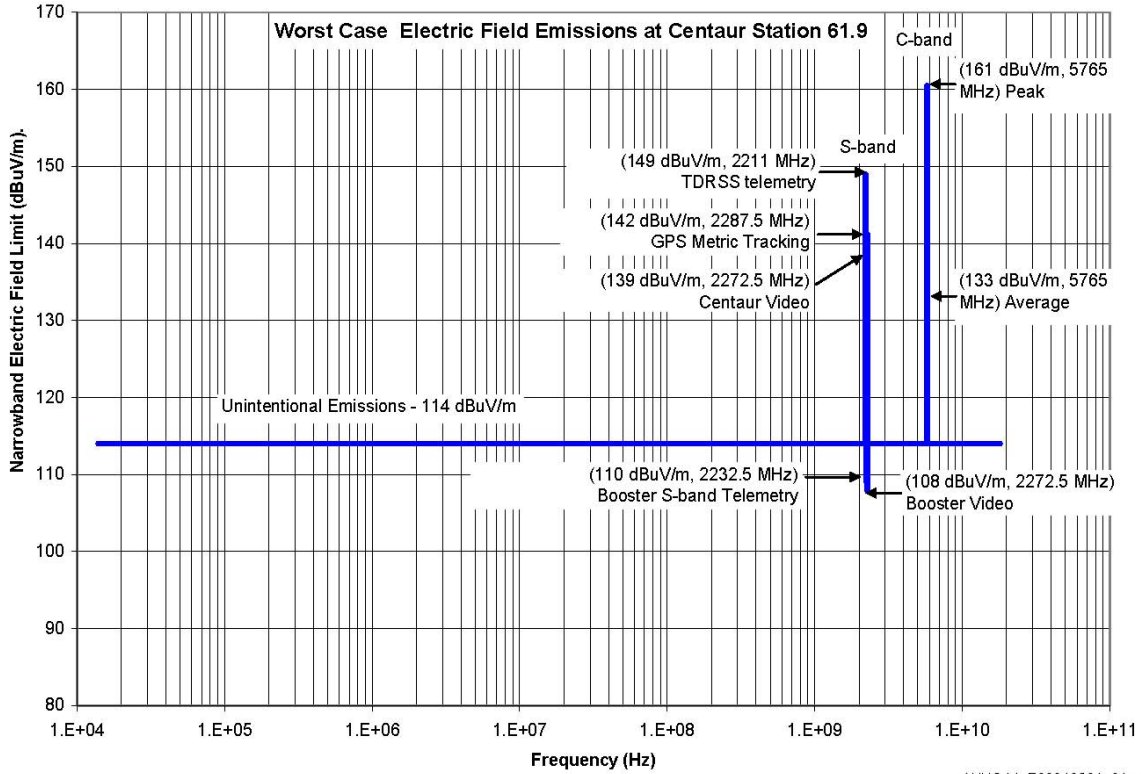
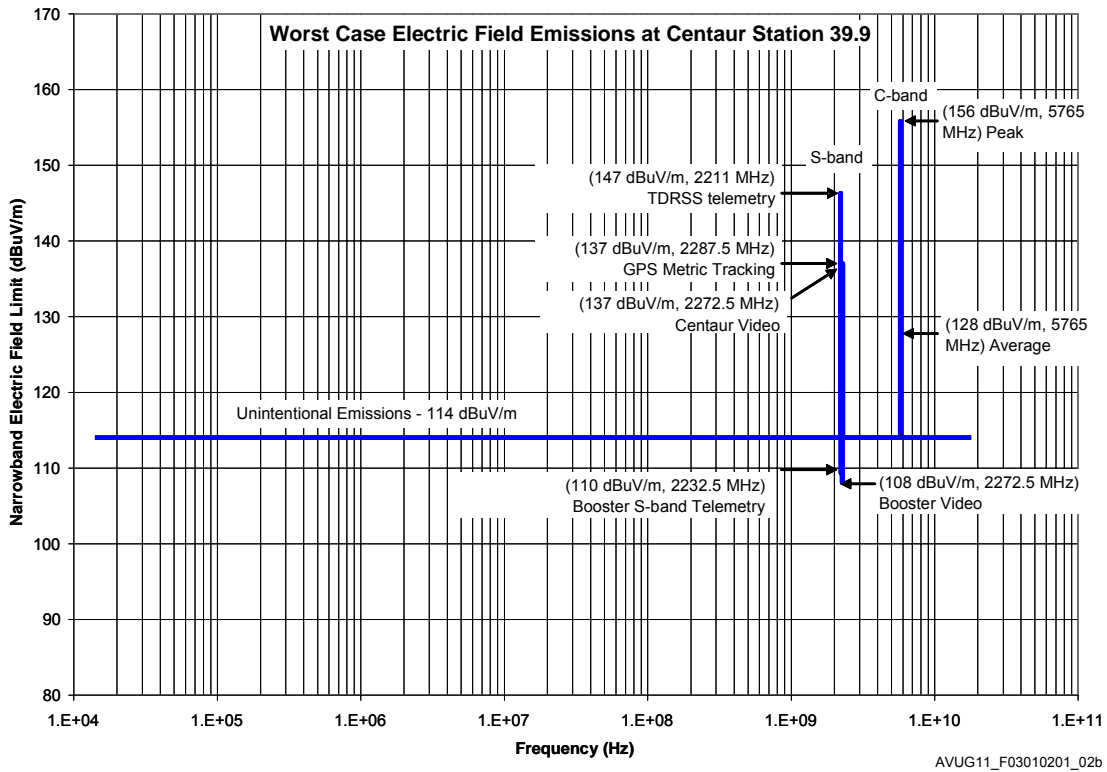


Figure 3.1.2.1-2: Atlas V 500 Series Launch Vehicle Field Radiation Observed at Top of C22



### 3.1.2.3 Launch Range Electromagnetic Environment

An EMC analysis will be performed to ensure EMC of the SC/LV with the Eastern and Western Range environments, including updates as available. On customer request, the LV will coordinate with the Range to address SC issues with Range-controlled EM emitters during transport from the payload processing facility to the launch site and at the launch complex itself.

Tables 3.1.2.3-1 and 3.1.2.3-2 depict the EM emitters in the vicinity of CCAFS. The launch range EM environment is primarily based on information in TOR-2005 (1663)-3790 "Cape Canaveral Spaceport Radio Frequency Environment," November 2005; Rev G (UFOUO) E-field intensities during transport from Astrotech and at SLC-41 are also shown. Data can be provided for other locations upon request. The launch site RF environment is dynamic and subject to change. These data represent the known (peak\*) RF environment as of the date of this publication. The launch site and transport RF environment data will be updated in the mission Interface Control Documents (ICDs) on an as-needed basis.

\*Peak levels are defined in the TOR as the root-mean-square value of the continuous-wave sinusoid for that portion of the duty cycle when the emitter is active

Tables 3.1.2.3-3 and 3.1.2.3-4 list EM emitters in the vicinity of VAFB. These data are based on EM site survey, "Field Strength Measurement Data Summary at the Western Range;" CDRL B534 dated 30 June 2004, provided by Western Range (WR).

Launch trajectory and uncontrolled emitters in the area, such as nearby cruise ships or Navy vessels, may cause RF environments to exceed the levels shown in these tables. Emitters less than 1 V/m are not recorded. On customer request, the LV will coordinate with the WR to address SC issues with range controlled EM emitters during transport from the Integrated Processing Facility (IPF) and at the SLC-3E launch complex.

Table 3.1.2.3-1: Worst-Case (Peak) RF Environment during Transport from Astrotech Spaceflight Operations to SLC-41

Emitter Name	Frequency (MHz) <sup>(1)</sup>	Theoretical Intensity (Peak) <sup>(1)(3)</sup> (V/m)	Duty Cycle <sup>(1)(2)</sup>	Typical Mitigation <sup>(1)</sup>
CSAS Orbit	406.5/416.5/421.0	0.33	1.0	None
Radar ARSR-4	1244.06, 1326.92	<b>1.54</b>	<b>0.0432</b>	[Topography]
GPS Grnd Antenna	1784.74	2.47	1.0	None
NASA STDN	2025 to 2110	6.39	1.0	None
Miscellaneous #1	2710	6.58	0.0012	None
Miscellaneous #2	2702.6-2897.5	1.19	0.0008	None
Miscellaneous #3	2750 & 2840	6.13	0.0008	None
WSR-88D (NEXRAD)	2865	14.57	0.006	None
SRB Retrieval Ship (S-Band)	3049.4	4.49	0.00072	None
SRB Retrieval Ship (S-Band) <sup>(6)</sup>	3049.4	276.12	0.00072	None
Miscellaneous #4	3050	2.20	0.00072	None
Channel 9 Weather	5550	17.38	0.010	None
Channel 2 Weather	5570	<b>6.47</b>	<b>0.0032</b>	[Topography]
WSR-74C	5625	12.62	0.0064	None
TDR 43-250 (Dec. 08)	5625	22.19	0.0030	None
TDWR	5640	<b>14.36</b>	<b>0.010</b>	[Topography]
Radar 0.14 (0.134)	5690	<b>83.97</b>	<b>0.0016</b>	Procedure Mask
Radar 1.16	5690	60.31	0.00064	PRD Action Required
Radar 19.39	5710	83.09	0.005	PRD Action Required
Radar 19.14	5690	182.78	0.0016	PRD Action Required
Radar 19.17	5690	104.53	0.0008	PRD Action Required
Radar 28.14	5690	<b>15.82</b>	<b>0.0016</b>	[Topography]
NDR (MCR) C-Band Pulse Doppler	5525	<b>204.31</b>	<b>0.004</b>	PRD Action Required 5 Degree elevation
SRB Retrieval Ship (X-Band)	9413.6	1.08	0.00072	None
SRB Retrieval Ship (X-Band) <sup>(6)</sup>	9413.6	66.64	0.00072	None
Miscellaneous #5	9410	3.37	0.00072	None
ET Barge Tug	9410	69.57	0.00072	None
Miscellaneous #6	9410	645.22	0.00072	Masking   Measured
Miscellaneous #7	9410	2.40	0.00072	None
Miscellaneous #8 <sup>(7)</sup>	9455	5.78	0.0024	None
Cruise Ships	9410	2.84	<b>0.0012</b>	None
NASA X-Band CW Hangar (Liberty)	10490, 10499	5.19	1.0	None
NASA X-Band CW (LCU)	10490, 10499	1.73	1.0	None
NASA Avian Detector	9410	6.46	0.0005	None
Radar Test Bed	5690	30.03	0.0016	None <sup>(5)</sup>

Note:

- (1) Majority data taken from Aerospace TOR-2005(1663)-3790, "Cape Canaveral Spaceport Radio Frequency Environment," November 2005, Rev. G (UFOUO)
- (2) Avg. V/m = PkV/m\*sqrt (Duty Cycle).
- (3) Non-shaded sources are without specific mechanical or software mitigation measures; bold sources have masking/mechanical or topography and italicized sources indicate no masking or topography controls.
- (4) Measured E-fields indicated by ( ) – measurements performed during the WGS SC-1 transport.
- (5) Radar Test Bed is pointing up when not in use.
- (6) Results based on SRB Retrieval Ship being used as ET Barge tug vessel.
- (7) Radar is not yet installed.

Table 3.1.2.3-2: Worst-Case (Peak) RF Environment at SLC-41

Emitter Name	Frequency (MHz) <sup>(1)</sup>	Theoretical Intensity (Peak) <sup>(1) (3)</sup> (V/m)		Duty Cycle <sup>(1) (2)</sup>	Typical Mitigation <sup>(1)</sup>	
CSAS Orbit	406.5/416.5/421.0	0.23		1.0	None	
Radar ARSR-4	1244.06, 1326.92	<b>1.26</b>		<b>0.0432</b>	[Topography] <sup>(5)</sup>	
GPS Grnd Antenna	1784.74	2.25		1.0	None	
NASA STDN	2025 to 2110	0.93		1.0	None	
Miscellaneous #1	2710	4.46		.0012	None	
Miscellaneous #2	2702.6-2897.5	1.06		0.0008	None	
Miscellaneous #3	2750 & 2840	5.19	(2.18)	0.0008	None	Measured
WSR-88D (NEXRAD)	2865	<b>12.69</b>	<b>(0.10)</b>	<b>0.006</b>	[Topography] <sup>(5)</sup>	Measured
SRB Retrieval Ship (S-Band)	3049.4	3.58		0.00072	None	
SRB Retrieval Ship (S-Band) <sup>(8)</sup>	3049.4	16.91		0.00072	None	
Miscellaneous #4	3050	1.59		0.00072	None	
Channel 9 Weather	5550	9.930		0.010	None	
Channel 2 Weather	5570	<b>4.66</b>		<b>0.0032</b>	[Topography] <sup>(5)</sup>	
WSR-74C	5625	10.58	(0.07)	0.0064	None	Measured
TDR 43-250 (Dec. 08)	5625	10.39		0.0030	None	
TDWR	5640	<b>9.97</b>		<b>0.010</b>	[Topography] <sup>(5)</sup>	
Radar 0.14 (0.134)	5690	<b>71.7<sup>(4)</sup></b>		<b>0.0016</b>	Procedure Mask	
Radar 1.16	5690	<b>52.6<sup>(4)</sup></b>		<b>0.00064</b>	Procedure Mask	
Radar 19.39	5710	<b>29.8<sup>(4)</sup></b>		<b>0.005</b>	Procedure Mask	
Radar 19.14	5690	<b>106.4<sup>(4)</sup></b>		<b>0.0016</b>	Procedure Mask	
Radar 19.17	5690	<b>55.1<sup>(4)</sup></b>		<b>0.0008</b>	Procedure Mask	
Radar 28.14	5690	<b>15.5</b>		<b>0.0016</b>	Topography <sup>(5)</sup>	
NDR (MCR) C-Band Pulse Doppler	5525	<b>173.0<sup>(4)</sup></b>		<b>0.004</b>	5 Degree Elevation	
SRB Retrieval Ship (X-Band)	9413.6	0.86		0.00072	None	
SRB Retrieval Ship (X-Band) <sup>(8)</sup>	9413.6	4.08		0.00072	None	
Miscellaneous #5 (X-Band)	9410	2.43		0.00072	None	
Miscellaneous #6	9410	41.93	(0.13)	0.00072	Masking	Measured
Miscellaneous #7	9410	1.94		0.00072	None	
ET Barge Tug	9410	4.17		0.0012	None	
Miscellaneous #8 <sup>(9)</sup>	9455	3.52		0.0024	None	
Cruise Ships	9410	2.19		0.0012	None	
NASA X-Band CW Hanger (Liberty)	10490, 10499	4.15		1.0	None	
NASA X-Band CW (LCU)	10490, 10499	1.73		1.0	None	
NASA Avian Detector	9410	2.41		0.0005	None	
Radar Test Bed	5690	25.52		0.0016	None <sup>(7)</sup>	

- (1) Majority data taken from Aerospace TOR-2005(1663)-3790, "Cape Canaveral Spaceport Radio Frequency Environment," November 2005, Rev. G (UFOUO)
- (2) Avg. V/m = PkV/m\*sqrt (Duty Cycle).
- (3) Non-shaded sources are without specific mechanical or software mitigation measures; bold sources have masking/mechanical or topography and italicized sources indicate no masking or topography controls.
- (4) In-flight tracking levels for Tracking Radars (0.14, 1.16, 19.39, 19.14, 19.17 and NASA C-Band) are typically 20 V/m.
- (5) E-field levels are above the VIF/MLP – E-fields will be seen after launch.
- (6) Measured E-fields indicated by ( ) – in VIF at Level 6 – Test Report, BOEING-KSC-N120-53434-05 dated 9 February 2005.
- (7) Radar Test Bed is pointing up when not in use.
- (8) Results based on closest approach during ET Barge transit.

(9) Radar is not yet installed.

**Table 3.1.2.3-3: Worst-Case (Peak) RF Environment during Transport from IPF to SLC-3E**

Emitter Name	Frequency (MHz) <sup>(1)</sup>	Theoretical Intensity (Peak) (V/m) <sup>(1)</sup>	Duty Cycle <sup>(1)(2)</sup>	Typical Mitigation <sup>(1)</sup>
CT-1	416.5/421.0	0.53	1.0	NC
CT-5	416.5/421.0	11.95	1.0	NC
CT-3	416.5/421.0	<b>5.27</b>	<b>1.0</b>	Topography
ATCBI-6	1030	0.07	1.0	NC
AN/FRN-45	1146	0.06	0.0252	NC
ARSR-4	1262 & 1345	<b>33.4</b>   <b>(7.00)<sup>(6)</sup></b>	<b>0.02592</b>	Topography   Measured
SGLS-46	1750-1850	2.23	1.0	NC
FPS-16-1	5725	<b>131.2</b>	<b>0.00064</b>	Topography
HAIR	5400-5900	427.5	0.002	TBD
MPS-39/MOTR	5400-5900	<b>173.0</b>	<b>0.0640</b>	Topography
TPQ-18	5840	1981.40	0.000384	TBD
NEXRAD	2890	25.5   (21.2) <sup>(7)</sup>	0.006149	NC
PULSTAR	9245 & 9392	38.9	0.010	TBD
Miscellaneous Radars	9410	<b>22.5</b>	<b>0.00072</b>	Procedure Masked – Sector Controlled

**Notes:**

- (1) Majority data taken from Field Strength Measurement Data Summary at the Western Range, CDRL B534 dated 30 June 2004 and Range provided Updates.
- (2) Avg. V/m = PKV/m\*sqrt (Duty Cycle).
- (3) NC = Not Controlled.
- (4) NSO = No Signal Observed.
- (5) Non-shaded sources are without specific mechanical or software mitigation measures; bold sources have masking/mechanical or topography and italicized sources indicate no masking or topography controls.
- (6) Measured E-fields indicated by ( ) – Observed during EPF Transport Demonstration/LSIC Input.
- (7) Measured E-fields ( ) during hoist at SLC-3E.

**Table 3.1.2.3-4: Worst-Case (Peak) RF Environment for VAFB SLC-3E**

Emitter Name	Frequency (MHz) <sup>(1)</sup>	Theoretical Intensity (Peak) <sup>(1)(3)</sup> (V/m)	Duty Cycle <sup>(1)(2)</sup>	Typical Mitigation <sup>(1)</sup>
CT-1	416.5/421.0	0.50	1.0	NC
CT-5	416.5/421.0	3.08	1.0	NC
CT-3	416.5/421.0	<b>1.71</b>	<b>1.0</b>	Topography <sup>(7)</sup>
ATCBI-6	1030	0.04	1.0	NC
AN/FRN-45	1146	0.05	0.0252	NC
ARSR-4	1262 & 1345	<b>18.1</b>	<b>0.02592</b>	Topography <sup>(7)</sup>
SGLS-46	1750-1850	2.15	1.0	NC
FPS-16-1	5725	<b>119.3</b>	<b>0.00064</b>	Topography <sup>(7)</sup>
HAIR	5400-5900	359.8	0.002	TBD
MPS-39/MOTR	5400-5900	<b>157.3</b>	<b>0.0640</b>	Topography <sup>(7)</sup>
TPQ-18	5840	1431.05	0.000384	TBD
NEXRAD	2890	25.8	0.006149	NC
PULSTAR	9245 & 9392	33.1	0.010	TBD
Miscellaneous Radars	9410	<b>3.73</b>	<b>0.00072</b>	Procedure Masked – Sector Controlled

**Note:**

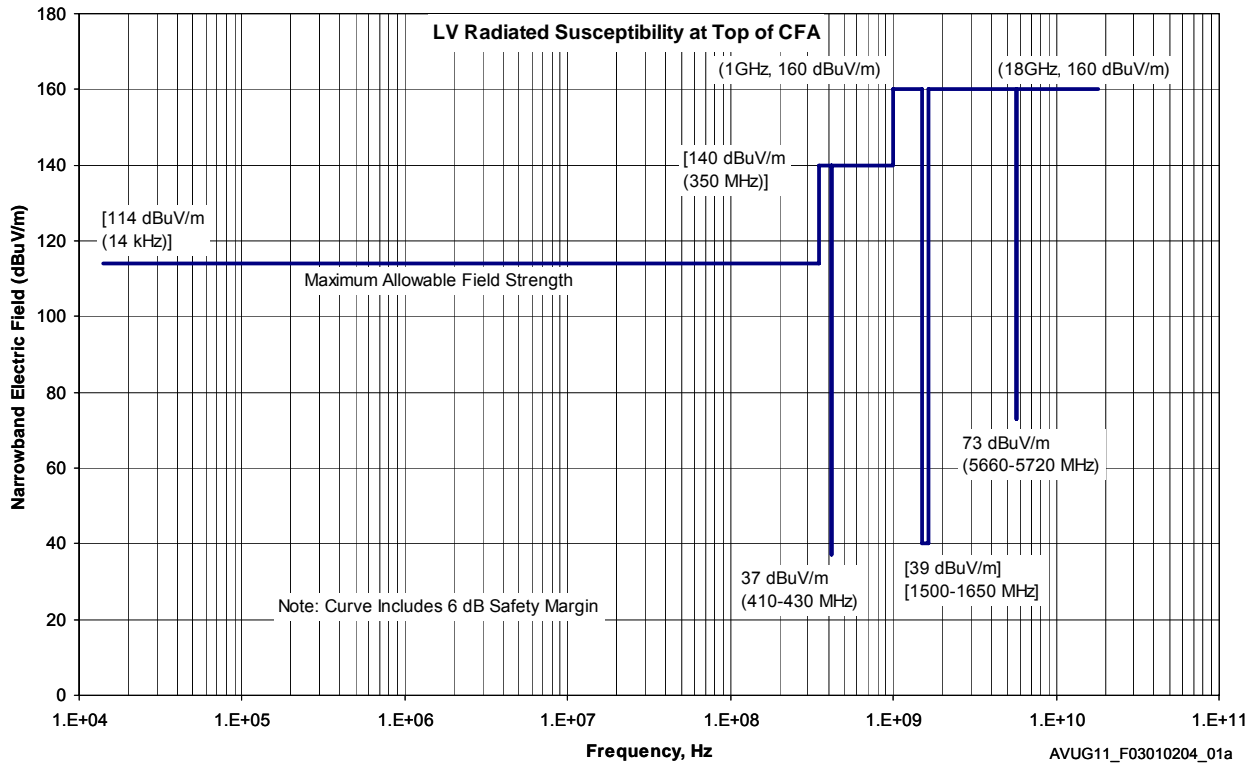
- (1) Majority data taken from Field Strength Measurement Data Summary at the Western Range, CDRL B534 dated 30 June 2004 and Range provided Updates.
- (2) Avg. V/m = PKV/m\*sqrt (Duty Cycle).
- (3) NC = Not Controlled.
- (4) NSO = No Signal Observed.
- (5) Non-shaded sources are without specific mechanical or software mitigation measures; bold sources have masking/mechanical or topography and italicized sources indicate no masking or topography controls.
- (6) In-flight tracking levels for Tracking Radars (FPS-16-1, HAIR, MPS-39/MOTR, TPQ-18 and PULSTAR) are typically 20 V/m.
- (7) E-field levels are above the SLC-3E – E-fields will be seen after launch.

**3.1.2.4 Spacecraft-Generated EMC Environment Limitation**

During ground and launch operation time frames through SC separation, any SC Electromagnetic Interference (EMI) radiated emissions (including antenna radiation) should not exceed values depicted in Figure 3.1.2.4-1. LV/SC external interfaces (EMI-conducted emissions) must be examined individually. SC shall provide available unintentional radiated emissions data to the LV in the frequency ranges from 410 to 430 MHz, 1500 to 1650 MHz, and from 5660 to 5720 MHz.

Each SC will be treated on a mission-unique basis. Assurance of the LV/SC EMC with respect to payload emissions will be a shared responsibility between ULA and the SC contractor.

**Figure 3.1.2.4-1: Spacecraft Electric Field Radiation Impingement on Launch Vehicle**

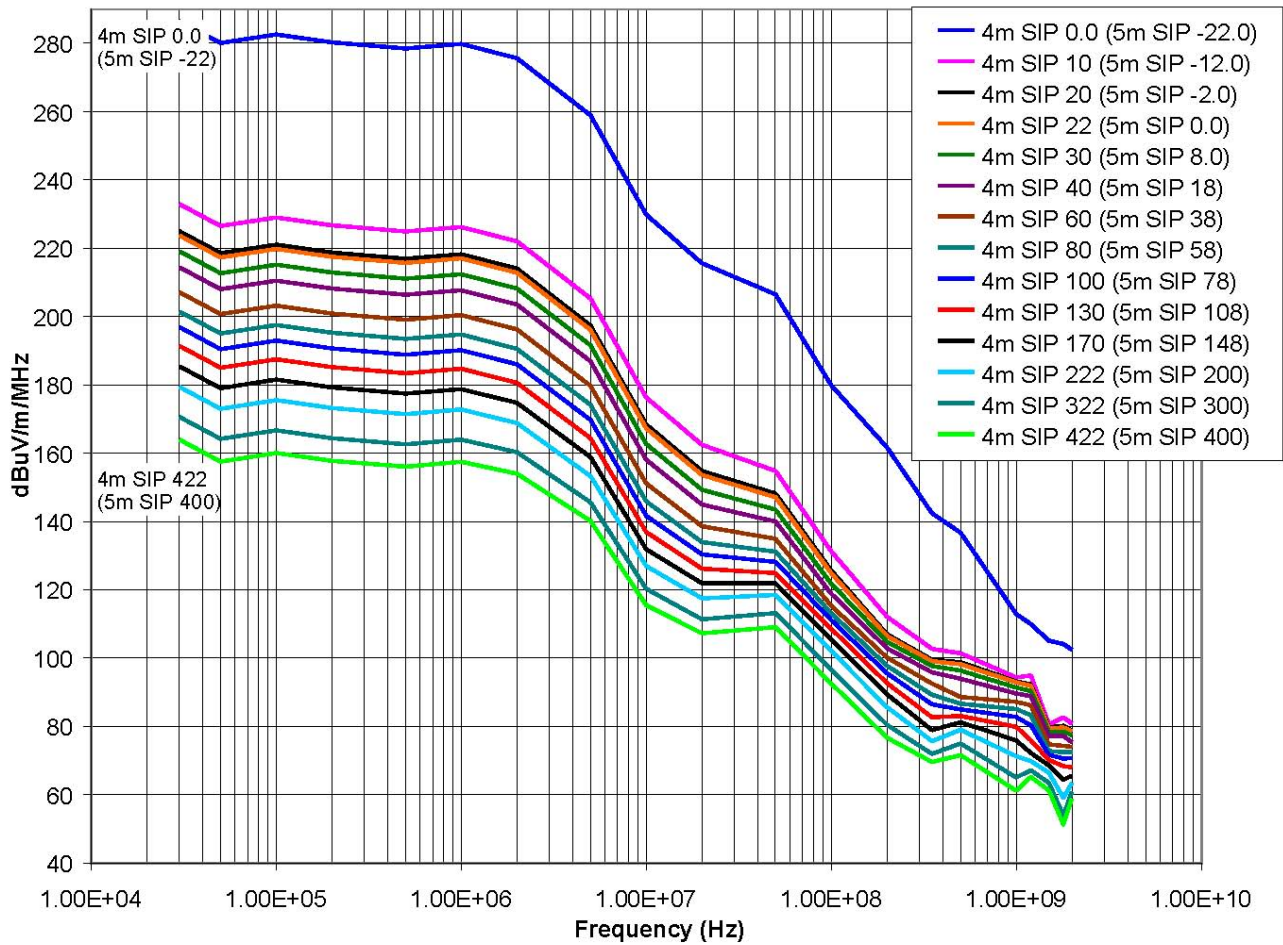


**3.1.2.5 Electrostatic Discharge Events**

**3.1.2.5.1 Centaur Non-Conductive Materials**

The Centaur vehicle, depending on the trajectory employed to deliver the SC to orbit, can fly through parts of the Earth's Magnetic L-shells. If the trajectory up through SC separation altitude and location (as determined by ULA) indicates no passage beyond an L-shell value of 5.5, charging of the Centaur non-conductive materials will not occur. However, if the trajectory indicates passage beyond an L-shell of 5.5, charging of the Centaur non-conductive materials can occur resulting in an Electrostatic Discharge (ESD) event. Figure 3.1.2.5.1-1 displays the expected peak ESD broadband E-field emissions that would be present at various SIP stations, starting at the top of the CFA (4m SIP station 0.0, 5m SIP station -22.0) and going forward. Note that SIP stations are given for both Atlas V 400 and 500 series vehicles.

Figure 3.1.2.5.1-1: Peak Broadband E-field Emissions due to ESD on Centaur



AVUG11\_F0301020501\_01a

### 3.1.2.6 Lightning Mitigation Features

At CCAFS, a catenary system at the SLC-41 pad and a down conduct system at the VIF mitigate against direct lightning attachment to the LV. Lightning mitigation at VAFB is achieved via the Mobile Service Tower (MST) when in the service position and by an air terminal located on the Umbilical Tower (UT) when the MST is in the park position. In addition, shielded payload umbilical cabling is provided between the LV and the ground support equipment at each site. Additional measures beyond these standard capabilities are the responsibility of the SC contractor.

### 3.1.3 Prelaunch Contamination Control and Cleanliness

The Atlas V launch system design limits contamination depositions from all launch system sources onto SC surfaces to a molecular thickness of 150 Angstroms and a particle obscuration of 1.0% for most missions. These deposition limitations include all launch system sources from the start of SC encapsulation operations through the end of the Collision and Contamination Avoidance Maneuver (CCAM), which follows SC separation. This section addresses Atlas contamination control during prelaunch operations. Section 3.2.7 addresses in-flight LV contamination sources.

Launch vehicle hardware that comes into contact with the SC environment has been designed and manufactured according to strict contamination control guidelines. This hardware is defined as



“contamination critical.” Contamination critical surfaces include the Centaur forward adapter, PLF interior, boattail interior, payload adapter, and for the 5-m PLFs, the top of the Centaur forward load reactor.

In addition, ground operations at the launch site have been designed to ensure a clean environment for the SC. A comprehensive Contamination Control Plan has been written to identify these requirements and procedures. A mission-unique appendix will be written to supplement the contamination control plan if the mission-unique requirements identified in the ICD are more stringent than those baselined in the control plan. Some guidelines and practices used in the plan are found in the following paragraphs. Analysis of LV contamination of the SC is discussed in Section 4.2.11.

### 3.1.3.1 Contamination Control Before Launch Site Delivery

**Design and Assembly** — ULA implements contamination control principles in design and manufacturing processes to limit the amount of contamination from LV components. Interior surfaces include maintainability features to facilitate the removal of manufacturing contaminants. Contamination-critical hardware is entered into a controlled production phase in which the hardware is cleaned and maintained clean to prevent contaminants in difficult-to-clean places at the end of production. To support this effort, final assembly of payload adapters, the PLF, and the Centaur vehicle is performed in a Class 100,000 facility to ensure that hardware surfaces and, in particular, any entrapment areas are maintained at an acceptable level of cleanliness before shipment to the launch site. Inspection points verify cleanliness throughout the assembly process. Approved clean room wrapping protects critical surfaces during contaminant generating activities.

**Materials Selection** — In general, ULA selects materials for contamination-critical hardware inside the PLF that will not become a source of contamination to the SC. Metallic or nonmetallic materials that are known to chip, flake, or peel are prohibited. Materials that are cadmium-plated, zinc-plated, or made of unfused electrodeposited tin are avoided inside the PLF volume. Corrosion-resistant materials are selected wherever possible and dissimilar materials are avoided or protected according to MIL-STD-889B. Because most nonmetallic materials are known to exhibit some out gassing, these materials are evaluated against criteria that were developed using NASA SP-R-0022 as a starting point.

### 3.1.3.2 Contamination Control Before Spacecraft Encapsulation

**Cleanliness Levels** — Contamination-critical hardware surfaces are cleaned and inspected to Visibly Clean Level 2. These checks confirm the absence of all particulate and molecular contaminants visible to the unaided eye at a distance of 15.2-45.7 cm (6-18 in.) with a minimum illumination of 1,076 lumen/m<sup>2</sup> (100 foot-candles [fc]). Hardware cleaned to this criterion at the assembly plant is protected to maintain this level of cleanliness through shipping and encapsulation.

Contingency cleaning may also be required to restore this level of cleanliness if the hardware becomes contaminated. Contingency cleaning procedures outside of the encapsulation facility before encapsulation are subject to Atlas V program engineering approval. The cognizant SC engineer must approve any required cleaning of LV hardware in the vicinity of the SC.

Certain SC may require that contamination critical hardware surfaces be cleaned to a level of cleanliness other than Visibly Clean Level 2. Because additional cleaning and verification may be necessary, these requirements are implemented on a mission-unique basis.

**PLF Cleaning Techniques** — The Atlas V program recognizes that cleaning of large, interior PLF surfaces depends on implementation of well-planned cleaning procedures. To achieve customer requirements, all cleaning procedures are verified by test, reviewed and approved by Material and Processes Engineering. Final PLF cleaning and encapsulation is performed in a Class 100,000 facility.

**Cleanliness Verification** — The Atlas V program visually inspects all contamination-critical hardware surfaces to verify Visibly Clean Level 2 criteria as described above. For Atlas V, contamination critical

surfaces are also verified to have less than 1 mg/ft<sup>2</sup> of Nonvolatile Residue (NVR). The additional verification techniques shown below can be provided on a mission-unique basis:

1. Particulate Obscuration — Tape lift sampling
2. Particulate Obscuration — Ultraviolet light inspection
3. Particulate and Molecular Fallout — Witness plates

### 3.1.3.3 Contamination Control After Encapsulation

**Contamination Diaphragm** — The Atlas V program provides contamination barriers for 4-m and 5-m PLFs to protect the SC from possible contamination during transport and hoist. After the two halves of the PLF are joined, the encapsulation is completed by closing the aft opening with a ground support equipment Kevlar-reinforced, Teflon-coated diaphragm. The toroidal diaphragm stretches from the payload adapter to the aft end of the PLF cylinder and creates a protected environment for the SC from mating to the Centaur through final LV closeouts prior to launch, typically one day before launch.

For the 5-m payload fairings, the entire Centaur is contained within the PLF. In this case, the LV is designed so the direction of the conditioned airflow is toward the aft end of the PLF, through the Centaur Forward Load Reactor (CFLR) deck, to minimize SC exposure from sources aft of the CFLR.

**PLF Purge** — After encapsulation, the PLF environment is continuously purged with filtered nitrogen or High-Efficiency Particulate Air (HEPA) or Ultra Low Penetration Air (ULPA) filtered air to ensure the cleanliness of the environment.

**Personnel Controls** — Personnel controls limit access to the PLF to maintain SC cleanliness. Contamination control training is provided to all LV personnel working in or around the encapsulated PLF. ULA provides similar training to SC personnel working on the SC while at the launch complex to ensure that they are familiar with the procedures.

**SLC-3E Controlled Work Area** — The encapsulated SC is contained within an environmentally controlled area on the Mobile Service Tower. The conditioned air supply to this facility is 90% filtered (removing 90% of particles 0.7 microns and larger).

**The Vertical Integration Facility at SLC-41** — The Atlas V program provides access to the encapsulated SC from work stands situated on Levels 5, 6, and 7. Work procedures and personnel controls are established to maintain the SC environment within the PLF to Class 100,000 standards. Garments are provided to personnel making PLF entry at the Centaur forward adapter station to provide optimum cleanliness control as dictated by SC requirements. A portable clean room tent is available as a mission unique service for entry through mission-unique access doors as required (portable between VIF levels 5, 6, 6.5, and 7).

### 3.1.3.4 Payload Fairing Helium Environment in Prelaunch Operations

The volume between the Centaur Liquid Hydrogen (LH<sub>2</sub>) tank and the Centaur forward adapter is purged with helium while the vehicle is on the pad with the LH<sub>2</sub> tank loaded, to prevent condensation on the hydrogen tank forward bulkhead. Although the Centaur forward adapter is sealed, some helium may leak into the payload compartment. The helium mixes with the GN<sub>2</sub> being provided by the PLF and Centaur forward adapter environmental control systems. At T-8 seconds, a pyro-activated helium vent door opens, venting the Centaur forward adapter helium into the payload compartment. Environmental control and helium purge systems are terminated at T-0 in a normal launch. During ascent, the payload compartment vents to negligible pressure approximately 3 minutes after launch. In case of an aborted launch attempt with the helium vent door open, the helium flow is shut off shortly after abort. The flow is allowed to continue during detanking if the vent door remains closed.

Measured helium concentrations above the Centaur forward adapter are variable; however, the helium exposure will not exceed 750 Torr-hours for SC locations more than 3-feet distant from the Centaur forward adapter. SC locations less than 3 ft. from the CFA structure may be exposed to more than 750 Torr-hr of helium. Some solutions, such as GN<sub>2</sub> purge of sensitive components, are available to helium-sensitive SC on a mission-unique basis.

The Interstage Adapter (ISA) is filled with helium for launch of the Atlas V 500 series and Heavy Lift Vehicle configurations to attenuate the acoustic environment within the ISA. To accomplish this, the ISA is purged with helium for the last 5 minutes before launch. The ISA is vented through the 5-m PLF base module compartment to the PLF vents just below the CFLR deck. Flow of this helium through the CFLR into the payload compartment is minimized by the flow of GN<sub>2</sub> from the payload module ECS, which enters into the payload compartment at a high flow rate and is vented down through the CFLR and out the vents in the PLF base module compartment.

## 3.2 LAUNCH AND FLIGHT ENVIRONMENTS

This section describes general environmental conditions that may be encountered by a SC during launch and flight of the Atlas V LV. A thorough description of each environment is presented in Section 3.2, as well as an outline of necessary SC compatibility testing in Section 3.3. All flight environments defined in this section are maximum expected levels and do not include margins typically associated with qualification tests. Verification analysis necessary to assure SC compatibility with Atlas V environments is performed during the Mission Integration process as described in Section 4.2.

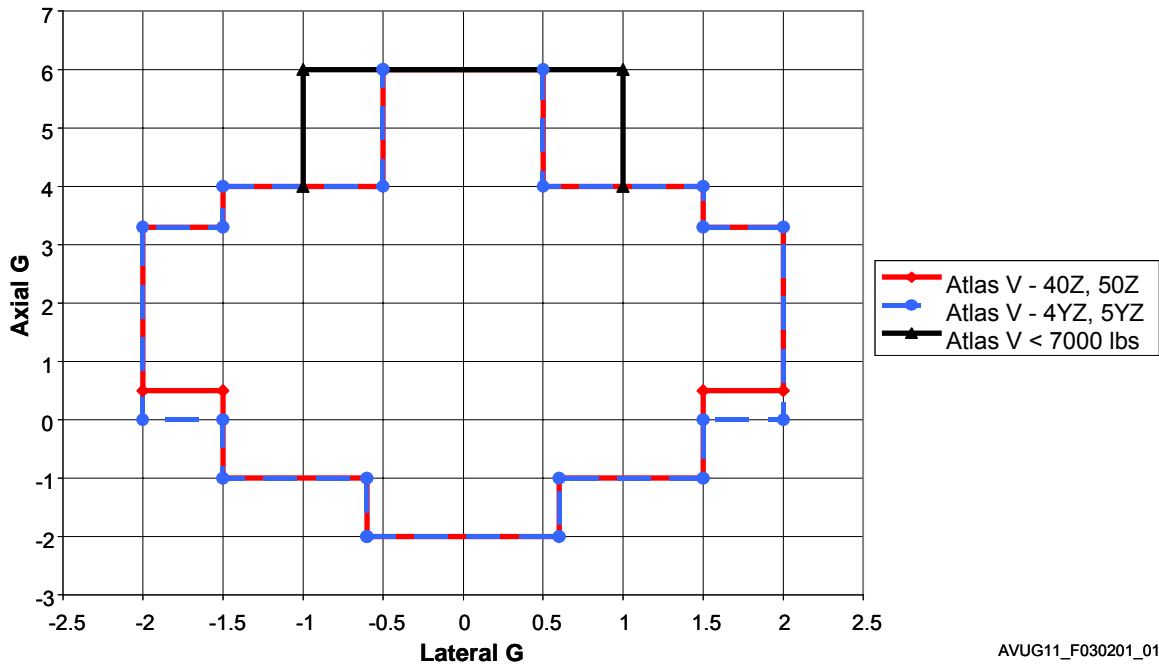
### 3.2.1 Spacecraft Design Load Factors

Design Load Factors (DLF) in Figure 3.2.1-1 and Table 3.2.1-1 are for use in preliminary design of primary structure and/or evaluation of compatibility of existing SC with Atlas V LVs. Factors are provided for each transient event that produces significant SC loading. The total DLF for any direction can be determined by addition of the quasi-steady state and oscillatory dynamic components provided. Uncertainty factors related to SC design maturity are not included in the DLF definitions.

The load factors were derived for application to the Center of Gravity (cg) of a rigid SC to generate a conservative estimate of interface loading. The load factors are applicable only to standard payload adapters as defined in Section 5. The actual responses of a SC due to LV transients will depend on its specific static and structural dynamic characteristics; however, the values provided have generally proven conservative for SC in the weight range of 1,230 to 9,100 kg (2,720 to 20,062 lb). The SC cantilevered fundamental mode frequencies are assumed to be a minimum of 8 Hz lateral and 15 Hz axial to ensure applicability of the design load factors. SC that do not meet these criteria or those with non-standard payload adapters will require configuration specific analyses for assessing compatibility with Atlas V LVs.

Coupled Loads Analyses (CLA) are dynamic analyses conducted as part of the mission integration activity to provide SC primary and secondary structure loads, accelerations, and deflections for use in design, test planning, and verification of minimum margins of safety. CLA results supersede loads derived from the Table 3.2.1-1 load factors.

Figure 3.2.1-1: Spacecraft Design Limit Load Factors



AVUG11\_F030201\_01

Table 3.2.1-1: Spacecraft Design Limit Load Factors

Load Condition	Direction	Atlas V 40Z, 50Z		Atlas v 4YZ, 5YZ	
		Steady State (g)	Dynamic (g)	Steady State (g)	Dynamic (g)
Launch	Axial	1.2	± 0.5	1.5	± 1.5
	Lateral	0.0	± 1.0	0.0	± 2.0
Flight Winds	Axial	1.0 - 2.8	± 0.5	1.0 - 2.8	± 0.5
	Lateral	± 0.4	± 1.6	± 0.4	± 1.6
SRB Jettison	Axial	-	-	3.3	± 0.5
	Lateral	-	-	0.0	± 0.5
BECO/MAX-G >7000 lbs (Max Axial) (Max Lateral)	Axial	5	± 1.0	5	± 1.0
	Lateral	0.0	± 0.5	0.0	± 0.5
	Axial	3.0 - 0.0	± 1.0	3.0 - 0.0	± 1.0
	Lateral	0.0*	± 1.5	0.0*	± 1.5
BECO/MAX-G <7000 lbs (Max Axial) (Max Lateral)	Axial	5	± 1.0	5	± 1.0
	Lateral	0.0	± 1.0	0.0	± 1.0
	Axial	3.0 - 0.0	± 1.0	3.0 - 0.0	± 1.0
	Lateral	0.0*	± 1.5	0.0*	± 1.5
MECO/CLE (Max Axial) (Max Lateral)	Axial	4.5 - 0.0*	± 1.0	4.5 - 0.0*	± 1.0
	Lateral	0.0	± 0.3	0.0	± 0.3
	Axial	0.0	± 2.0	0.0	± 2.0
	Lateral	0.0	± 0.6	0.0	± 0.6
Sign Convention Longitudinal Axis: + (Positive) = Compression - (Negative) = Tension ± May act in either direction					
Lateral and longitudinal loading may act simultaneously during any flight event Loading is applied to the SC cg					
"Y" in vehicle designator is number of SRBs and ranges from 1 to 3 (400 series) 1 to 5 (500 series) "Z" in vehicle designator is number of Centaur engines and is 1 or 2					
* Decaying to zero					

**3.2.2 Acoustics**

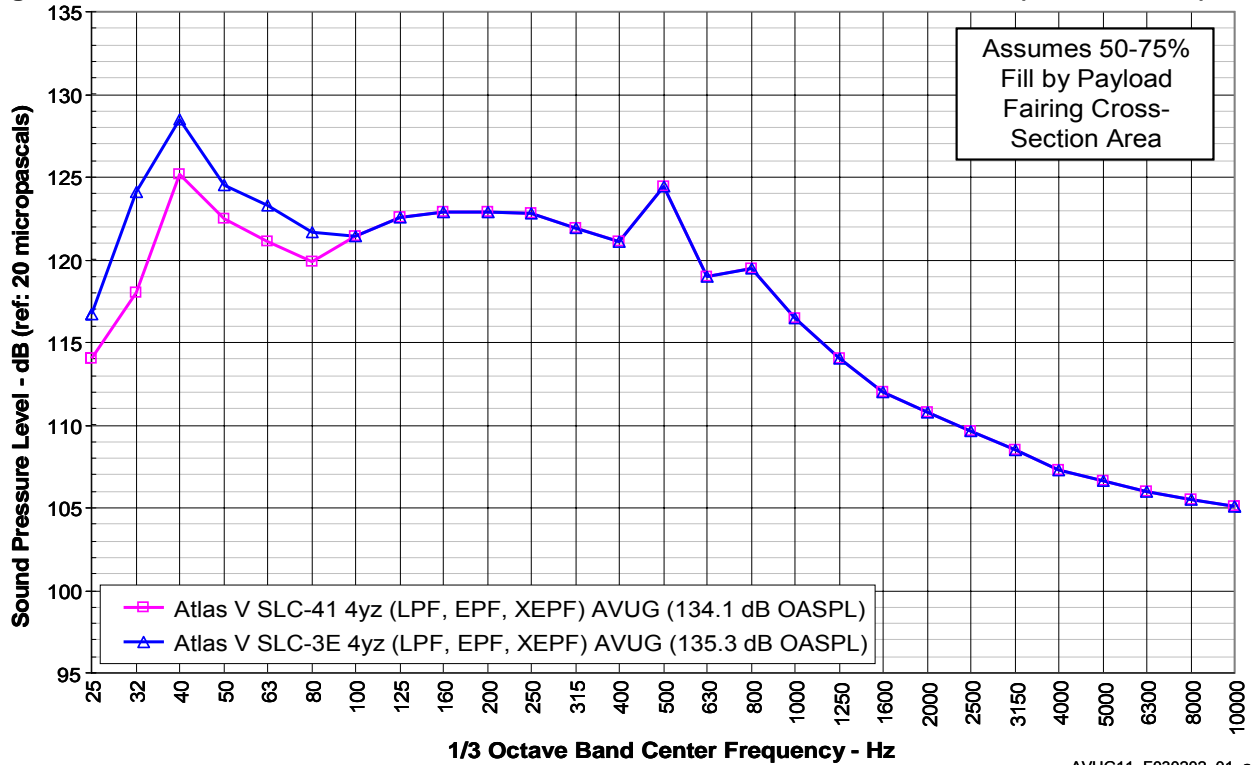
The SC is exposed to an acoustic environment throughout the boost phase of flight until the vehicle is out of the sensible atmosphere. Two portions of flight have significantly higher acoustic levels than any other. The highest acoustic level occurs for approximately 10 seconds during liftoff, when the acoustic energy of the engine exhaust is being reflected by the launch pad. Liftoff acoustic levels differ for SLC-41 and SLC-3E launch sites. The other significant level occurs for approximately 20 seconds during the transonic portion of flight and is due to aerodynamic shock waves and a highly turbulent boundary layer. Acoustic levels inside the PLF are spatially averaged and will vary with different SC due to acoustic absorption that varies with SC size, shape, and surface material properties. Acoustic sound pressure levels for an Atlas V 4-m from SLC-41 or SLC-3E appear in Table 3.2.2-1 and corresponding Figure 3.2.2-1. Acoustic sound pressure levels for an Atlas V 5-m PLF appear in Figure 3.2.2-2 and corresponding Table 3.2.2-2. These figures represent the maximum expected environment based on a 95% probability and 50% confidence (limit level). The levels presented are for SC of square cross sectional shape with typical cross sectional fill ratios of 50-75% for the 4-m PLF and 40-50% for the 5-m PLF. A mission-unique acoustic analysis is required for SC with other fill factors or 5-m PLF configuration vehicles launched from SLC-3E. SC should be capable of functioning properly after 1-minute exposure to these levels.

For 4-m payload fairings, special consideration should be given to components within 76 cm (30 in.) of PLF vents. Sound pressure levels for components near the PLF vents are provided in Figure 3.2.2-3.

**Table 3.2.2-1: Max Acoustic Levels for SLC-41 and SLC-3E Atlas V with 4-m PLF (with Blankets)**

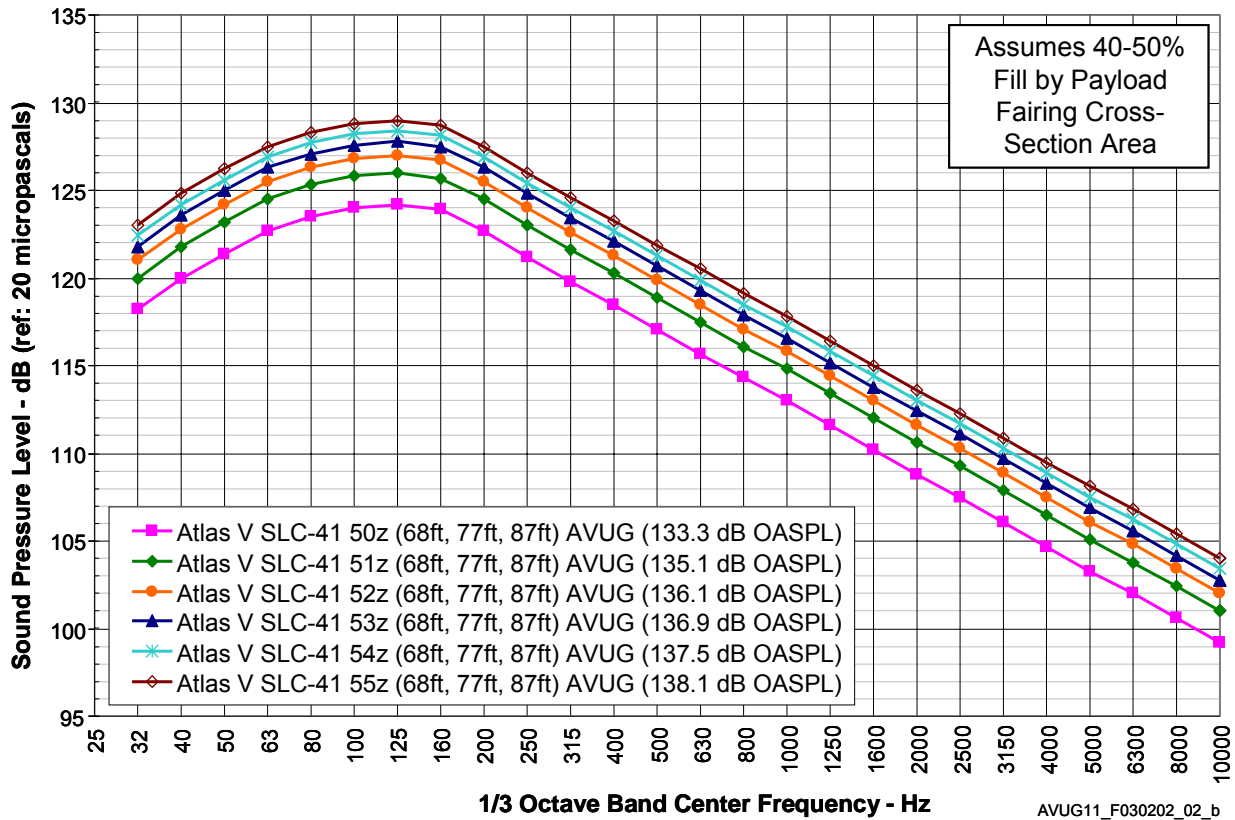
Frequency (Hz)	SLC-41	SLC-3E
25	114.0	116.7
32	118.0	124.1
40	125.2	128.5
50	122.5	124.5
63	121.1	123.3
80	119.9	121.7
100	121.4	121.4
125	122.6	122.6
160	122.9	122.9
200	122.9	122.9
250	122.8	122.8
315	121.9	121.9
400	121.1	121.1
500	124.4	124.4
630	119.0	119.0
800	119.5	119.5
1000	116.5	116.5
1250	114.0	114.0
1600	112.0	112.0
2000	110.8	110.8
2500	109.6	109.6
3150	108.5	108.5
4000	107.3	107.3
5000	106.6	106.6
6300	106.0	106.0
8000	105.5	105.5
10000	105.1	105.1
OASPL (dB)	134.1	135.3
Baseline: 95% probability and 50% confidence assumes 50 to 75% fill by PLF cross-sectional area. dB ref: 20 Micropascals, applies to all 4-m PLF Configurations (LPF, XPF, XEPF) and all 400 series vehicle configurations (0-3 SRBs)		

Figure 3.2.2-1: Max Acoustic Levels for SLC-41 and SLC-3E Atlas V with 4-m PLF (with Blankets)



AVUG11\_F030202\_01\_a

Figure 3.2.2-2: Max Acoustic Levels for SLC-41 Atlas V with 5-m PLF

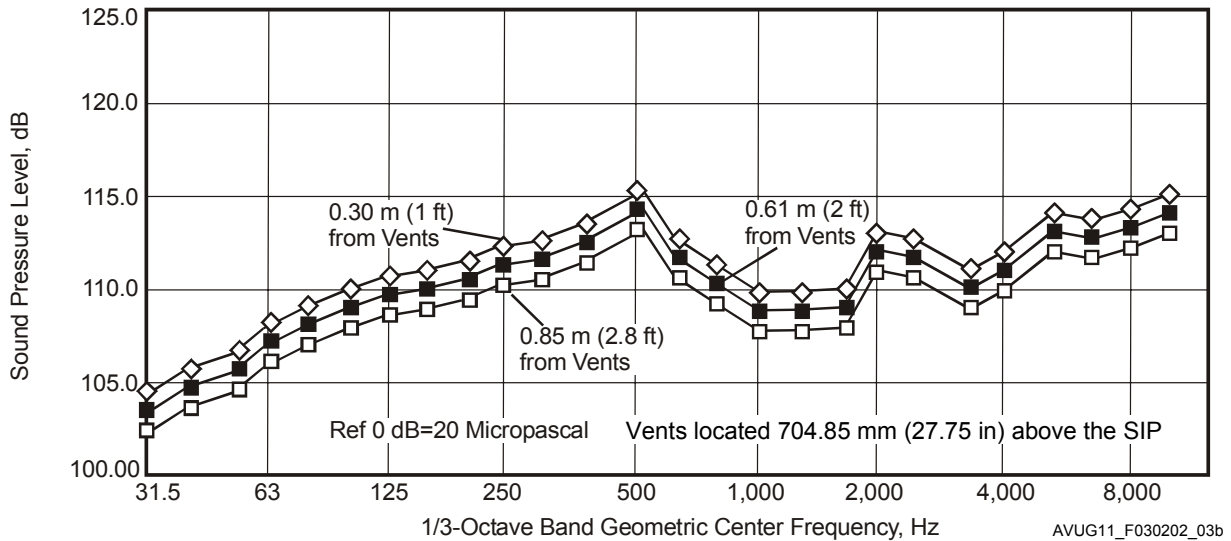


AVUG11\_F030202\_02\_b

Table 3.2.2-2: Max Acoustic Levels for SLC-41 Atlas V with 5-m PLF

Frequency (Hz)	55z (68ft, 77ft, 87ft)	54z (68ft, 77ft, 87ft)	53z (68ft, 77ft, 87ft)	52z (68ft, 77ft, 87ft)	51z (68ft, 77ft, 87ft)	50z (68ft, 77ft, 87ft)
32	123.0	122.4	121.8	121.0	120.0	118.2
40	124.8	124.2	123.6	122.8	121.8	120.0
50	126.2	125.6	125.0	124.2	123.2	121.4
63	127.5	126.9	126.3	125.5	124.5	122.7
80	128.3	127.7	127.1	126.3	125.3	123.5
100	128.8	128.2	127.6	126.8	125.8	124.0
125	129.0	128.4	127.8	127.0	126.0	124.2
160	128.7	128.1	127.5	126.7	125.7	123.9
200	127.5	126.9	126.3	125.5	124.5	122.7
250	126.0	125.4	124.8	124.0	123.0	121.2
315	124.6	124.0	123.4	122.6	121.6	119.8
400	123.3	122.7	122.1	121.3	120.3	118.5
500	121.9	121.3	120.7	119.9	118.9	117.1
630	120.5	119.9	119.3	118.5	117.5	115.7
800	119.1	118.5	117.9	117.1	116.1	114.3
1000	117.8	117.2	116.6	115.8	114.8	113.0
1250	116.4	115.8	115.2	114.4	113.4	111.6
1600	115.0	114.4	113.8	113.0	112.0	110.2
2000	113.6	113.0	112.4	111.6	110.6	108.8
2500	112.3	111.7	111.1	110.3	109.3	107.5
3150	110.9	110.3	109.7	108.9	107.9	106.1
4000	109.5	108.9	108.3	107.5	106.5	104.7
5000	108.1	107.5	106.9	106.1	105.1	103.3
6300	106.8	106.2	105.6	104.8	103.8	102.0
8000	105.4	104.8	104.2	103.4	102.4	100.6
10000	104.0	103.4	102.8	102.0	101.0	99.2
OASPL (dB)	138.1	137.5	136.9	136.1	135.1	133.3
Baseline: 95% probability and 50% confidence assumes 40 to 50% fill by PLF cross-sectional area. dB ref: 20 micropascals						

Figure 3.2.2-3: Acoustic Levels near Vents for 4-m Payload Fairings



### 3.2.3 Vibration

The SC is subjected to a wide range of dynamic excitation during launch. For this reason, maximum expected flight dynamic environments are defined by the following categories: low frequency, mid-frequency, and high frequency. The low frequency environment constitutes the 0-50 Hz range, and is defined by the mission-specific Coupled Loads Analysis (CLA). The high frequency range is characterized by two environments: acoustics and shock. The transition zone between the low and high frequency is the mid-frequency range (50-100 Hz).

The low-frequency vibration tends to be the design driver for SC structure. Figure 3.2.3-1 shows the flight measured equivalent sine vibration at the SC interface for the Atlas V 400 and 500 series vehicles. The envelope shown is based on a 99% probability and 90% confidence statistical envelope with a resonant amplification factor (Q) of 20. Most peak responses occur for a few cycles during transient events, such as lift off, wind gusts, Booster Engine Cutoff (BECO), jettison events, and Centaur Main Engine Cutoff (MECO). Other flight events produce multi-cycle responses such as boundary layer turbulence (buffet), Centaur longitudinal event, and booster engine thrust oscillation.

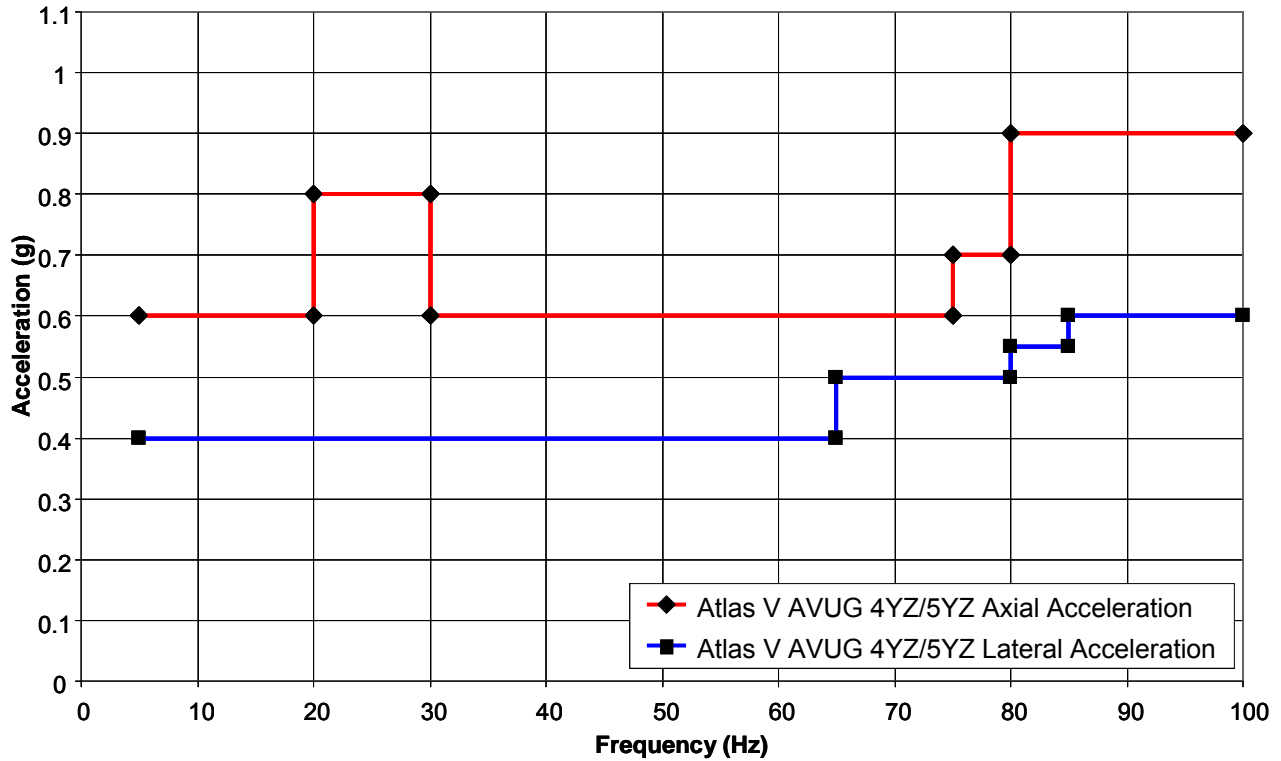
The low-frequency transient response environment during Atlas/Centaur flight is characterized by a combination of the equivalent sinusoidal vibration specified at the SC interface and Coupled Loads Analysis (CLA). Section 3.3 describes recommended vibration verification approaches. If a quasi-sinusoidal test is used for verification or assessment of the margin of safety, CLA is used to notch the test input in the 0 to 50 Hz range to maintain component responses below design levels. Notching in the 50 to 100 Hz frequency range is not recommended without technical discussion concerning flight equivalent levels as related to actual SC dynamic characteristics.

The high-frequency random vibration that the SC experiences is primarily due to the acoustic noise field, with a very small portion being mechanically transmitted through the SC interface. The acoustically excited, random vibration environment tends to be the design driver for lightweight components and small structural supports. The high-frequency vibration level will vary from one location to another depending on physical properties of each area of the SC. The exact interface levels depend on the structural characteristics of the lower portion of the SC, the particular payload adapter, and the influence of the acoustic field for the particular SC. This is because the vibration level at the payload adapter interface depends on the adjacent structure above and below the interface, Acoustic test of the SC will therefore be the most accurate simulation of the high frequency environment experienced in flight and is preferable to base input random



vibration test. If the SC is mounted to a test fixture that has structural characteristics similar to the payload adapter, then vibration levels at the interface will be similar to flight levels. To accurately reflect the flight environment, it is not recommended to attach the SC to a rigid fixture during acoustic testing. Alternate 50-100 Hz random vibration and Q=20 4-m PLF jettison SRS environments are available upon request.

**Figure 3.2.3-1: Quasi-Sinusoidal Vibration Levels for Atlas V 400 Series and Atlas V 500 Series Based on SRS with Q=20**



AVUG11\_F030203\_01c

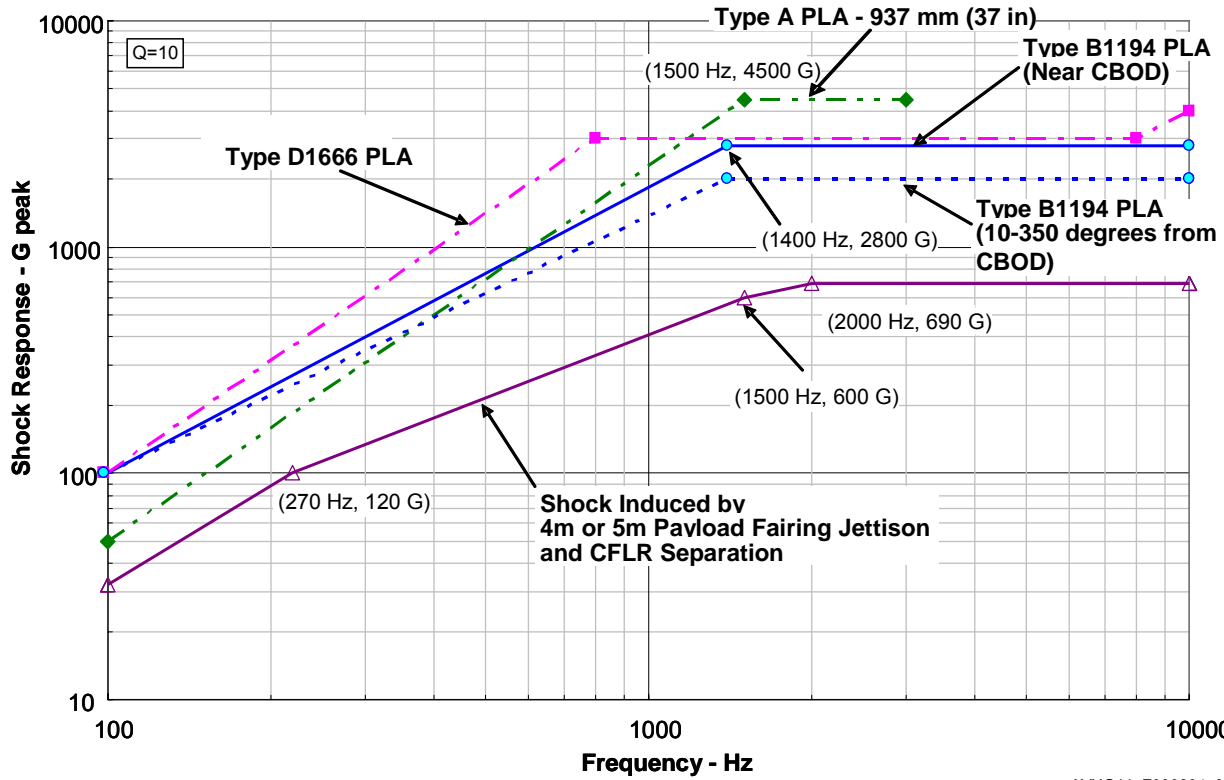
### 3.2.4 Shock

Four primary pyrotechnic shock events occur during flight on the Atlas V vehicles, which affect SC interface requirements. These events are PLF jettison, Centaur separation from the Atlas V booster, SC separation, and separation of the CFLR for the Atlas V 500 series vehicles. The CFLR provides a structural connection between the top of the Centaur and the 5-m PLF for reduced loss of clearance within the payload compartment. In general, the SC separation device generates the maximum shock environment for the SC. While the other events do produce noticeable shock, the levels are significantly lower than separation system shock due to distance attenuation.

Figure 3.2.4-1 shows the maximum expected SC separation shock levels for a typical SC at the separation plane for Atlas V standard payload adapters. The most significant shock generated by the Atlas V LV prior to SC separation is PLF jettison and CFLR separation. The shock levels for the PLF 4-m or 5-m jettison events and CFLR separation are shown on the figure for comparison. All shock environments are defined on the Atlas V LV side of the interface and represent a 95% probability and 50% confidence envelope with a resonant amplification factor (Q) of 10. Response on the SC side of the interface depends on the unique characteristics of the SC's interface structure.

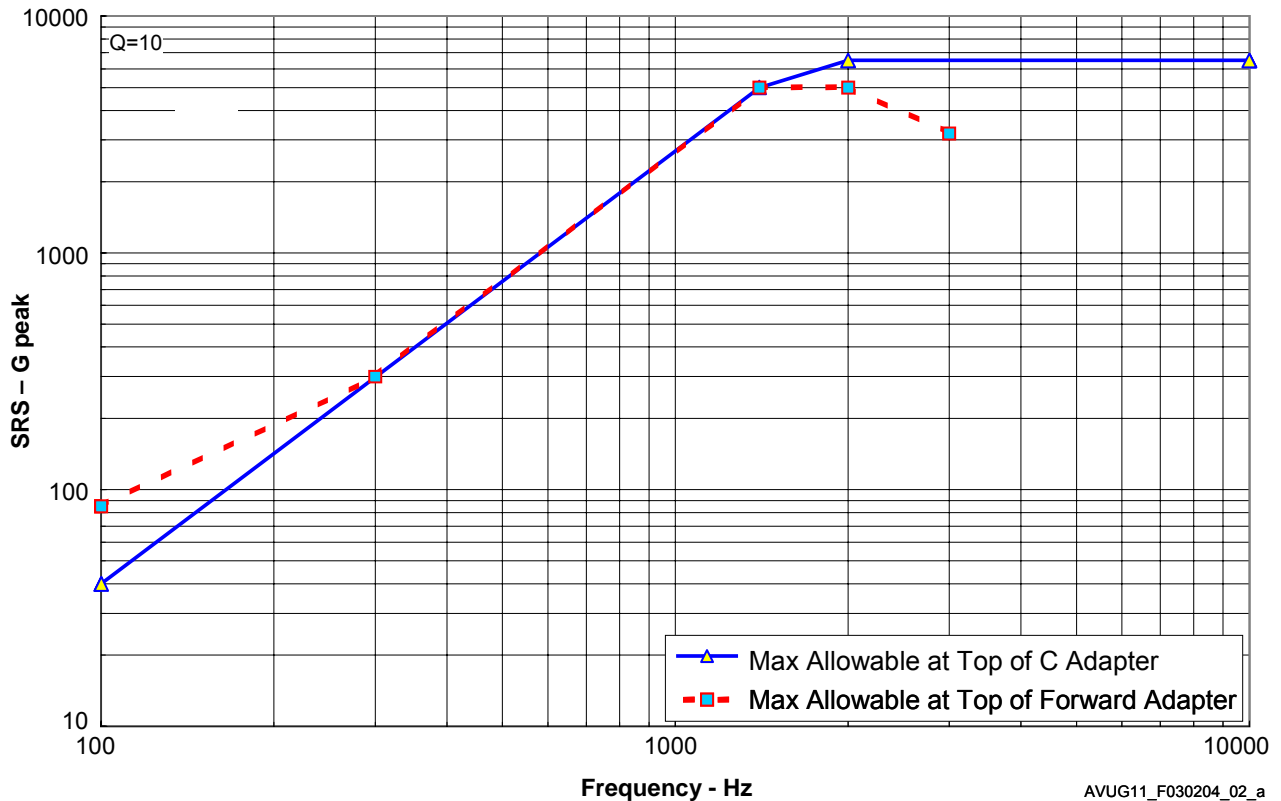
Figure 3.2.4-2 shows the maximum acceptable shock level at the top of the CFA and LV adapter interface for a customer provided payload adapter and/or separation system. This requirement is necessary to assure Atlas V LV component compatibility with SC-induced shock.

Figure 3.2.4-1: Typical Maximum Atlas Shock Levels – Atlas V Standard Payload Adapters



AVUG11\_F030204\_01\_a

Figure 3.2.4-2: Maximum Allowable Spacecraft-Produced Shock at Centaur Forward Adapter and the Top of the LV Adapter



AVUG11\_F030204\_02\_a

### 3.2.5 Thermal

**Within Payload Fairing** — The PLF protects the SC during ascent to an altitude of approximately 113,000 m (370,000 ft). Aerodynamic heating on the PLF results in a time-dependent radiant heating environment around the SC before PLF jettison. The 4-m and 5-m PLFs both use cork on the external surface to minimize PLF skin temperatures.

For the Atlas V 4-m PLF, the inner PLF bare skin surfaces of the cone and cylinder have a low emittance finish ( $\epsilon < 0.1$ ) that minimizes heat transfer to the SC. The PLF boattail and inner acoustic blanket surfaces facing the SC for the 4-m PLF have an emittance of  $\leq 0.9$  ( $\epsilon \leq 0.9$ ). The peak heat flux radiated by the 4-m PLF bare inner surfaces is less than  $394 \text{ W/m}^2$  ( $125 \text{ Btu/hr-ft}^2$ ) and peak PLF skin temperatures not covered by acoustic blankets remain below  $93^\circ\text{C}$  ( $200^\circ\text{F}$ ) at the warmest location. Inner acoustic blanket temperatures remain below  $49^\circ\text{C}$  ( $120^\circ\text{F}$ ).

For the Atlas V 5-m PLF, the SC thermal environment is attenuated by the acoustic suppression system that is baselined for the PLF cylinder and the lower portion of the ogive nose section. The inner surfaces of the bare composite 5-m PLF nose and cylinder have an emittance of 0.9. The inner surfaces of the acoustic suppression system have an emittance of  $\leq 0.1$ . The peak heat flux radiated by the inner surfaces of the bare ogive and cylinder of the 5-m PLF is less than  $536 \text{ W/m}^2$  ( $170 \text{ Btu/hr-ft}^2$ ), and peak temperatures remain below  $88^\circ\text{C}$  ( $190^\circ\text{F}$ ), at the warmest location. The inner acoustic suppression system surface temperatures for the 5-m PLF remain below  $60^\circ\text{C}$  ( $140^\circ\text{F}$ ).

**After Payload Fairing Jettison** — PLF jettison typically occurs when the 3-sigma maximum free molecular heat flux decreases to  $1,135 \text{ W/m}^2$  ( $360 \text{ Btu/hr-ft}^2$ ). PLF jettison timing can be adjusted to meet specific mission requirements. Free Molecular Heating (FMH) profiles following PLF jettison are highly dependent on the trajectory flown and are provided on a mission-unique basis. Raising the parking orbit perigee altitude can reduce peak FMH levels; however, it will have a minor negative effect on delivered LV performance.

The SC thermal environment following PLF jettison includes free molecular heating, solar heating, Earth albedo heating, Earth thermal heating, and radiation to the upper stage and to deep space. The SC also is conductively coupled to the forward end of the Centaur through the payload adapter. Solar, albedo, and Earth thermal heating can be controlled as required by specification of launch times, vehicle orientation (including rolls), and proper mission design.

For a typical 30-minute, geosynchronous transfer orbit mission, the Centaur nominally provides a benign thermal influence to the SC, with radiation environments ranging from  $-45$  to  $52^\circ\text{C}$  ( $-50$  to  $125^\circ\text{F}$ ), and interface temperatures ranging from  $0$  to  $49^\circ\text{C}$  ( $32$  to  $120^\circ\text{F}$ ) at the forward end of the payload adapter. Neither the Centaur main engine plumes nor reaction control system engine plumes provide any significant heating to the SC. The Centaur main engine plumes are non-luminous due to the high purity of  $\text{LH}_2$  and Liquid Oxygen ( $\text{LO}_2$ ) reactants.

### 3.2.6 Static Pressure (PLF Venting)

The payload compartment is vented during the ascent phase through one-way vent doors. Payload compartment pressure and depressurization rates are a function of the PLF design and trajectory.

The 4-m and the 5-m PLFs designs have a depressurization rate of no more than  $6.20 \text{ kPa/s}$  ( $0.9 \text{ psi/s}$ ). The pressure decay rate will generally be less than  $2.5 \text{ kPa/s}$  ( $0.36 \text{ psi/s}$ ), except for a short period around transonic flight when the decay rate will generally not exceed  $5.0 \text{ kPa/s}$  ( $0.73 \text{ psi/s}$ ). Typical depressurization rates are less than these values. While Figures 3.2.6-1 and 3.2.6-2 illustrate typical bounding pressure profiles and depressurization rates for the 4-m PLF, and Figures 3.2.6-3 and 3.2.6-4 illustrate typical pressure profiles and depressurization rates for the 5-m PLF, these figures are not intended for use with respect to SC venting design. Section 3.2.6.1 contains data that is appropriate for design purposes.

Figure 3.2.6-1: Typical Static Pressure Profiles inside the EPF for Atlas V 431

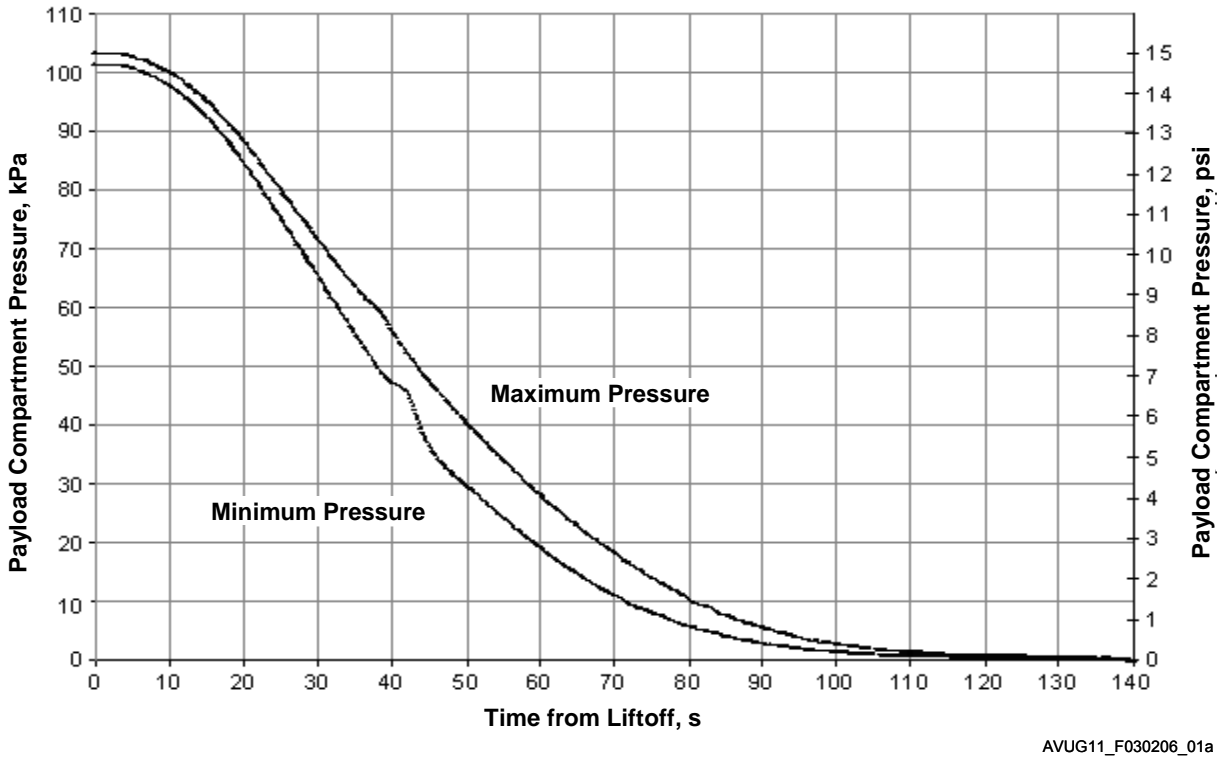


Figure 3.2.6-2: Typical Payload Compartment Pressure Decay Rate inside the EPF for Atlas V 431

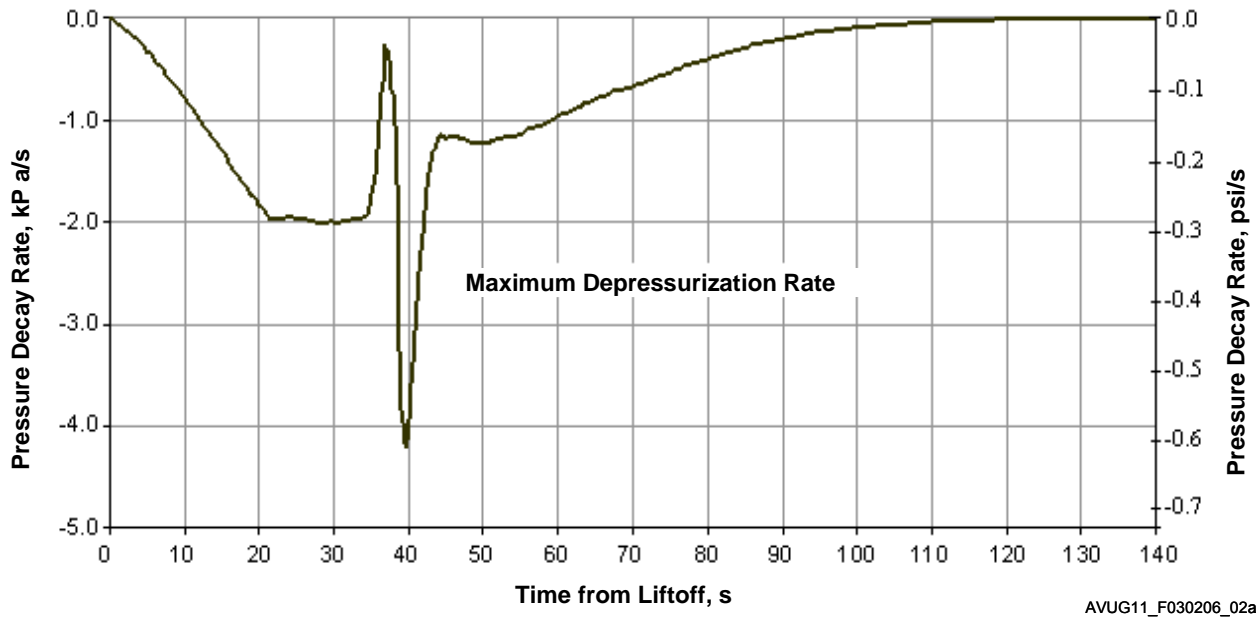


Figure 3.2.6-3: Typical Static Pressure Profiles inside the 5-m Fairing

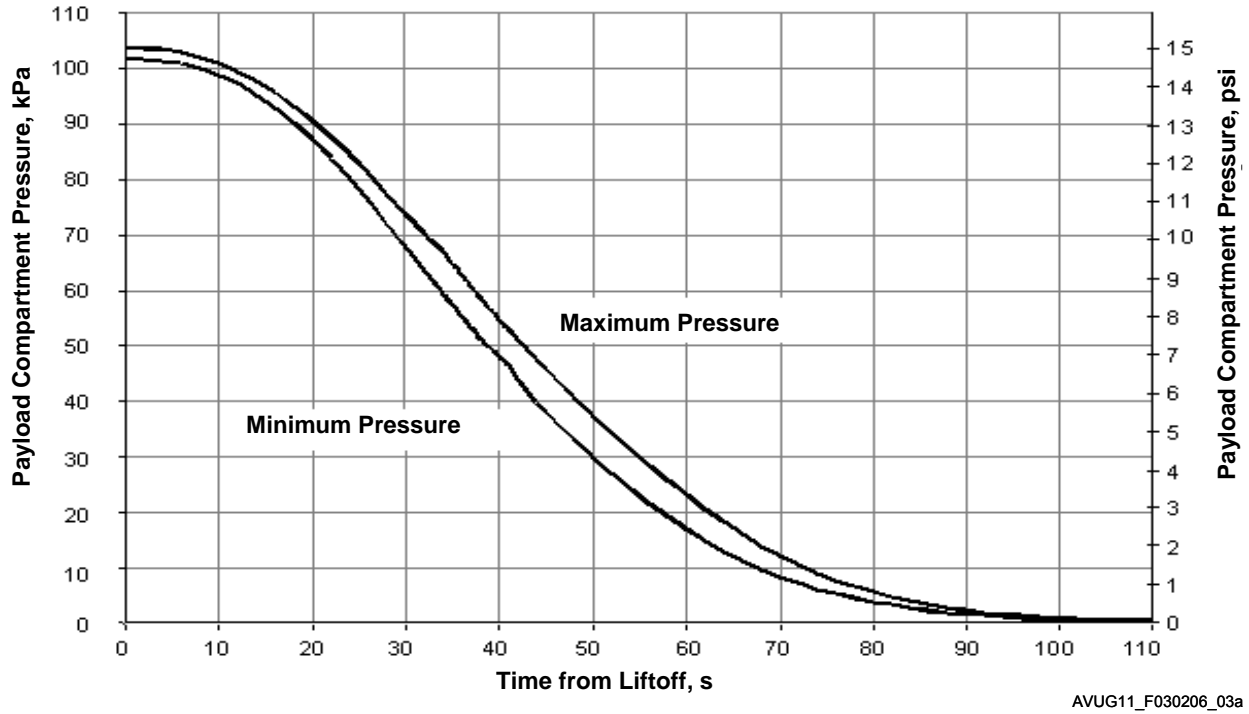
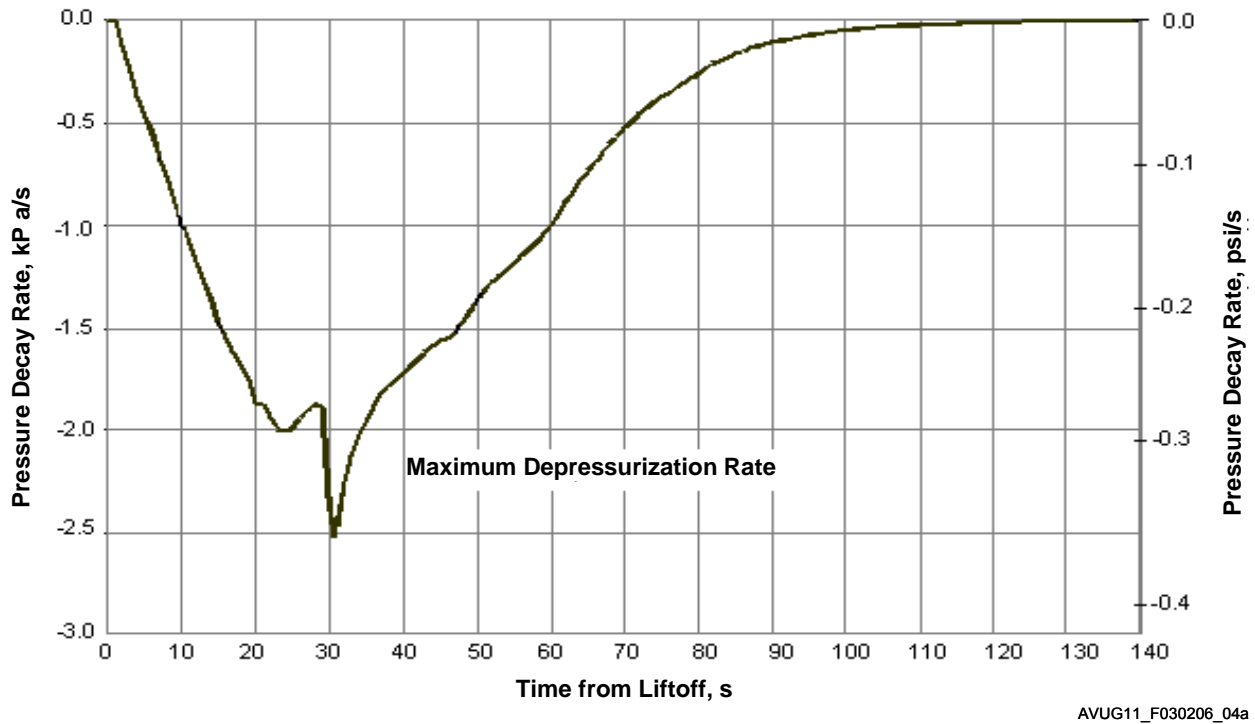


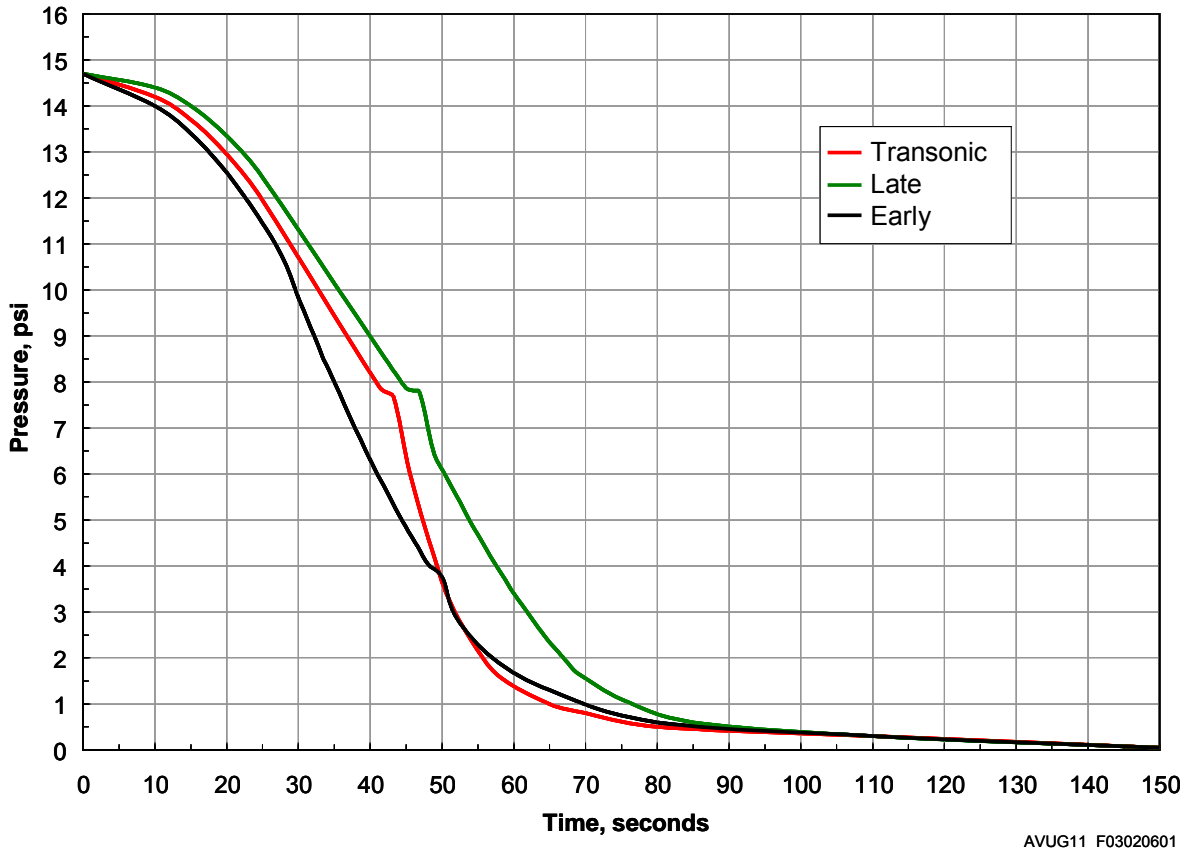
Figure 3.2.6-4: Typical Payload Compartment Pressure Decay Rate for the 5-m Fairing



### 3.2.6.1 Static Pressure (PLF Venting) Environment for Design Considerations

For SC venting design purposes, the payload compartment depressurization environment for both the 4-m and the 5-m PLF will be no more severe than as depicted in Figure 3.2.6.1-1, with the corresponding data specified in Table 3.2.6.1-1. The “transonic” profile design bounds the peak depressurization, which occurs during transonic flight. The remaining two profiles (“early” and “late”) are intended to bound longer-term venting. The use of all three curves is necessary to adequately assess the full range of flight environments.

Figure 3.2.6.1-1: Atlas V Design Time Pressure History Curves



AVUG11\_F03020601\_01a

### 3.2.7 In-flight Contamination Control

For most missions, the Atlas V launch system limits contamination depositions from all launch system sources onto SC surfaces to a molecular thickness of 150 Angstroms and a particle obscuration of 1.0%, from the start SC encapsulation operations through the end of the CCAM, which follows SC separation. Launch system ground contamination sources are addressed in Sections 3.1.3.2 and 3.1.3.3. Launch system ascent contamination sources are discussed below.

**3.2.7.1 Molecular Outgassing**

Nonmetallic materials outgas molecules that can deposit on SC surfaces. This source is limited by choosing low outgassing materials where possible and by limiting, encapsulating, or vacuum baking higher outgassing materials. Outgassing from non-metallic materials on the Centaur Forward Adapter is the single largest source of molecular contamination on the Atlas V vehicle.

**3.2.7.2 Nonvolatile Residue Redistribution**

PLF and other surfaces in the PLF volume will have small amounts of adsorbed molecules that desorb when these surfaces are warmed. They can deposit on SC surfaces that are cooler than the condensation temperature of these molecules. Atlas V hardware is cleaned and tested to less than 1 mg/ft<sup>2</sup> of nonvolatile residue redistribution (NVR).

**3.2.7.3 Particle Redistribution**

Particles on surfaces within the PLF volume can shake loose and redistribute to SC surfaces during launch and flight. This source is limited by cleaning hardware to Visibly Clean Level 2 criteria before encapsulation. The 4-m PLF is also vibrated as part of the cleaning process. Redistribution of particles from PLF surfaces during ascent is the single largest source of particle contamination on the Atlas V vehicle. Additional LV hardware cleanliness levels may be specified to meet mission unique requirements.

**3.2.7.4 Payload Fairing Separation**

The Atlas V system accomplishes separation of the 4-m PLF using pyrotechnic separation bolts and jettison springs. The pyrotechnic bolts on the PLF are located in individual cavities that isolate them from the SC. Particle production from PLF jettison springs has been tested and is negligible. The 5-m PLF halves are separated by a linear pyrotechnic separation system that is fully contained in an expandable bellows. The bellows expands forcing the shearing of a rivet line. The sheared rivets are retained by tape. SC contamination from this system is negligible based on the results of analyses and tests.

**3.2.7.5 Booster Separation**

The Atlas V booster separates from the Centaur by a frangible joint assembly and is propelled away from it by retrorockets. The following paragraphs discuss these two systems.

**Table 3.2.6.1-1: Atlas V Design Time Pressure History Data Points**

Transonic		Late		Early	
sec	psi	sec	psi	sec	psi
0.00	14.70	0.00	14.70	0.00	14.70
10.00	14.20	10.00	14.40	10.00	14.00
15.00	13.70	15.00	14.00	15.00	13.40
20.00	12.95	20.00	13.35	20.00	12.55
25.00	11.95	25.00	12.45	25.00	11.45
41.20	7.90	44.80	7.90	28.00	10.64
43.20	7.70	46.80	7.80	30.20	9.75
45.20	6.24	48.80	6.50	32.20	9.00
46.60	5.40	50.40	6.00	33.50	8.50
48.70	4.30	52.10	5.50	35.00	8.00
50.90	3.30	53.80	5.00	36.40	7.50
54.00	2.40	55.30	4.60	37.90	7.00
58.00	1.60	56.80	4.20	39.40	6.50
65.00	1.00	58.40	3.80	41.00	6.00
70.00	0.80	60.00	3.40	42.70	5.50
80.00	0.50	61.40	3.10	44.40	5.00
110.00	0.30	62.80	2.80	46.30	4.50
150.00	0.05	64.20	2.50	48.00	4.05
		65.50	2.25	50.00	3.75
		66.90	2.00	52.00	2.88
		68.00	1.80	57.00	2.00
		68.80	1.68	65.00	1.30
		75.00	1.10	80.00	0.60
		85.00	0.60	110.00	0.30
		110.00	0.30	150.00	0.05
		150.00	0.05		

### 3.2.7.5.1 Atlas V 400 Series

The Atlas V 400 series mission designs have the PLF in place on the vehicle during detonation of the booster separation system and firing of the retrorockets. PLF leak areas are small and entrance of gases through vent areas is controlled by one-way flapper doors on all PLF designs. This virtually eliminates the separation system as a contamination source since there is no credible transport path from the retrorockets to the SC.

### 3.2.7.5.2 Atlas V 500 Series and HLV

The booster is separated from Centaur with a frangible joint, similar to the PLF Horizontal Separation System (HSS), located just aft of the Centaur aft tank ring. This event occurs inside the PLF boattail that remains attached to the booster after the PLF has been jettisoned. Particles generated by frangible joint operation can be entrained in the retrorocket plume following separation of the booster and Centaur vehicles, and transported to the SC.

### 3.2.7.5.3 Booster Retrorockets

After separation, eight retrorockets located in the booster intertank compartment fire to ensure the expended booster moves away from Centaur. These eight retrorockets use solid propellants and are canted outboard. The resulting plume products consist of small solid particles and very low density gases. The boattail shields the SC from particles in the retrorocket plume. Retrorocket plume gases that expand around the boattail and impinge on the SC are rarefied and are not condensable because SC surfaces are still relatively warm from prelaunch payload compartment gas conditioning. Moderate molecular depositions can be expected on aft facing surfaces.

### 3.2.7.6 Spacecraft Separation Event

Atlas V uses two existing types of clamp band SC separation systems. An additional clamp band is in development and qualification. All three systems (1194mm, 1666mm, and the 937mm currently in development) are termed the Low Shock Payload Separation System (LSPSS) and employ a sealed pyrotechnic pin-puller to release potential energy stored as component tension to release the clamp band device. This system does not have the bolt cutter that was used in earlier Atlas missions and produces a few small particles, but no debris. Sealed pyrotechnic bolts are sometimes used for hard-point attach systems. These also produce only minor quantities of small particles.

### 3.2.7.7 Collision and Contamination Avoidance Maneuver

The Centaur Reaction Control System (RCS) consists of 12 hydrazine ( $N_2H_4$ ) thrusters for Centaur propellant settling and attitude-control requirements. Four thrusters provide axial thrust and eight provide roll, pitch, and yaw control. Thrusters are located slightly inboard on the Centaur aft bulkhead. Thrusters produce a plume that has extremely low contaminant content. Before Centaur/SC separation, the SC will not be exposed to RCS exhaust plumes. The RCS thruster's inboard location on the aft bulkhead precludes direct line of sight between the SC and thrusters. After SC separation, the Centaur executes the CCAM, which is designed to prevent recontact of the Centaur with the separated SC while minimizing contamination of the SC.

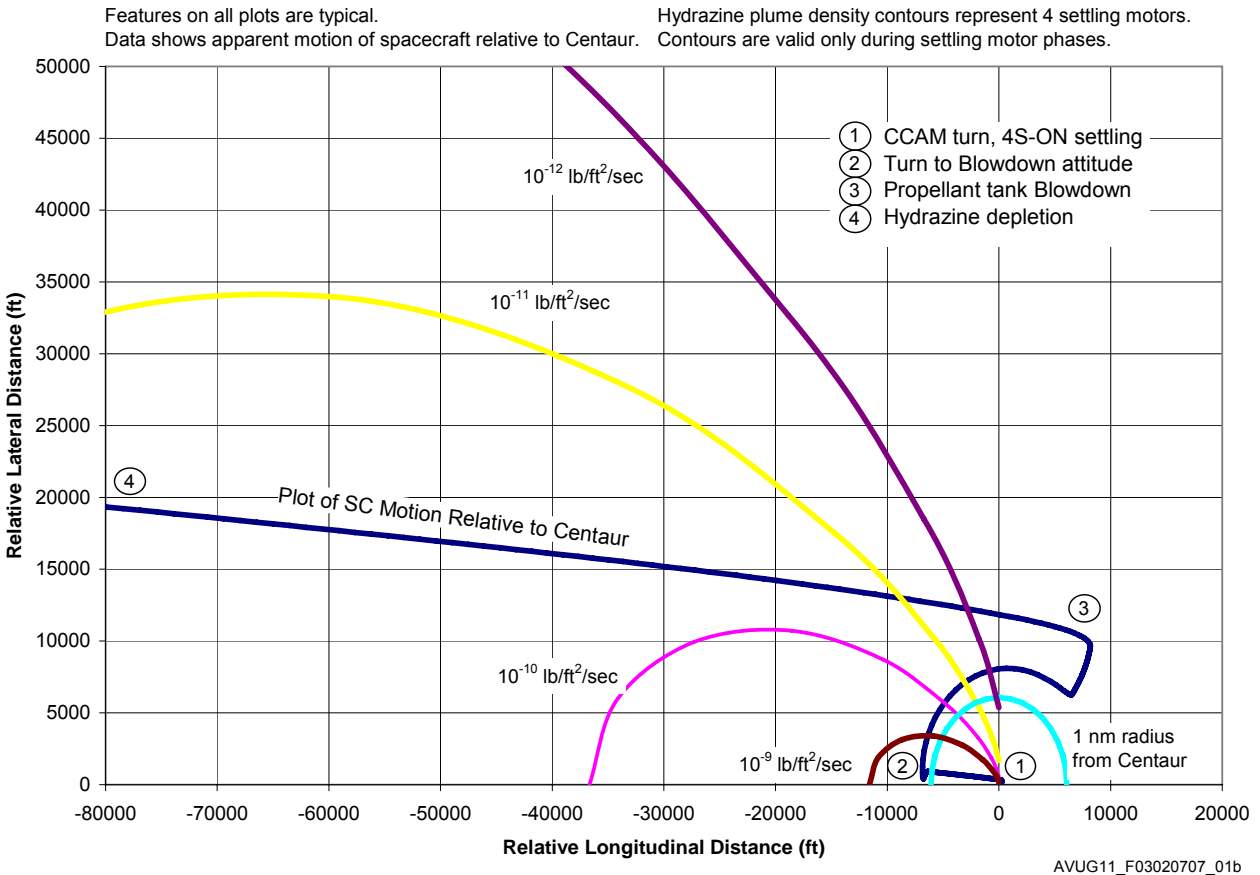
Figure 3.2.7.7-1 shows a typical CCAM sequence. This figure shows typical SC motion after the separation event as longitudinal and lateral distance from the upper stage. Included are contour lines of constant flux density for the plumes of the aft firing RCS settling motors during operation. The plumes indicate the relative rate of hydrazine exhaust product impingement on the SC during the 4S-ON (four settling motors on) phases. There is no impingement during the CCAM settling phases because the SC is forward of the settling motors.

#### 3.2.7.7.1 Orbital Debris



To minimize orbital debris, ULA evaluates and implements upper stage disposal options as part of the integration process.

**Figure 3.2.7.7-1: Typical Spacecraft Motion Relative to Centaur**



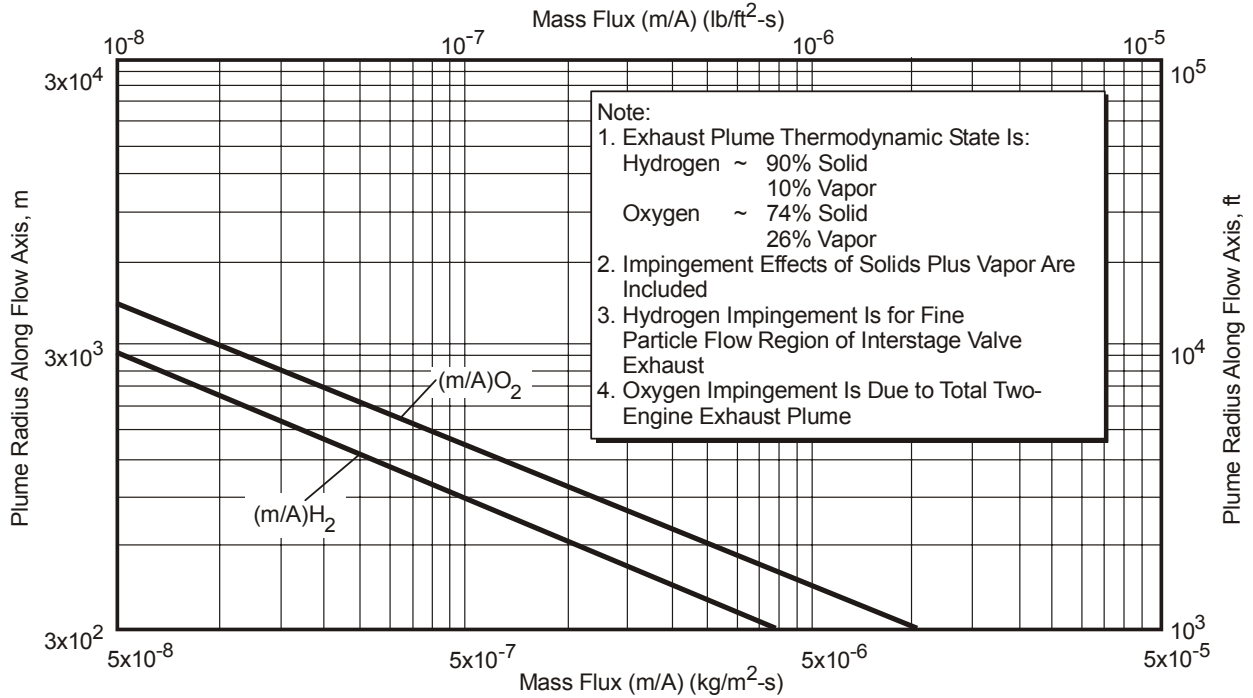
**3.2.7.8 Upper-Stage Main Engine Blowdown**

As part of the CCAM, hydrogen and oxygen are expelled through the engine system to protect the vehicle and to further increase Centaur/SC separation distance. Hydrogen is expelled out the engine cool down ducts and oxygen is expelled out the main engine bells. The expelled products are hydrogen, oxygen, and trace amounts of helium, which are non-contaminating to the SC. Main engine blow down does not begin until a relative separation distance  $\geq 1.9$  km (1.0 nmi) has been attained. Figure 3.2.7.8-1 identifies typical main engine blow down exhaust product impingement rates on the SC.

**3.2.8 Electromagnetic Environment**

The description of environments in Section 3.1.2 encompasses worst-case flight environments with some individual exceptions, which are dependent upon launch trajectory. The Atlas V program will address any individual exceedances for specific launches.

Figure 3.2.7.8-1: Typical Spacecraft Impingement Fluxes During Propellant Tank Blow Down



AVUG11\_F03020708\_01a

### 3.3 SPACECRAFT COMPATIBILITY TEST REQUIREMENTS

ULA requires that the SC be capable of experiencing maximum expected flight environments multiplied by minimum factors of safety to preclude loss of critical function. An environmental test report is required to summarize the testing performed and to document the compatibility of the SC with flight environments.

Table 3.3-1: Spacecraft Structural Tests, Margins, and Durations

The SC testing required for demonstration of compatibility is listed in Table 3.3-2. Table 3.3-1 describes structural environment test margins and durations appropriate as a minimum for programs in three phases of development. The Structural Test Model (STM) is considered a test-dedicated qualification unit with mass simulation of components to be tested in unit qualification programs. Data acquired during STM tests may be used to establish qualification levels for each component. The system level vibration test shall include wet propellant tanks for new designs if acceptance testing will not include this important effect.

Test	Qual	Protoflight	Flight
Static			
• Level	1.25 x Limit	1.25 x Limit	1.1 x Limit
• Analyses	(DLF or CLA)	(CLA)	(Proof Tests)
Acoustic			
• Level	Limit + 3 dB	Limit + 3 dB	Limit Level
• Duration	2 Min	1 Min	1 Min
Sine Vib			
• Level	1.25 x Limit	1.25 x Limit	Limit Level
• Sweep Rate	2 Oct/Min	4 Oct/Min	4 Oct/Min
Shock	1 Firing	1 Firing	1 Firing
*Note: The Protoflight test levels are also used for validation of ICD dynamic environments when supplemental FM measurements (Mission Satisfaction Option) are made for a specific mission.			

The Protoflight Model (PFM) is the first flight article produced without benefit of a qualification or STM program. The flight configured SC is exposed to qualification levels for acceptance durations. The Flight Model (FM) is defined as each flight article produced after the qualification or protoflight article. Tests required for each FM are intended as proof-of-manufacturing only and are performed at maximum expected flight levels.

Flight hardware fit checks verify mating interfaces and envelopes. Verification of SC compatibility with shock produced by separation systems provided by ULA is typically demonstrated by firing of a flight configured system following the FM fit check. This test may also be performed during STM or PFM testing to establish a mapping of shock levels for component locations near the interface. Component unit qualification testing must envelop the mapped environment. For user-supplied adapters and separation systems, ULA recommends firing of the actual separation device on a representative payload adapter and SC to measure the actual level and/or qualify the SC.

ULA requires that for SC-provided separation systems, the flight interface harness to the separation system be tested with LV flight avionics to verify end-to-end functionality. The test is preferred during the Launch Vehicle Readiness Test (LVRT), but may take place during ASOC testing if required to meet SC integration schedules.

**Table 3.3-2: Spacecraft Qualification and Acceptance Test Requirements**

	Acoustic	Shock	LV IF Vibration	EMI/EMC	Modal Survey	Static Loads	Fit Check
Qual	X	X	X	X	X	X	
Accept	X		X				X

ULA also suggests that the SC contractor demonstrate the SC capability to withstand thermal and EMI/EMC environments.

Intentionally Left Blank

## 4. MISSION INTEGRATION AND SAFETY

### 4.1 INTEGRATION MANAGEMENT

Clear communication between spacecraft (SC) and launch vehicle (LV) contractors is vital to mission success. The Atlas V program has established procedures and interfaces to delineate areas of responsibility and authority.

The mission integration and management process defined in this section has been used successfully on both commercial and government Atlas V program missions. The standard integration period is 24 months. The following sections discuss roles and responsibilities, and define integration and safety requirements and processes.

#### 4.1.1 Launch Vehicle Responsibilities

ULA is responsible for Atlas V design, manufacture, integration, checkout, and launch. This work takes place at ULA facilities in Denver, CO; San Diego, CA; Harlingen, TX; Decatur, AL; CCAFS, FL; and VAFB, CA. Major subcontractors include Pratt & Whitney (Centaur main engines and Atlas V booster engines), Honeywell (inertial navigation unit), Ruag (400-ISA, 5-m payload fairings and separation systems), and Aerojet (solid rocket boosters). ULA is responsible for SC integration, including electrical, mechanical, environmental, and electromagnetic compatibilities; guidance system integration; mission analysis; software design; Range Safety documentation and support; and launch site processing and coordination.

#### 4.1.2 Spacecraft Responsibilities

Since each SC mission has unique requirements, ULA encourages its Atlas V customers to discuss their particular needs directly with us. Section 4.5, Spacecraft Data Requirements, can be used as a guide to initiate dialog. Shaded items in Section 4.5 should be used as the basis for the first meeting between ULA and the customer to assist in determining SC and LV compatibility.

Customers are encouraged to contact ULA to verify the latest launch information, including:

1. Hardware status and plans
2. Launch and launch complex schedules
3. Hardware production schedule and costs

#### 4.1.3 Mission Management and Integration

The Customer Program Office (CPO) provides the mission management and primary customer interface functions for ULA. Within the CPO are four distinct offices, each headed by a Customer Program Manager (CPM). The four CPMs focus on mission management for the US Air Force (USAF); the National Reconnaissance Office, Office of Space Launch (NRO/OSL); NASA; and commercial missions, respectively. A Mission Manager is assigned from within one of these offices to represent each mission and the customer within ULA. The Mission Manager has full accountability for the successful execution of the specific launch services contract and is responsible for all programmatic activities associated with the mission.

Technical integration for a specific Atlas V mission is the responsibility of the Engineering Integration Manager (EIM), assigned by the ULA Systems Integration and Analysis organization. The EIM focuses on engineering integration of the mission SC with the Atlas V LV (which includes requirements development, oversight of analyses and design development, insight into test activities and hardware development, and delivery), development of the Interface Control Document (ICD), tracking of action items, and coordination of technical requirements across engineering disciplines.

To provide maximum efficiency in managing the many launch site operations, ULA assigns a Payload Integrator resident at the launch site to each mission. The Payload Integrator is responsible for the development, integration, and installation of all SC mission-unique items at the launch site and provides direct customer support following arrival of the SC at the launch site.

For commercial Atlas V missions, Lockheed Martin Commercial Launch Services (LMCLS) assigns a Program Director. The CLS Program Director serves as the primary interface with the commercial customer and subcontracts launch services from ULA. The CLS Program Director works closely with the ULA Mission Integration Team (MIT) to ensure all customer requirements are met.

The approach of using a customer-focused MIT consisting of the Mission Manager, EIM, Payload Integrator, and in the case of commercial missions, CLS Program Director, has proven effective over dozens of Atlas missions. This team ensures on-time delivery of hardware and software, manages mission-unique and launch readiness reviews, and coordinates mission requirements with other areas of the broader Atlas Program. This team strives to satisfy all customer needs and keep the customer informed on the status of the Atlas Program's implementation of the mission specific launch service.

#### **4.1.4 Integration Program Reviews**

Integration program reviews focus management attention on significant milestones during the launch system design and launch preparation process. As with working group meetings, these reviews can be tailored to customer requirements; however, for a first-of-a-kind launch, they may include a leading-edge design review, a mission peculiar design review, and a launch readiness review. For typical commercial communication SC launches, only one design review is required. Additionally, Program Management Reviews take place periodically to provide status.

ULA schedules launch system meetings and reviews according to the mission integration schedule. SC customer representatives may have access to ULA facilities to attend reviews, meetings, and related activities. The incremental launch preparation review process provides management with an assessment of the readiness of the LV systems to proceed with launch preparation, and assurance that all mission functional and support elements are ready to support Range Safety, countdown, and launch activities. The program-level review process is the primary mechanism to provide the management visibility required to establish maximum confidence in mission success for Atlas V launch systems.

Technical working group meetings take place at during the mission integration effort to define technical interfaces and resolve technical issues. At a minimum, technical meetings include a kick-off meeting, Mission Peculiar Design Review (MPDR), Ground Operations Working Group (GOWG), Systems Review, Ground Operations Readiness Review (GORR), and Launch Readiness Review (LRR).

##### **4.1.4.1 Mission Peculiar Design Review**

ULA has significant experience with most commercial SC contractors and finds that in the majority of cases one Mission Peculiar Design Review (MPDR) is sufficient to successfully review compliance of the mission design to the SC mission requirements. At approximately launch minus 6 months, ULA conducts the MPDR to ensure that customer requirements have been correctly and completely identified and that integration analyses and designs meet these requirements. ULA prepares and presents the review with participation from the SC contractor, launch services customer, and LV management.

For missions that require unique SC interfaces with the LV or possess mission-unique design requirements, ULA may propose two design reviews after discussions with the launch services customer and SC contractor.

The MPDR typically includes the following subjects:

1. Requirements updated since the mission integration kick-off meeting

2. Mission design, performance capability, and margin results
3. Coupled loads analysis results summary
4. Integrated thermal analysis results
5. SC separation analysis results and control system (autopilot) design
6. Guidance system accuracy analysis preliminary results
7. Mission-unique flight software and parameter implementation and design updates (if required)
8. Preliminary radio frequency compatibility analysis, electromagnetic interference/electromagnetic compatibility analysis, and link margin analysis results
9. Mission-unique electrical and mechanical interface hardware design
10. Launch site implementation of unique requirements
11. Mission-unique range asset requirement summary
12. Range Safety documentation submittal status
13. Venting analysis
14. Contamination assessment
15. Environmental control system

#### **4.1.4.2 Ground Operations Working Group**

The Ground Operations Working Group (GOWG) meeting takes place at the launch site during the early part of the standard integration cycle. The GOWG includes representatives of the SC customer, contractors, and all launch site organizations involved in operations. The GOWG provides a forum for coordinating launch site activities and resolving operational issues and concerns. It is usually co-chaired by the launch site payload integrator and the SC customer launch operations lead. At the GOWG, the following items are coordinated: the ground operations activities flow, operational timeline modifications for mission-unique SC operational considerations, ICD interface requirements definition for launch site facilities and ground support equipment, hazardous operations with the Range, and ground test requirements. The GOWG reviews and approves the system documentation, operational timelines, and operational procedures required to process, test, and launch the integrated Atlas V LV. The GOWG may be waived for SC customers with nearly identical SC (follow-on) and who are familiar with Atlas V site processing. Please see section 7.4 for more detail on launch site processing.

#### **4.1.4.3 Ground Operations Readiness Review**

The Ground Operations Readiness Review (GORR) takes place just before the arrival of the SC at the launch site processing facility. The meeting objectives are to formally kickoff the launch campaign; review the readiness of the facility to receive the SC; and ensure that processing plans, schedules, procedures, and support requirements are coordinated. The technical chairperson is the launch site payload integrator, who is responsible for documenting meeting minutes and action items. A poll at the conclusion of the meeting ensures that all participating agencies, including SC customer representatives, concur with the plan to be implemented for the launch campaign.

#### 4.1.4.4 Launch Readiness Review

The Launch Readiness Review (LRR), conducted approximately 2 days before launch, provides a final prelaunch assessment of the integrated SC/LV system and launch facility readiness. The LRR provides the forum for final assessment of all launch system preparations and contractors' individual certifications of launch readiness. The purpose of the LRR is to ensure that SC systems, LV systems, facilities and Ground Support Equipment (GSE), and all supporting organizations are ready and committed to support the final launch preparations, countdown, and launch. ULA management representatives from Denver, CO and the launch site participate in the LRR, along with representatives from SC customer organizations. Representatives from each key organization summarize their preparations and rationale for their readiness to proceed with the final launch preparations and countdown. The meeting concludes with a poll of each organization to express their readiness and commitment to launch.

#### 4.1.5 Integration Control Documentation

##### 4.1.5.1 Mission Integration Schedule

ULA prepares this top-level schedule and the Mission Integration Team (MIT) monitors it. It maintains visibility and control of all major program milestone requirements, including working group meetings, major integrated reviews, design and analysis requirements, and major launch operations tests. It is developed from tasks and schedule requirements that are identified during initial integration meetings and is used by all participating organizations and working groups to develop and update sub-tier schedules. The mission integration schedule facilitates a systematic process to manage program activities. The mission integration schedule tracks and monitors the mission progress to avoid significant schedule issues and possible cost impacts. The mission integration schedule contains sufficient mission details and contractual milestones to assist the Mission Manager and the EIM in managing the launch service.

##### 4.1.5.2 Interface Requirements Documents

The customer provides the SC Interface Requirements Document (IRD) to define technical and functional requirements imposed by the SC on the LV system. The document contains applicable SC data identified in Section 4.5. Information typically includes:

1. Mission Requirements — Including orbit parameters, launch window parameters, separation functions, and any special trajectory requirements, such as thermal maneuvers and separation over a telemetry and tracking ground station;
2. Spacecraft Characteristics — Including physical envelope, mass properties, dynamic characteristics, contamination requirements, acoustic and shock requirements, thermal requirements, and any special safety issues;
3. Mechanical and Electrical Interfaces — Including SC mounting constraints, SC access requirements, umbilical power, command and telemetry, electrical bonding, and electromagnetic compatibility requirements;
4. Mechanical and Electrical Requirements for Ground Equipment and Facilities — Including SC handling equipment, checkout and support services, prelaunch and launch environmental requirements, SC gases and propellants, SC Radio Frequency (RF) power, and monitor and control requirements;
5. Test Operations — Including SC integrated testing, countdown operations, and checkout/launch support.



### 4.1.5.3 Interface Control Document

The Interface Control Document (ICD) defines SC-to-LV and launch complex interfaces. The ICD documents all mission interface requirements. ULA prepares the ICD and maintains configuration control after formal signoff. It contains appropriate technical and functional requirements specified in the IRD and any additional requirements developed during the integration process. The ICD supersedes the IRD and is approved with a signature from Atlas V program management and the launch service customer. Subsequent changes to the mission ICD require formal agreement of all signing parties. If any conflict or inconsistency exists between the signed mission ICD and the IRD or the contract SOW, the signed mission ICD is given precedence.

The EIM leads the ICD technical development with management decisions coordinated with the mission manager. The ICD is the top-level interface requirements document between the LV and SC. It contains physical, functional, environmental, operational, and performance requirements for the interface and is a contractually binding document. The document establishes how each interface requirement is to be verified to ensure that all interface details have been accomplished in compliance with ICD requirements. It identifies interface verification activities that link the designed, built, and tested interface back to the functional and performance requirements.

## 4.2 MISSION INTEGRATION ANALYSIS

ULA performs the analyses summarized in Table 4.2-1 to support a commercial and government missions. This table represents standard integration analyses and indicates the specific output of analyses to be performed, required SC data, the nominal time during the integration cycle when the analysis is to be completed, and the application of analyses to first-of-a-kind and follow-on missions. In this context, a follow-on mission is an exact copy of a previous mission, with no change to functional requirements or physical interfaces. For a follow-on mission, all analyses are reassessed to ensure the original analysis is still applicable. For many missions, ULA uses generic versions of these analyses that bound most missions such that mission unique versions may not be required.

Figure 4.2-1 is the generic schedule for a typical commercial Atlas V mission. Figure 4.2-2 is the schedule for a typical government Atlas V mission. The typical integration process for both begins at approximately L-24 months. A schedule specific to each Atlas V mission is presented at the mission kickoff meeting.

### 4.2.1 Coupled Loads Analysis

During the integration process, ULA utilizes a set of test-correlated; flight verified three-dimensional (3D) analytical LV models for the mission-unique dynamic Coupled Loads Analysis (CLA). ULA performs mission-unique analyses where LV and SC parameters may be affected (Section 3.2.1). ULA runs a mission CLA for all mission configuration-critical flight events. Typical events in a CLA analysis include the following:

1. SC loading for critical flight events: liftoff, transonic buffet and gust, maximum dynamic pressure buffet and gust, Solid Rocket Booster (SRB) ignition, SRB jettison, Booster Engine Cutoff (BECO), maximum g-loading, Booster Engine Thrust Oscillation (BETO), Centaur Main Engine Cutoff (MECO), and Centaur Longitudinal Event (CLE)
2. Flight wind launch availability assessment
3. Payload Fairing (PLF) jettison evaluation applicable to a mission SC
4. SC loss of clearance evaluation for all critical flight events

Analysis of all events uses state-of-the-art finite element models of the booster coupled with a customer-supplied dynamic math model of the SC.

Figure 4.2-1: Twenty-Four Month Generic Commercial Mission Integration Schedule

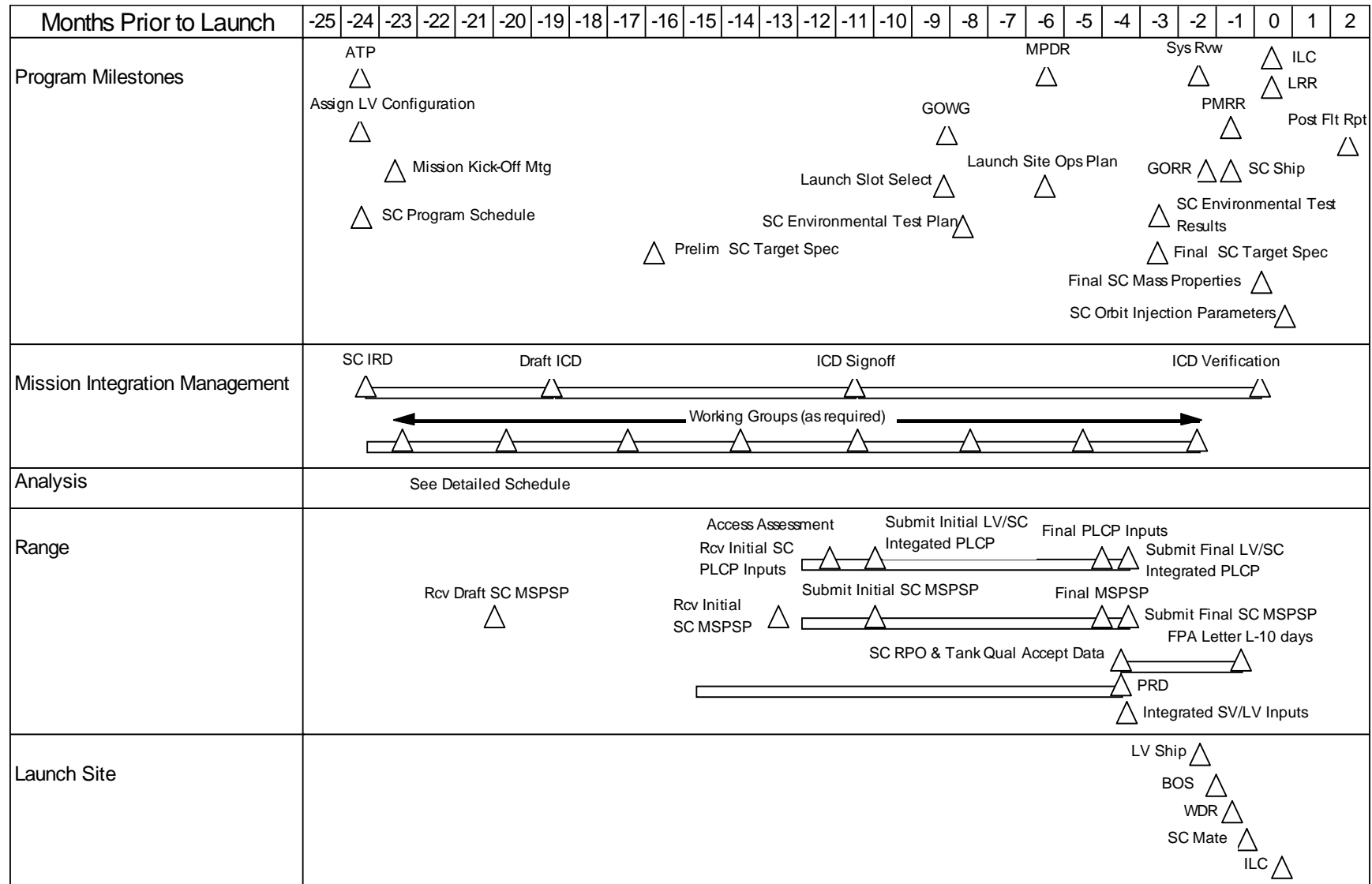


Figure 4.2-2: Twenty-Four Month Generic Government Mission Integration Schedule

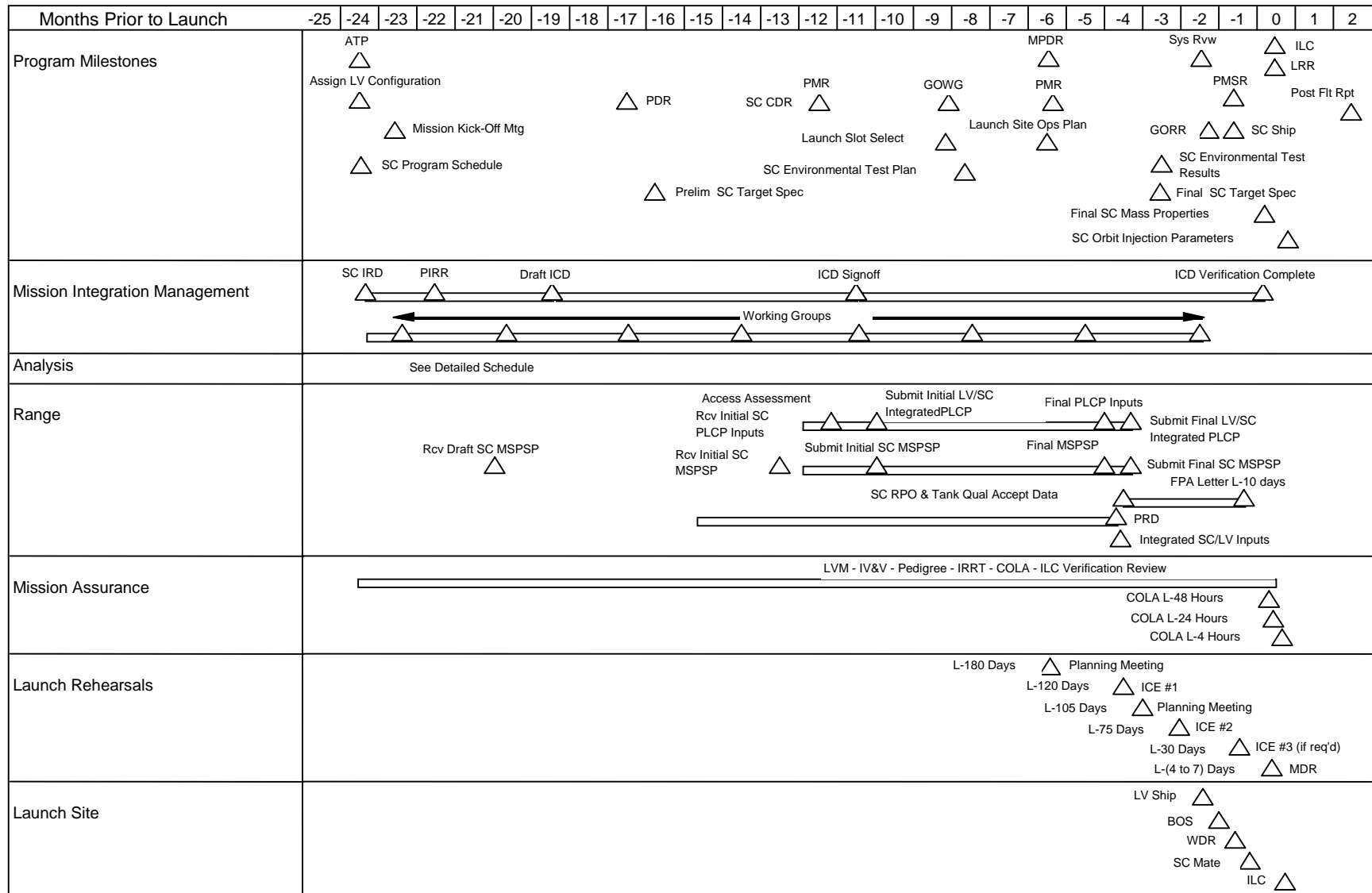


Table 4.2-1: Summary of Typical Commercial and Government Atlas V Mission Integration Analyses

Analysis	SC Data	Analysis Products	No. of Cycles		Schedule	First-of-a-Kind	Follow-on
			USG	Commercial			
1. Coupled Loads	SC Dynamic Math Model	<ul style="list-style-type: none"> <li>Spacecraft Loads</li> <li>Dynamic Loss of Clearance</li> <li>Launch Availability</li> <li>PLF Jettison Evaluation</li> </ul>	3	2	Model Delivery + 4 months	X	
2. Integrated Thermal	SC Geometric & Thermal Math Models & Power Dissipation Profile	<ul style="list-style-type: none"> <li>Spacecraft Component Temperatures</li> </ul>	1	1	Model Delivery + 6 months	X	
3. PLF Venting	SC Venting Volume	<ul style="list-style-type: none"> <li>Pressure Profiles</li> <li>Depressurization Rates</li> </ul>	1	1	SC Data + 2 months	X	
4. Critical Clearance	SC Geometric Model; SC Dynamic Model	<ul style="list-style-type: none"> <li>SC-to-PLF Loss of Clearance (Dynamic + Static)</li> </ul>	3	2	SC Model Delivery + 4 months	X	
5. Spacecraft Separation & Clearance	SC Mass Properties	<ul style="list-style-type: none"> <li>SC Sep Clearance</li> <li>SC Sep Attitude, Rate &amp; Spin-Up Verification</li> </ul>	1	1	Design Review	X	
6. Post Separation Clearance		<ul style="list-style-type: none"> <li>LV-SC Separation History</li> </ul>	1	1	Design Review	X	
7. Pyro Shock	SC Interface Definition	<ul style="list-style-type: none"> <li>SC Shock Environment</li> </ul>	1	1	Design Review	X	
8. Acoustics	SC Geometry Fill Factors	<ul style="list-style-type: none"> <li>SC Acoustics Environment</li> </ul>	1	1	Design Review	X	
9. LV Induced Interface Vibration	SC Test Plan	<ul style="list-style-type: none"> <li>SC Interface Vibration Environment</li> </ul>	1	1	Design Review	X	
10. EMI/EMC	SC Radiated Emissions Curve SC Radiated Susceptibility Curve SC Rec Op & Damage Thresholds SC Diplexer Rejection SC Transmitter Characteristics	<ul style="list-style-type: none"> <li>Preliminary assessment of Margins</li> <li>Integrated EMI/EMC Preliminary Analysis</li> <li>Final version of the Above Two Analyses</li> </ul>	2	2	Design Review & Again at L-2 months	X	X (1 Cycle)

Analysis	SC Data	Analysis Products	No. of Cycles		Schedule	First-of-a-Kind	Follow-on
			USG	Commercial			
11. Contamination	SC Contamination Limits for Sensitive, Critical, Vertical & Horizontal Surfaces SC Geometric & Thermal Math Model	<ul style="list-style-type: none"> <li>Contamination Analysis or Contamination Assessment</li> </ul>	1	1	Design Review	X	
12. RF Link Compatibility & Telemetry Coverage (Airborne)	SC Transmitter Characteristics SC Receiver Characteristics Receiver Preselector & IF Filter Characteristics	<ul style="list-style-type: none"> <li>Link Margins</li> <li>Frequency Compatibility</li> <li>EEDs Susceptibility</li> </ul>	1	1	Design Review	X	X
13. RF Link Compatibility & Telemetry Coverage (Ground)	SC Transmitter & Receiver Characteristics	<ul style="list-style-type: none"> <li>Link Margins</li> <li>Identify Required Hardware</li> </ul>	1	1	Design Review	X	X
14. Performance	SC Mass & Mission Requirements Definition	<ul style="list-style-type: none"> <li>Config, Performance &amp; Weight Status Report</li> <li>Performance Margin</li> </ul>	3	2	ATP + 3 months, Final Targeting	X	X (1 Cycle)
15. Stability	SC Model	<ul style="list-style-type: none"> <li>Control System Margins</li> <li>RCS Use</li> </ul>	1	1	L-2 month	X	
16. Mass Properties	SC Mass Properties	<ul style="list-style-type: none"> <li>Mass Properties of Launch Vehicle</li> </ul>	3	3	Coincident w/Perf Reports	X	X (1 Cycle)
17. Trajectory Analysis	SC Mass & Mission Rqmts Definition	<ul style="list-style-type: none"> <li>LV Ref Trajectory</li> <li>Performance Margin</li> </ul>	1	1	Design Review	X	X
18. Guidance Analysis	Mission Requirements	<ul style="list-style-type: none"> <li>Guidance S/W Algorithms</li> <li>Mission Targeting Capability &amp; Accuracies</li> </ul>	3	2	Design Review	X	
19. Injection Accuracy	Mission Requirements	<ul style="list-style-type: none"> <li>LV System Orbit Injection Accuracy</li> </ul>	1	1	Design Review	X	
20. Launch Window	Window Definition and constraints	<ul style="list-style-type: none"> <li>Window Durations</li> </ul>	1	1	Design Review	X	X
21. Wind Placard	SC Mass Properties	<ul style="list-style-type: none"> <li>LV Ground &amp; Flight Winds Restrictions</li> </ul>	1	1	Design Review	X	
22. Range Safety	SC Breakup Data & Propulsion Characteristics	<ul style="list-style-type: none"> <li>Trajectory Data &amp; Tapes for Range Approval</li> </ul>	2	2	L-1 year, Preliminary L-60 days, Final	X	

Analysis	SC Data	Analysis Products	No. of Cycles		Schedule	First-of-a-Kind	Follow-on
			USG	Commercial			
23. Electrical Compatibility	Electrical Interface Requirements	<ul style="list-style-type: none"> <li>End-to-End Circuit Analysis</li> </ul>	1	1	Design Review	X	
24. Post-Flight		<ul style="list-style-type: none"> <li>Evaluation of Mission Data, LV Performance &amp; Environment</li> </ul>	1	1	L + 60/days	X	X
25. Destruct System	SC Safety Data	<ul style="list-style-type: none"> <li>Confirmation of Meeting Range Safety Requirements</li> </ul>	1	1	Design Review	X	
26. Mission Targeting	Orbit Requirements	<ul style="list-style-type: none"> <li>Flight Parameter Load</li> <li>Firing Tables</li> </ul>	1	1	L-1 month	X	X
27. Flight Software	Mission Requirements	<ul style="list-style-type: none"> <li>FCS Software</li> </ul>	1	1	L-3 weeks	X	X

**4.2.2 Thermal Analyses — Preflight and Flight**

ULA performs an integrated LV/SC analysis of thermal environments imposed on the SC under prelaunch conditions and for flight mission phases up to SC separation. The Integrated Thermal Analysis (ITA) occurs with customer-supplied SC geometric and thermal math models and a detailed SC power dissipation timeline. ULA provides the results to the customer for evaluation and can be used to design thermal interfaces and mission operations to maintain predicted SC temperatures within allowable limits.

In addition to the ITA, ULA performs PLF aeroheating analyses, PLF gas conditioning analyses, and free molecular heating analyses to verify compliance with customer ICD thermal requirements and thermal requirements derived from the ITA.

Thermal analyses ensure that vehicle design and the mission trajectory are compatible with and have adequate margins over proposed SC thermal constraints. Analyses include assessment of vehicle aeroheating, PLF surface temperature ranges, maximum and minimum prelaunch air conditioning temperatures, and SC-to-Centaur interface temperature ranges.

The gas conditioning thermal analysis predicts inlet gas temperatures versus outside ambient temperatures that meet SC internal PLF gas temperature and relative humidity requirements.

PLF internal surface temperature ranges are predicted by analyzing flight aerodynamic heating.

PLF jettison time is established by software to meet the SC free molecular heating constraint. Atlas V missions ensure a benign SC thermal environment by determining jettison time based on a flight program calculation of 3-sigma maximum free molecular heating during flight.

**4.2.3 PLF Venting Analysis (Ascent Phase) and Flow Impingement Velocities**

ULA performs a PLF venting analysis to determine mission-unique pressure profiles in the payload compartment during LV ascent. Existing models that have been validated with flight data are used for this analysis. The analysis incorporates the customer-provided SC venting configuration and any mission-specific PLF requirements (e.g., thermal shields). Analysis outputs provided to the customer include PLF pressure profiles and depressurization rates as a function of flight time.

Prelaunch SC gas velocity analyses verify that impingement velocities are compatible with the defined SC. ULA performs a worst-case analysis (using the maximum air conditioning supply rate) to determine flow conditions inside the PLF.

#### 4.2.4 Critical Clearance Analysis (Loss of Clearance)

The static payload envelope defines the usable volume for a SC. This envelope represents the maximum allowable SC static dimensions (including manufacturing tolerances) relative to the SC and payload adapter interface. For clearances between the SC and PLF, the primary clearance concerns are for dynamic deflections of the SC and PLF and the resulting relative loss of clearance between these components. A critical clearance analysis is performed to verify that these deflections do not result in contact between the SC and LV hardware. This analysis considers SC and PLF static tolerances and misalignments, dynamic deflections, and out-of-tolerance conditions, and ensures that a minimum 25-mm (1-in.) clearance between the SC and the PLF is maintained. During this analysis, dynamic deflections are calculated for ground handling, flight (from the coupled dynamic loads analysis, Section 4.2.1), and PLF jettison conditions. Clearance layouts and analyses are performed for each SC configuration, and if necessary, critical clearance locations are measured after the SC is encapsulated inside the PLF to ensure positive clearance during flight.

#### 4.2.5 Spacecraft Separation Analysis

Extensive Monte Carlo analysis of pre-separation dynamics, using a 3-Degrees-Of-Freedom (DOF) simulation of the vehicle and attitude control system, demonstrates compliance with all SC attitude pointing and angular rate and spin rate requirements under nominal and 3-sigma dispersions.

Spacecraft should provide a detailed description of spacecraft operational considerations (deployments, RF system activation etc.) in the proximity of the separation event to ULA to ensure compatibility with launch vehicle sequencing and operations.

A two-body, 6-DOF Monte Carlo simulation of the Centaur and SC separation event occurs using finalized SC mass properties to verify the Centaur will not recontact the SC after separation system release. This analysis demonstrates minimum relative separation velocity, ensuring that adequate separation distance before initiating post separation Centaur maneuvers.

#### 4.2.6 Spacecraft Post Separation Clearance Analysis

After the SC has separated from the Centaur vehicle, the Centaur performs a Collision and Contamination Avoidance Maneuver (CCAM). The Centaur Reaction Control System (RCS) uses 12 hydrazine thrusters. Four thrusters are dedicated to propellant settling (axial) control and eight are allocated to roll, pitch, and yaw control. Thrusters are located on the aft bulkhead of the Liquid Oxygen (LO<sub>2</sub>) tank inboard of the 3.0-m (10-ft) tank diameter. Before SC separation, this location precludes a direct line of impingement to the SC. In addition, thrust directions are either 90 degrees or 180 degrees away from the SC.

The CCAM design positively precludes physical recontact with the SC and eliminates the possibility of significant impingement of Centaur effluents on the SC. The CCAM consists of two or three attitude maneuvers, combined with axial thrust from the RCS settling motors and blowdown of the Centaur tanks. For Atlas V vehicles, shortly after SC separation, the Centaur typically turns 50 degrees from the separation attitude and activates the settling motors to impart a  $\Delta V$  to move the Centaur a significant distance from the SC. This maneuver minimizes any plume flux to the SC and turns the Centaur normal to the flight plane. In this attitude, the tank blow down is executed at approximately 1.8 km (1 nmi) from the SC. This CCAM sequence ensures adequate in-plane and out-of-plane separation between the Centaur and the SC and minimizes the RCS motor plume flux at the SC.

#### 4.2.7 Pyroshock Analysis

The maximum SC pyroshock environment occurs at the SC separation event. PLF separation and Atlas/Centaur separation are also significant events, but the distances of the shock sources from the SC/Centaur interface make them less severe for the SC than activation of the Payload Separation System (PSS). Verification of this environment is accomplished with ground testing and flight data of existing separation systems.

#### 4.2.8 Acoustic Analysis

Analysis of the acoustic environment of the payload compartment includes effects of noise reduction of the PLF and payload fill factors and mission unique trajectory design. Verification includes the most current and applicable flight data and ground acoustic testing of representative PLF/SC configurations.

#### 4.2.9 Launch Vehicle Induced Interface Vibration

LV induced interface vibration characterizes significant mechanically induced flight events such engine start-ups, shutdown transients, staging, lift-off, transonic, maximum dynamic pressure, and maximum acceleration. Verification is accomplished using the most current set of applicable flight data.

#### 4.2.10 Electromagnetic Interference/Electromagnetic Compatibility Analysis

ULA maintains an Electromagnetic Interference (EMI)/Electromagnetic Compatibility (EMC) Control Plan to ensure compatibility between all avionics equipment. This plan covers requirements for bonding, lightning protection, wire routing and shielding, and procedures. ULA analyzes intentional and unintentional RF sources to confirm 6-decibel (dB) margins with respect to all general EMI/EMC requirements. In addition, Electro-explosive Device (EED) RF susceptibility analyses are performed to range requirements for both the LV and SC. The SC analysis is performed by the SC manufacturer and reviewed by ULA. The presence of an RF environment will affect safety margins of EEDs. This analysis confirms a minimum 20-dB margin with respect to the direct current (dc) EED no-fire power level. The purpose of the EED susceptibility analysis is to demonstrate that safety margins of each EED are maintained when exposed to the flight vehicle and site sources RF environment. ULA publishes comprehensive reports describing requirements and results of these analyses.

#### 4.2.11 Contamination Analysis

Section 3.1.3 discusses control of contamination (to meet analysis assumptions) during ground operations and Section 3.2.7 discusses control of contamination for flight operations.

ULA provides SC with an assessment of contamination contributions from Atlas V LV sources, as required. ULA identifies and analyzes contamination sources starting from PLF encapsulation of the SC through CCAM, This provides a qualitative assessment of the factors affecting SC contamination to allow the SC customer to approximate final on-orbit contamination budgets. A more detailed mission-unique analysis can be provided to the SC customer if mission-unique deposition requirements are specified in the ICD.

#### 4.2.12 RF Link Compatibility and Telemetry Coverage Analysis (Airborne)

ULA conducts an airborne link analysis on all RF links between ground stations and the Atlas/Centaur vehicle to determine whether the signal strength between the RF system on the LV and the RF system at the receiving station meets mission requirements. ULA analyzes the S-band telemetry system, the active C-band vehicle tracking system, and the flight termination system (FTS). ULA considers airborne and ground station equipment characteristics, vehicle position, and attitude. This analysis determines if adequate link margins can be obtained with the receiving ground stations and the Tracking and Data Relay Satellite System (TDRSS), when used. ULA publishes a comprehensive report describing link requirements and results.

ULA conducts an RF compatibility analysis between all active airborne RF transmitters and receivers to ensure proper function of the integrated system. Transmit frequencies and their harmonics are analyzed for potential interference to each active receiver. If interference exists, a worst-case power-level analysis takes place to determine what effect the interference frequency has on the receiver's performance. In addition, strong site sources, such as C-band site radar, are also analyzed. The SC contractor provides details of active transmitters and receivers for this analysis. ULA publishes a comprehensive report describing analysis requirements and results.



#### 4.2.13 RF Link Compatibility and Telemetry Coverage Analysis (Ground)

For customers who require communication with their SC during prelaunch activities, ULA conducts a ground link analysis on SC RF systems to ensure that a positive link exists between the SC and the SC checkout equipment to analyze the SC telemetry and command system. The RF reradiate system provides sufficient margin to minimize effects of deviations or fluctuations in RF power and provides consistent system performance to ensure positive link margin during the required time periods. Information about SC requirements is in the ICD. ULA publishes a technical report describing link requirements and implementation of the link system.

#### 4.2.14 Performance Analysis

ULA evaluates the capability of Atlas V to place the SC into the required orbit using trajectory simulation tools. Vehicle performance capability is provided through our Configuration, Performance, and Weight Status Report (CPWSR). This report is tailored to accommodate needs of specific missions.

The status report shows the current LV propellant margin and Flight Performance Reserve (FPR) for the given mission and SC mass. It includes a comprehensive list of the vehicle configuration status, mission-unique ground rules and inputs, and vehicle masses for performance analysis. The report also provides the more commonly used SC partial derivatives (tradeoff coefficients) with respect to the major vehicle variables (e.g., stage inert weights, propellant loads, stage propulsion parameters). The detailed trajectory simulation used for the performance assessment appears as an appendix to the report.

#### 4.2.15 Stability and Control Analysis

ULA performs a linear stability analysis, primarily frequency response and root-locus techniques, and a nonlinear time-varying 6-DOF simulation to determine Atlas V and Centaur autopilot configurations; establish gain and filter requirements for satisfactory rigid body, slosh, and elastic mode stability margins; verify vehicle and launch stand clearances; and demonstrate Centaur RCS maneuver and attitude hold capabilities. Uncertainties affecting control system stability and performance are evaluated through a rigorous stability dispersion analysis. Tolerances are applied to vehicle and environmental parameters and analyzed using frequency response and nonlinear simulation methods, ensuring that the Atlas V autopilot maintains robust stability throughout the defined mission. Correlation of simulation results with previous post-flight data has confirmed the accuracy of these techniques.

#### 4.2.16 Mass Properties Analysis

ULA performs mass properties analysis, reporting, and verification to support performance evaluation, structural loads analysis, SC/LV separation analysis, ground operations planning, airborne shipping requirements, and customer reporting requirements.

#### 4.2.17 Trajectory Analysis and Design

The ULA trajectory design process ensures that all SC, LV, and range-imposed environmental and operational constraints are met during flight, while simultaneously providing performance-efficient flight designs. This process typically provides Propellant Margin (PM) above required performance reserves.

The trajectory design and simulation process provides the vehicle performance capability for the mission. It provides the basis, through simulation of dispersed vehicle and environmental parameters, for analyses of FPR and injection accuracy. Telemetry coverage assessment, RF link margins, PLF venting, and in-flight thermal analyses also rely on the reference mission design. The status report (Section 4.2.14) documents the trajectory design and the tradeoffs used.

ULA trajectory analysis tools incorporate detailed propulsion, mass properties, aerodynamic, and steering control modeling, as well as oblate Earth and gravity capability, selectable atmospheric models, and other

selectable routines, such as Sun position and tracker locations, to obtain output for these areas when they are of interest.

These simulation tools interface directly with actual flight computer software. This feature bypasses the need to have engineering equivalents of flight software. Another powerful feature is compatibility with 6-DOF modeling of the vehicle, which facilitates key dynamic analyses for our Atlas V vehicle family. Other features include significant flexibility in variables used for optimization, output, and simulation interrupts.

#### **4.2.18 Guidance Analysis**

ULA performs analyses to demonstrate that SC guidance and navigation requirements are satisfied. Analyses include targeting, standard vehicle dispersions, extreme vehicle dispersions, and guidance accuracy. The targeting analysis verifies that the guidance program achieves all mission requirements across launch windows throughout the launch opportunity. Standard vehicle dispersion analysis demonstrates that guidance algorithms are insensitive to 3-sigma vehicle dispersions by showing that the guidance program compensates for these dispersions while minimizing orbit insertion errors. Extreme vehicle dispersions (e.g., 10 sigma) and failure modes are selected to stress the guidance program and demonstrate that the guidance software capabilities far exceed the vehicle capabilities.

#### **4.2.19 Injection Accuracy Analysis**

The guidance accuracy analyses that combine vehicle dispersions and guidance hardware and software error models to evaluate total guidance system injection accuracy. Hardware errors model off-nominal effects of guidance system gyros and accelerometers. Software errors include Fault Tolerant Inertial Navigation Unit (FTINU) computation errors and vehicle dispersion effects. Positive and negative dispersions of more than 30 independent vehicle and atmospheric parameters that perturb Atlas V and Centaur performance are simulated. The accuracy analysis includes sensor noise, effects of vehicle prelaunch twist and sway on guidance system alignment during gyro compassing, and the covariance error analysis of the guidance hardware.

#### **4.2.20 Launch Window Analysis**

ULA performs launch window analyses to define the open and close dates and times of mission-specific launch windows that satisfy mission-specific requirements on each launch day within the launch period. The Atlas/Centaur LV can accommodate launch windows at any time of day and any day of the year within performance capability constraints for a given mission design. ULA requests that customers provide opening and closing times for the maximum launch window the SC is capable of supporting. If the launch windows are several hours long or multiple windows in a single day, then ULA and the customer will jointly choose a span within the total launch opportunity. This decision can be made as late as a few days before launch. The selected span is chosen based on operational considerations, such as preferred time of day or predicted weather.

Some missions may have more complicated window constraints requiring analysis by ULA. For example, launch system performance capability constrains windows for missions that require precise control of the right ascension of the ascending node. That control is achieved by varying the trajectory as a function of launch time. Other constraints may include solar illumination considerations. We have successfully analyzed a variety of window constraints for past missions, and ULA is prepared to accommodate required window constraints for future missions.

Any launch window duration can be accommodated. However, a window of 30 minutes or more is recommended. Shorter windows increase the risk of a launch delay if exceeded due to weather or technical problem resolution. Windows longer than 3 hours for Atlas V may be limited by liquid commodity supplies or crew rest. Windows greater than 2 hours may require the conservation of commodities during the window, and thus may not represent continuous launch opportunities.

#### 4.2.21 Wind Placard Analysis (Prelaunch, Flight)

Wind tunnel tests of the Atlas V configurations have been performed to determine loading for ground and flight wind conditions. This information, combined with launch site wind statistics, is used to determine the wind placards and subsequent launch availability for any given launch date. Atlas V vehicle configurations provide at least 85% annual launch availability.

#### 4.2.22 Flight Safety Analyses and Data

ULA conducts and submits flight safety analyses as required to comply with Eastern/Western Range regulations to obtain both Preliminary Flight Plan Approval (PFPA) and Final Flight Plan Approval (FFPA). For new Atlas V missions that are Single Flight Azimuth (SFA) and similar in configuration and flight azimuth to previously flown Atlas V missions, submittals typically occur approximately 1 year before launch for the Preliminary Flight Data Package (PFDP) and approximately 60 days before launch for the Final Flight Data Package (FFDP). For new Atlas V missions that are Variable Flight Azimuth (VFA) and/or not similar in configuration or flight azimuth to previously flown Atlas V missions, the PFDP may need to be submitted up to 2 years prior to launch and the FFDP up to 6 months prior to launch. Required PFDP and FFDP documentation and digital media are provided to the applicable Range Safety agency in specified formats and include vehicle and mission descriptions, nominal and dispersed trajectories, impact locations of jettisoned hardware, and an overflight risk analysis.

#### 4.2.23 End-to-End Electrical Compatibility Analysis

ULA conducts an independent, end-to-end electrical circuit interface compatibility analysis (ICA) to verify proper voltage and current parameters and any required timing and sequencing interfaces between all SC and LV airborne interfaces (through to the end function). The ICA verifies ICD/EICD requirements against SC and LV released engineering to ensure electrical compatibility between the interfaces prior to the fabrication of flight hardware. Verification of electrical compatibility between the LV and the SC interfaces is reviewed to the first active circuit on the LV and the SC side of the interface, mission critical ground and airborne circuits.

This analysis requires SC data from released electrical schematics and build/installation engineering, such as contact assignments, wiring interfaces, and circuit detail of avionics (first level) to verify end-to-end (SC-to-LV) compatibility. All "in-between" wiring and circuits are analyzed to verify proper routing, connections, and functionality of the entire system interface. This analysis is documented as part of the ICD verification process and used to generate inputs for all necessary launch site interface testing.

#### 4.2.24 Postflight Data Analysis

For Atlas V missions, ULA uses proven analysis techniques to obtain the individual stage and SC performance information derived from available LV telemetry data. Main outputs of the analysis are: (1) Atlas V stage performance with respect to the predicted nominal (given in terms of Centaur propellant excess), (2) Centaur stage performance with respect to its predicted nominal (given also in terms of Centaur propellant excess), and (3) the average thrust and specific impulse of the Centaur stage. In addition to these outputs, the post-flight performance report presents historical data for past flights of similar family and statistics of the parameters of interest. The report provides a trajectory listing of simulated Centaur flight that effectively matches observed data from the actual flight.

A primary input into the post-flight vehicle performance analysis is flight telemetry data. Telemetered outputs from the Propellant Utilization (PU) system are used to obtain propellants remaining in the liquid oxygen (LO<sub>2</sub>) and liquid hydrogen (LH<sub>2</sub>) tanks at Centaur final cutoff. Times of key vehicle mark events are also required. The actual vector states of radius and velocity at Atlas V stage shutdown, compared to the predicted nominal values, provide sufficient knowledge to obtain the Atlas V stage performance. The flight propellant excess at Centaur final cutoff (from the PU system data) and the actual burn times for Centaur provide key data to determine the thrust and specific impulse for the Centaur stage.

In addition to the performance evaluation of the LV, the post-flight report provides an assessment of injection conditions in terms of orbital parameters and deviations from target values and SC separation attitude and rates. The report also documents SC environments to the extent that the LV instrumentation permits. These environments could include interface loads, acoustics, vibration, and shock.

Finally, the report presents analyses of individual LV system performance and documents any anomalies noted during the mission. LV and landline telemetry data provide the primary source of information for these analyses. Additionally, results of the review of optical data (from both fixed cameras at the launch site and tracking cameras) and radar data are also presented in the report.

#### **4.2.25 Destruct System Analysis**

ULA provides LV destruct system analysis in Range Safety System Reports (RSSR). Atlas V vehicle configurations are addressed in RSSR 14000-00-021. The reports comply with requirements specified in Appendix 4A of EWR 127-1, October 1997.

RSSR documents provide an overview of each vehicle configuration and detailed descriptions of the Flight Termination System (FTS), C-band tracking system, S-band telemetry system, and ground support equipment for Eastern and Western Range Safety systems. Component and system-level testing is also described. Antenna patterns, link margins, and FTS battery load capacity analyses are included.

As indicated in Section 4.3, the Atlas V program develops a SC FTS configuration concurrence request for each mission (dedicated SC destruct capabilities are generally not required for communications SC).

#### **4.2.26 Mission Targeting**

ULA conducts mission targeting to define target orbit parameters that will be used to guide the LV into the desired orbit. This process requires a target specification from the SC agency and results in publication of flight parameter loads used for the flight computer and mission-unique software configuration drawing documentation.

#### **4.2.27 Mission-Unique Flight Software**

The mission-unique software activity for mission integration is a controlled process that ensures the generation and release of validated Flight Control Subsystem (FCS) software to support the launch schedule. The modular software design minimizes the impact of changes due to mission-unique requirements. This is achieved through the generic software design philosophy, which has been applied during development and evolution of the Atlas V FCS architecture. A parameterized software design has been implemented so that baseline FCS software is able to support the functionality necessary to fly most Atlas V missions. Parameters are then set to properly implement the required mission-unique functionality.

ULA schedules periodic updates to FCS software baselines to support updates in the vehicle hardware configuration or to implement capability enhancements as required by the Atlas V program.

A rigorous software validation test program is executed using the specific mission trajectory and targeting parameters to validate the flight software and parameter data load under nominal, 3-sigma dispersed, severe stress, and failure mode environments, before release for flight. Testing and validation take place in the Systems Integration Laboratory (SIL), which includes flight-like avionics components operating within a real-time simulation environment.

## 4.3 RANGE AND SYSTEM SAFETY INTERFACES

### 4.3.1 Requirements and Applicability

To launch from either Cape Canaveral Air Force Station (CCAFS), FL, or Vandenberg Air Force Base (VAFB), CA, LV/SC design and ground operations must comply with applicable launch site Range Safety regulations, USAF requirements concerning explosives safety, and U.S. consensus safety standards. In addition, compliance with applicable facility safety policies is also required when using SC processing facilities operated by Spaceport Systems International (SSI), Astrotech Space Operations Inc. (ASO), NASA, or the USAF.

CCAFS and VAFB Range Safety organizations have regularly updated their safety requirements documents. Effective 1 July 2004, the single safety document for both CCAFS and VAFB (Eastern/Western Range Regulation [EWR] 127-1) was replaced by AFSPCMAN 91-710. Existing LV and SC programs may not be affected by the new AFSPCMAN 91-710 regulations unless required by the SC contracting agency. New programs introduced after 1 July 2004 will negotiate applicable regulations with the Range Safety Office (45<sup>th</sup> Space Wing for Eastern Range and 30<sup>th</sup> Space Wing for the Western Range). Earlier versions of Range regulations may still apply to a given SC or mission, depending on when the SC bus was originally designed and constructed and approved by the Eastern and/or Western Range Safety organizations.

Applicable safety compliance documents are determined during negotiations with Range Safety, ULA, and the SC at the outset of the mission integration process.

Other safety documents that may also apply to the launch site safety interface are:

1. Radiation Protection Program, 45 Space Wing Instruction 40-201
2. Air Force Manual (AFM) 91-201, Explosives Safety Standard
3. Air Force Regulation (AFR) 127-12, Air Force Occupational Safety, Fire Prevention, and Health Program
4. MIL-STD 1522A, Standard General Requirements for Safe Design and Operation of Pressurized Missile and Space Systems
5. MIL-STD 1576, Electro-explosive Subsystem Safety Requirements and Test Methods for Space Systems
6. NASA KHB 1710.2, KSC Safety Practices Handbook (for SC processed at Kennedy Space Center facilities)
7. Atlas Launch Site Safety Manual / Launch Complex Safety Plan
8. Payload Processing Facility (PPF) Safety Manual (ex., Astrotech Space Operations, Facility Safety Manual (SHI-ASO-M008 or SHI-ASO-M0011))

At the start of the safety integration process (Section 4.3.2), Range Safety documents applicable to SC design and ground processing operations will be determined. Safety requirements applicable to new designs and ground processing operations will be reviewed and tailored for specific SC and mission applications.

ULA System Safety engineers will evaluate mission-specific SC designs and ground processing operations and provide guidance for successful completion of the Range review and approval process. Should areas of noncompliance be identified, ULA will evaluate each area and as appropriate, provide guidance for resolution of specific noncompliance items while still meeting the intent of the applicable safety requirements. For commercial programs, ULA as required, will act as the SC contractor's liaison and facilitate interface activities with the launch site Range Safety Office.

Range Safety requirements require three inhibits (dual-fault tolerance) if system failures could result in catastrophic events and two inhibits (single-fault tolerance) if failures could result in critical events. Critical and catastrophic events are defined in EWR 127-1 or AFSPCMAN 91-710 as applicable. The Range typically applies the three-inhibit requirement to safety-critical electrical systems, including the SC's Category A ordnance circuits, during ground processing operations at the launch site (e.g., encapsulation of SC at the processing facility, transport of encapsulated SC to SLC-41/SLC-3E, mate of encapsulated assembly to the LV). During final ground processing of Atlas V payloads, the integrated SC and LV stack (in launch configuration) is transported from the VIF to the LC-41 pad. When Category A SC circuits use the Atlas V LV's ordnance controller during transport to the SLC-41/SLC-3E pad, the three-inhibit requirement is satisfied. If the SC's Category A ordnance circuits are independent from the LV, SC customers should review their bus designs and ground operations plans and notify the Atlas V program if SC systems do not provide the required fault tolerance. As stated above, ULA will then assess mission-specific designs, evaluate hazard controls, and work with Range Safety to develop and implement "meets-intent" resolutions.

For each SC and mission, compliance with applicable Range Safety regulations (as tailored) will be addressed in the mission specific safety submittals defined in Section 4.3.2.

#### 4.3.2 Safety Integration Process

Figure 4.3.2-1 shows the ULA process to facilitate Range and system safety coordination and receive Range Safety approval and/or permission to launch. This figure identifies responsibilities of the SC and/or Launch Services Integration Contractor (LSIC), and/or NASA, and/or other government contracting agency, ULA, and the Range. Timelines identified in this process are typical and may vary to accommodate mission specific requirements.

For each mission integration effort, ULA provides qualified engineers to assist the SC contractor during the Range review and approval process. For commercial missions ULA obtains all Range Safety and system safety approvals. The following paragraphs summarize the safety integration process and define safety data to be developed by the SC customer during implementation of this process. Section 4.5.3.6 provides additional information on SC data requirements.

**Mission Orientation** — Soon after contract award, ULA and the SC introduce a new system or mission to Range Safety during a mission orientation meeting at the Range Safety Office or a similar venue. Figure 4.3.2-1, Block A, shows basic elements of this orientation. The orientation provides a general overview of the mission and provides a forum for coordination of mission-unique requirements, schedules, and data submittals. Mission-unique designs and operational issues are reviewed so agreements can be established during the early phase of mission integration. Range Safety requirements that will be imposed on SC designs and ground processing operations are identified.

For follow-on missions, a formal meeting is generally not necessary. In those cases, ULA will develop and submit a mission orientation letter to coordinate mission-unique requirements, schedules, and data submittals. The SC contractor will be required to provide inputs to the mission orientation letter.

**Spacecraft and Launch Vehicle Safety Assessments** — Mission-unique SC designs and ground processing operations are documented in the Missile System Prelaunch Safety Package (MSPSP) or Safety Assessment Report (SAR), (Figure 4.3.2-1, Block B). The SC develops the SC MSPSP/SAR to describe the SC, document potential hazards associated with ground processing operations at the Range (e.g., pressure systems, propellant systems, propulsion system, ordnance control systems, toxic and hazardous materials, SC access requirements, RF testing, ionizing and non-ionizing sources hazard controls, battery charging at the pad, etc., and affiliated ground support equipment and operations), and define the means by which each hazard is controlled to an acceptable level of risk. Range Safety regulations provide details on the format and contents of the MSPSP/SAR.

The initial or Phase 1 SC MSPSP/SAR is typically submitted to the Range and ULA approximately 12 to 10 months before Initial Launch Capability (ILC). The final or Phase II SC MSPSP/SAR is typically submitted to ULA about 5 months before scheduled ILC. The Phase III SC MSPSP/SAR typically incorporates verification

close-out data and the tracking log and is typically submitted approximately 1 month prior to hardware arrival at the PPF.

For commercial missions, ULA will forward the MSPSP/SAR to Range Safety, review it, and provide comments if necessary. ULA also forwards the ULA comments to the Range and SC for additional formal review and disposition. For other missions, the SC/LSIC may submit the MSPSP/SAR directly to Range Safety; however, ULA also reviews the MSPSP/SAR in parallel with Range Safety.

ULA combines data from the SC MSPSP/SAR with data from existing baseline Atlas V LV safety reports (Figure 4.3.2-1, Block C) and the mission-specific ICD to perform and document a safety assessment of the LV-to-SC interface. Results of this assessment will be delivered to the Range as the Mission-Unique LV MSPSP (Figure 4.3.2-1, Block D).

For Western Range programs, ULA develops and submits seismic assessment for ULA hardware, operations, and integrated ULA-to-SC stack configurations. Some SCs may also be required to perform a similar assessment.

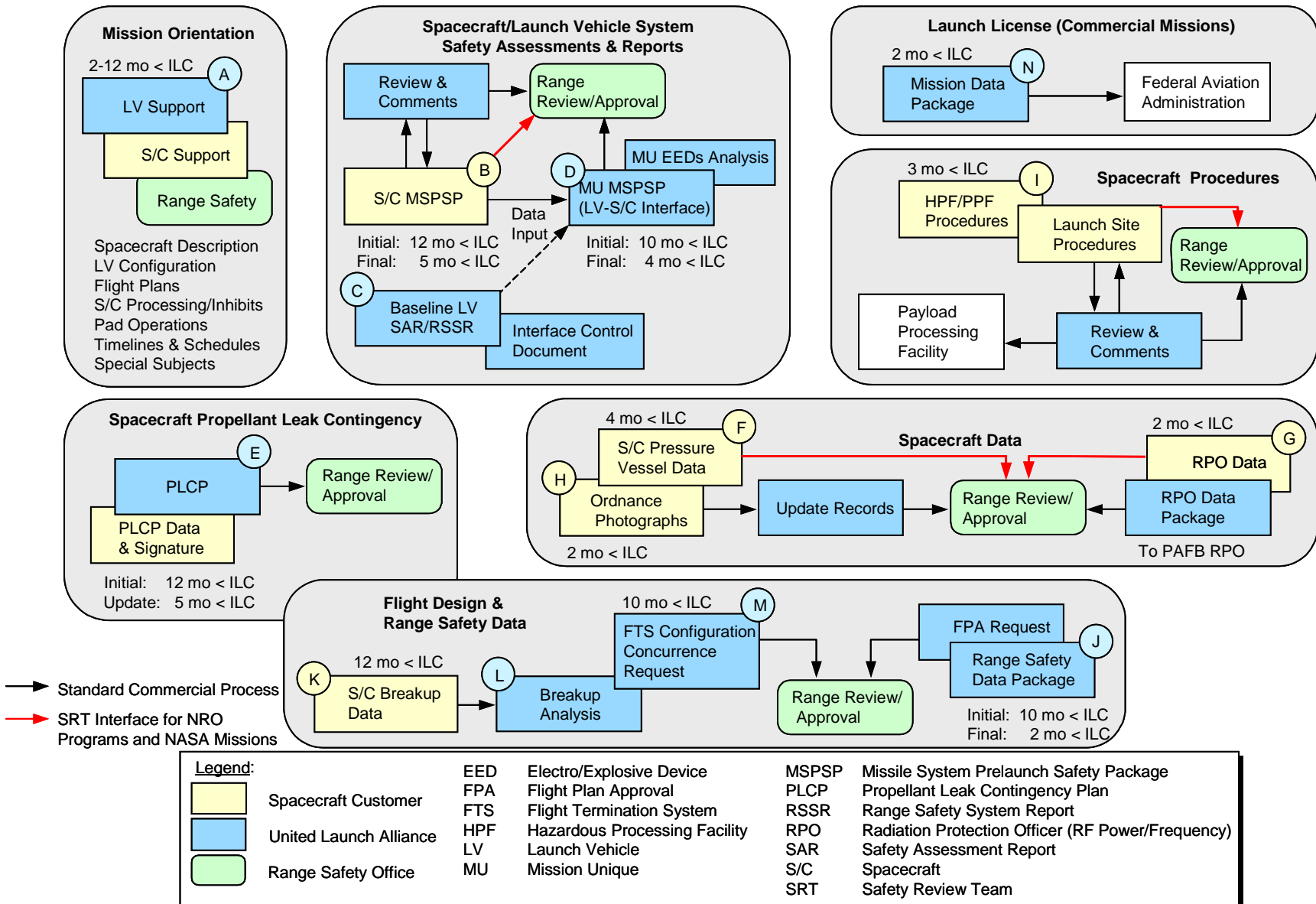
**Spacecraft Propellant Leak Contingency Plan (PLCP)** — Based on data supplied by the SC contractor (e.g., hardware locations, access requirements, ground support equipment), ULA develops the SC PLCP (Figure 4.3.2-1, Block E). The PLCP provides a top-level plan for depressurization and/or offload of SC propellants should leakage occur. The provisions of this plan become applicable once the SC is encapsulated at the PPF, during transport, and once it has been mated to the Atlas LV at the launch complex, and remains in effect until completion of final PLF closeout activities. Selected elements of this plan may also be implemented if an incident occurs after completion of closeout efforts. The SC is required to develop detailed procedures to implement offload operations.

**Spacecraft Data** — The SC will provide pressure vessel qualification and acceptance test data to the Range for review and acceptance. These data appear in Figure 4.3.2-1, Block F. For follow-on missions, if the previously submitted pressure vessel qualification data remains unchanged, only acceptance data are required. ULA is provided a copy for review.

The SC contractor should also submit data specifying the type and intensity of RF radiation that the SC may transmit during ground testing, processing, and launch at the Range. The data should be included in the SC MSPSP/SAR. For Eastern Range launches, ULA forwards these data to the Radiation Protection Officer (RPO) for review and approval of RF related operations required at the launch site. At the Western Range, SC contractors communicate these data directly with the Range. The process appears in Figure 4.3.2-1, Block G. Section 4.5.3.6.3 summarizes of data required by the Range RPO. Detailed descriptions of data required can be found in the MSPSP content requirements of Range Safety Requirements (EWR 127-1 or AFSPCMAN 91-710). The SC contractor may be required to complete the appropriate RPO forms such as AFSC Form 2246 and 2257.

The Range requires photographs showing locations of ordnance items installed on the SC. These data appear in Figure 4.3.2-1, Block H. SC ordnance photographs may be submitted to the Range through ULA, or the SC may submit ordnance photographs directly to the Range Safety Office, this data must be provided to Range Safety prior to SC transport to the launch site from the PPF. If the SC selects the direct submittal option, ULA requires notification that photographs have been delivered. A follow-up meeting between the Range and the SC contractor is typically required to review ordnance data.

Figure 4.3.2-1: Atlas V Safety Integration Process\*



\*Timelines Typical Mission Specific Adjustments as Required



**Spacecraft Procedures** — The SC submits onsite processing procedures, PPF procedures, and launch pad procedures (SLC-41/VIF and/or SLC-3E) (Figure 4.3.2-1, Block I) to the operator of the PPF (e.g., Astrotech SSI, NASA, or Air Force) and the Range for review and approval. Procedures to be implemented at either launch pad must comply with applicable Range Safety regulations and ULA policies. Procedures and operations that involve ULA personnel (ex., SC mate, encapsulation, etc.), or that are performed at the launch site, require ULA review. As indicated in Section 4.3.1, PPF procedures must also comply with the applicable processing facility's safety policy. For first time missions, the Range requires submittal of all SC procedures (hazardous and non-hazardous). For follow-on missions, only hazardous procedures may be required for submittal. For commercial missions, ULA forwards the SC procedures to Range Safety and the PPF operator if requested.

**SC RF** — Inadvertent SC RF Transmitter/Emitter "ON" is not acceptable and is considered a potentially catastrophic hazard. Inadvertent/unplanned SC RF transmissions could encroach upon required EWR 127-1 EMI Safety Margins (EMISMs) (20 dB for Ordnance and 6 dB for Avionics). Inadvertent SC transmissions may also interfere with Atlas FTS and/or other avionics operations. If inadvertent SC RF transmission is controlled by three independent inhibits, then the hazard is considered adequately controlled. If the SC has less than three independent inhibits, ULA may be able to perform an "RF Bounce Analysis" that shows no EMISM margin encroachment; however, if that analysis shows encroachment, then the SC may be required to change the SC design or may be required to submit a Requirements Relief Request (i.e., a waiver) to Range Safety and ULA.

1. SC power-off during LV ordnance activity

During LV ordnance connections at the launch site, the SC must be powered OFF (i.e., not just RF silence and no power switching). The schedule for SC power off times and duration will be coordinated with the SC at the GOWG and daily schedule meetings at the SC PPF. However, if SC power OFF is not possible, then ULA will analyze the SC power-on configuration (i.e., Battery trickle charge, thermal conditioning heaters, TLM, memory keep-alive, etc.) to determine if there is interference with LV ordnance operations. If that analysis shows interference, then the SC may be required to change the SC design or operations, or may be required to submit a Requirements Relief Request (i.e., a waiver) to Range Safety and ULA.

**Flight Design and Range Safety Data** — The ULA Trajectory and Performance group develops Preliminary and Final Flight Data Packages (see Figure 4.3.2-1 Block J) for submittal to Range Safety. These Flight Data Packages enable the responsible Range Safety agency to evaluate whether the proposed mission is acceptable from the safety perspective via the issuance of a Flight Plan Approval (FPA). Also, the Flight Data Packages provide the data required by the responsible Range Safety agency to augment their launch operations support requirements. Section 4.2.22 contains more information about the Flight Data Package. Following the submittal of each mission flight Data Package is a formal written request for Preliminary or Final Flight Plan Approval. The Flight Data Packages describe the basic SC configuration, the preliminary flight profile and the time of launch. ULA submits the preliminary package to the Range approximately 12 months before ILC. The Preliminary Flight Data Package includes a Preliminary Flight Plan Approval (PFFPA) request to fly the mission on the Range. Approximately 2 months before ILC, ULA will submit the Final Flight Data Package (FFDP) with a request for final FPA. Final FPA is usually received from the Range approximately 7 days before ILC.

Documented separately but still considered a required component of the Flight Data Package is the SC Intact Impact Analysis (see Section 4.5.3.6.4.2 for more information). This analysis provides SC debris characteristics resulting from both intact impact and vehicle destruct/re-entry scenarios. The SC customer is required to provide SC breakup data to ULA to support this analysis.

To support development of the Range Safety data package, the SC contractor provides SC propellant quantities, propulsion system inhibit details, Isp, and breakup data (Figure 4.3.2-1, Block K) to ULA. ULA uses the breakup data to perform an integrated LV and SC debris and risk analysis (Figure 4.3.2-1, Block L). Section 4.5.3.6.4 contains additional information on SC breakup data and analysis.

Based on results of the breakup analysis and the SC propulsion system characteristics, ULA will submit an FTS concurrence request to the Range (Figure 4.3.2-1, Block M). The purpose of this concurrence request is to obtain an agreement with the Range regarding requirements for a designated SC destruct capability. Because there are no appreciable and/or additional public safety hazards with typical missions, ULA typically pursues FTS concurrence without a separate SC destruct system.

**Launch License (Commercial Missions)** — For commercial missions, CLS maintains a launch license from the Federal Aviation Administration (FAA). The Atlas launch license requires a mission supplement to address each commercial mission. ULA develops a mission-specific addendum to the baseline license for each commercial flight and submit this data package (Block N, Figure 4.3.2-1) to the FAA. SC information included in the FAA data package will include MSPSP approval status and overviews of hazardous SC commodities (propellants, pressure systems, batteries, etc).

## 4.4 POLICIES

This section provides potential and current launch services customers with information concerning some management, integration, and production policies to ensure efficient integration and launch of the customer's SC.

### 4.4.1 Launch Vehicle Logos

As part of our standard launch service, the Atlas V program offers customers the option of placing a mission or company logo on portions of that mission's PLF hardware. The logo can be placed in standard locations on the PLF cylindrical section (See Section 6.1.5 or 6.2.6). To support manufacture of the mission PLF, the Atlas V program typically needs to have final artwork for the logo no later than 6 months before launch for 400 series missions and 11 months before launch for 500 series missions. This timeframe allows the ULA engineering organization to transform the artwork into a template to be used for application of the final logo artwork onto the fairing. Delivery of the customer PLF logo design is a schedule milestone required to support nominal assembly spans for PLF fabrication. Changes to the logo shall be supplied at a time that supports scheduled PLF completion date.

### 4.4.2 Launch Scheduling Guidelines

The latest ULA Launch Manifest Guidelines can be found on the ULA Launch Manifest website at [www.ulalaunch.com](http://www.ulalaunch.com), or contact ULA for further information.

### 4.4.3 Spacecraft Launch Window Options

Atlas V can be launched at any time of the day and any day of the year. However, seasonal weather patterns should be considered in setting launch windows when possible. Launches in the afternoon from CCAFS during June, July, August, and September may have an increased probability of delays due to seasonal thunderstorm activity. Scheduling in the morning reduces the risk of such delays and avoids cost associated with them. Options for afternoon summer launches may be available with recognition of the additional schedule delay potential.

### 4.5 SPACECRAFT DATA REQUIREMENTS AND CUSTOMER RESPONSIBILITIES

The items listed in this section are representative of the information required for SC integration and launch activities. Additional information may be required for specific SC.

#### 4.5.1 Interface Control Document Inputs

Table 4.5.1-1 indicates the SC information required to assess compatibility with the Atlas LV. Data usually are provided by the customer in the form of an IRD and are the basis for preparing the ICD. Shaded items should be provided for a preliminary compatibility assessment, while all items should be completed for a detailed assessment. The shaded items are typically supplied by the SC before a proposal is offered for Atlas V Launch Services. These lists are generalized and apply to any candidate mission. If ULA has experience with the SC bus or SC contractor, less information can be provided initially (assuming the SC contractor is willing to use a "same as mission \_\_\_\_\_" designation for purposes of assessing preliminary compatibility). A complete IRD is typically supplied within 30 days of contract signing.

Tables 4.5.1-2 through 4.5.1-7 indicate SC data required after contract signature to start integration of the SC. The asterisks in these tables indicate data desired at an initial meeting between ULA and the customer. These data will provide the detailed information required to fully integrate the SC, determine such items as optimum mission trajectory, and verify compatibility of LV environments and interfaces.

**Table 4.5.1-1: Spacecraft Information Worksheet (1 of 6)**

For a preliminary compatibility assessment, all shaded items should be completed. For a detailed compatibility assessment, all items should be completed.		
<b>Spacecraft Name:</b>	<b>Spacecraft Manufacturer:</b>	
<b>Spacecraft Owner:</b>	<b>Spacecraft Model No.:</b>	
<b>Name of Principal Contact:</b>	<b>Number of Launches:</b>	
<b>Telephone Number:</b>	<b>Date of Launches:</b>	
<b>Date:</b>		
<b>Spacecraft Design Parameter</b>	<b>SI Units</b>	<b>English Units</b>
TRAJECTORY REQUIREMENTS		
Spacecraft Mass	_____ kg	_____ lbm
Operational Spacecraft Lifetime	_____ yr	_____ yr
Final Orbit Apogee	_____ km	_____ nmi
Final Orbit Perigee	_____ km	_____ nmi
Final Orbit Inclination	_____ deg	_____ deg
Propulsion — Propellant Type, Orbit Insertion		
Propulsion — Propellant Type, Stationkeeping		
Propulsion — Propellant Mass	_____ kg	_____ lbm
Propulsion-Effective I <sub>sp</sub>	_____ s	_____ s
Maximum Apogee Allowable	_____ km	_____ nmi
Minimum Perigee Allowable	_____ km	_____ nmi
Argument of Perigee Requirement	_____ deg	_____ deg
Right Ascension of Ascending Node Requirement	_____ deg	_____ deg
Apogee Accuracy Requirement	_____ ±km	_____ ± nmi
Perigee Accuracy Requirement	_____ ±km	_____ ±nmi
Inclination Accuracy Requirement	_____ ±deg	_____ ±deg
Argument of Perigee Accuracy Requirement	_____ ±deg	_____ ±deg
Right Ascension of Ascending Node Accuracy Requirement	_____ ±deg	_____ ±deg

Table 4.5.1-1: Spacecraft Information Worksheet (2 of 6)

Spacecraft Design Parameter	SI Units	English Units
<b>MECHANICAL INTERFACE</b>		
Spacecraft Mechanical Drawing (Launch Configuration)		
Spacecraft Effective Diameter	_____ mm	_____ in.
Spacecraft Height	_____ mm	_____ in.
Spacecraft/Launch Vehicle Interface Diameter	_____ mm	_____ in.
Payload Sep System Supplier (Spacecraft or Launch Veh)		
Payload Adapter Supplier (Spacecraft or Launch Vehicle)		
Maximum Spacecraft Cross-Sectional Area	_____ m <sup>2</sup>	_____ ft <sup>2</sup>
Spacecraft Access Points		
SC Purge Requirements (Air/GN2, etc.)		
Pre-Separation RF Transmission Requirement	_____ band	_____ band
<b>ELECTRICAL INTERFACE</b>		
Spacecraft Electrical Drawing (Near LV Interface)		
Number of Launch Vehicle Signals Required		
Number of Separation Discretes Required		
Number of Umbilicals & Pins/Umbilical		
Curve of Spacecraft-Induced Elec. Field Radiated Emissions	_____ dB $\mu$ V/m	N/A
Curve of Spacecraft-Radiated Susceptibility	_____ dB $\mu$ V/m	N/A
Number of Instrumentation Analogs Required		
<b>THERMAL ENVIRONMENT</b>		
Prelaunch Internal PLF Ground Transport Temperature Range	_____ °C	_____ °F
Prelaunch Internal PLF Launch Pad Temperature Range	_____ °C	_____ °F
Maximum Prelaunch Gas Impingement Velocity	_____ m/s	_____ ft/s
Maximum Ascent Heat Flux	_____ W/m <sup>2</sup>	_____ Btu/hr-ft <sup>2</sup>
Maximum Free-Molecular Heat Flux	_____ W/m <sup>2</sup>	_____ Btu/hr-ft <sup>2</sup>
Maximum Fairing Ascent Depressurization Rate	_____ mbar/s	_____ psi/s
Spacecraft Vented Volume(s)	_____ m <sup>3</sup>	_____ ft <sup>3</sup>
Spacecraft Vent Area(s)	_____ cm <sup>2</sup>	_____ in <sup>2</sup>
Prelaunch Relative Humidity Range	_____ %	_____ %
Pre-separation Spacecraft Power Dissipation	_____ W	_____ Btu/hr
Maximum Free-Stream Dynamic Pressure	_____ mbar	_____ psi
<b>DYNAMIC ENVIRONMENT</b>		
Maximum Allowable Flight Acoustics	_____ dB OA	_____ dB OA
Allowable Acoustics Curve		
Maximum Allowable Sine Vibration	_____ G <sub>RMS</sub>	_____ G <sub>RMS</sub>
Allowable Sine Vibration Curve	_____ G <sub>RMS</sub>	_____ G <sub>RMS</sub>
Maximum Allowable Shock	_____ g	_____ g
Allowable Shock Curve		

Table 4.5.1-1: Spacecraft Information Worksheet (3 of 6)

Spacecraft Design Parameter	SI Units	English Units
DYNAMIC ENVIRONMENT CONTINUED		
Maximum Acceleration (Static + Dynamic) Lateral	_____ g	_____ g
Maximum Acceleration (Static + Dynamic) Longitudinal	_____ g	_____ g
Fundamental Natural Frequency — Lateral	_____ Hz	_____ Hz
Fundamental Natural Frequency — Longitudinal	_____ Hz	_____ Hz
Cg—Thrust Axis (Origin at Separation Plane)	_____ mm	_____ in.
Cg — Y Axis	_____ mm	_____ in.
Cg — Z Axis	_____ mm	_____ in.
Cg Tolerance — Thrust Axis	_____ ±mm	_____ ±in.
Cg Tolerance — Y Axis	_____ ±mm	_____ ±in.
Cg Tolerance — Z Axis	_____ ±mm	_____ ±in.
Fundamental Natural Frequency — Longitudinal	_____ Hz	_____ Hz
Cg — Thrust Axis (Origin at Separation Plane)	_____ mm	_____ in.
PROPULSION SYSTEM 1		
Propellant Type		
Propellant Mass, nominal	_____ kg	_____ lbm
Propellant Fill Fraction	_____ %	_____ %
Propellant Density	_____ kg/m <sup>3</sup>	_____ lbm/ft <sup>3</sup>
Propellant Tank Material		
Propellant Tank Location (SC Coordinates) Station Azimuth		
Diameter	_____ mm	_____ in
Shape		
Internal Volume	_____ m <sup>3</sup>	_____ ft <sup>3</sup>
Capacity	_____ m <sup>3</sup>	_____ ft <sup>3</sup>
Internal Description		
Operating Pressure — Flight	_____ kg/mm <sup>2</sup>	_____ lb/in <sup>2</sup>
Operating Pressure — Ground	_____ kg/mm <sup>2</sup>	_____ lb/in <sup>2</sup>
Design Burst Pressure — Calculated	_____ kg/mm <sup>2</sup>	_____ lb/in <sup>2</sup>
Factor of Safety (Design Burst/Ground Maximum Expected Operating Pressure [MEOP])		
Proof Pressure — Test	_____ kg/mm <sup>2</sup>	_____ lb/in <sup>2</sup>
Actual Burst Pressure — Test	_____ kg/mm <sup>2</sup>	_____ lb/in <sup>2</sup>
Pressure When ULA Personnel are Exposed	_____ kg/mm <sup>2</sup>	_____ lb/in <sup>2</sup>
Number of Vessels Used		
PRESSURIZED TANK 1		
Purpose		
Vessel Contents		
Tank Material		
Capacity — Launch	_____ kg	_____ lbm

Table 4.5.1-1: Spacecraft Information Worksheet (4 of 6)

Spacecraft Design Parameter	SI Units	English Units
PRESSURIZED TANK 1 CONTINUED		
Fill Fraction	_____ %	_____ %
Operating Pressure — Flight	_____ kg/mm <sup>2</sup>	_____ lb/in <sup>2</sup>
Operating Pressure — Ground	_____ kg/mm <sup>2</sup>	_____ lb/in <sup>2</sup>
Design Burst Pressure — Calculated	_____ kg/mm <sup>2</sup>	_____ lb/in <sup>2</sup>
Factor of Safety (Design Burst/Ground MEOP)		
Proof Pressure — Test	_____ kg/mm <sup>2</sup>	_____ lb/in <sup>2</sup>
Actual Burst Pressure — Test	_____ kg/mm <sup>2</sup>	_____ lb/in <sup>2</sup>
Pressure When ULA Personnel are Exposed	_____ kg/mm <sup>2</sup>	_____ lb/in <sup>2</sup>
PAYLOAD BATTERY 1		
Battery Type		
Battery Capacity	_____ mAh	_____ mAh
Electrolyte		
Cell Pressure Vessel Material		
Number of Cells		
Average Voltage/Cell	_____ v	_____ v
Cell Pressure (Ground MEOP)	_____ kg/mm <sup>2</sup>	_____ lb/in <sup>2</sup>
Specification Burst Pressure	_____ kg/mm <sup>2</sup>	_____ lb/in <sup>2</sup>
Actual Burst	_____ kg/mm <sup>2</sup>	_____ lb/in <sup>2</sup>
Proof Tested	_____ kg/mm <sup>2</sup>	_____ lb/in <sup>2</sup>
Back Pressure Control (BPC) Type		
TRANSMITTERS AND RECEIVERS		
Nominal Frequency	_____ MHz	
Transmitter Tuned Frequency	_____ MHz	
Receiver Frequency	_____ MHz	
Data Rates, Downlink	_____ kbps	
Symbol Rates, Downlink	_____ kbps	
Type of Transmitter		
Transmitter Power, Maximum	_____ dBm	
Losses, Minimum	_____ dB	
Peak Antenna Gain	_____ dB	
Antenna Gain 90 deg Off Boresight	_____ dB	
EIRP, Maximum	_____ dBm	
Antenna Location (Base) Station (in.) Azimuth (deg) Radius (in.)		
1 mW/cm <sup>2</sup> Distances (Personnel Safety)		
Planned Operation: Prelaunch: in Building _____ Pre-Launch: Pre-Fairing Installation Post-Launch: Before Payload Separation		

Table 4.5.1-1: Spacecraft Information Worksheet (5 of 6)

Spacecraft Design Parameter	SI Units	English Units
<b>ELECTRO EXPLOSIVE DEVICES</b>		
Quantity		
Type		
Use		
Firing Current	_____ amps	_____ amps
Bridgewire		
Installed Where		
Connected Where		
Armed Where		
<b>NON-ELECTRIC ORDNANCE AND RELEASE DEVICES</b>		
Quantity		
Type		
Use		
Quantity Explosives		
Explosives		
Installed Where		
Connected Where		
Armed Where		
<b>CONTAMINATION SENSITIVE SURFACES</b>		
Component		
Sensitive to		
<b>CONTAMINATION REQUIREMENTS</b>		
Fairing Air Cleanliness	_____ Class	_____ Class
Maximum Molecular Deposition on SC Surfaces	_____ Angstroms	N/A
Maximum Particulate Deposition on SC Surfaces	_____ % obs	_____ % obs.
Out Gassing — Total Weight Loss	_____ %	_____ %
Out Gassing — Volatile Condensable Material Weight Loss	_____ %	_____ %
<b>SPACECRAFT DESIGN SAFETY FACTORS</b>		
Airborne Pressure Vessel Burst Safety Factor		
Airborne Pressure System Burst Safety Factor		
Structural Limit (Yield) Safety Factor		
Structural Ultimate Safety Factor		
Battery Burst Safety Factor		
<b>SPACECRAFT QUALIFICATION TEST PROGRAM</b>		
Acoustic Qualification	_____ +dB	_____ +dB
Sine Vibration Qualification Safety Factor		
Shock Qualification Safety Factor		
Loads Qualification Safety Factor		

Table 4.5.1-1: Spacecraft Information Worksheet (6 of 6)

Spacecraft Design Parameter	SI Units	English Units
ORBIT INJECTION CONDITIONS		
Range of Separation Velocity	_____ m/s	_____ ft/s
Max Angular Rate at Separation-Roll	_____ rpm	_____ rpm
Max Angular Rate Uncertainty-Roll	_____ ±rpm	_____ ±rpm
Max Angular Rate at Separation — Pitch & Yaw	_____ rpm	_____ rpm
Max Angular Rate Uncertainty — Pitch & Yaw	_____ ±rpm	_____ ±rpm
Max Angular Acceleration	_____ rad/s <sup>2</sup>	_____ rad/s <sup>2</sup>
Max Pointing Error Requirement	_____ deg	_____ deg
Max Allowable Tip-Off Rate	_____ deg/s	_____ deg/s
Coefficients of Inertia — Ixx (x=Thrust Axis)	_____ kg m <sup>2</sup>	_____ slug ft <sup>2</sup>
Coefficients of Inertia — Ixx Tolerance	_____ ±kg m <sup>2</sup>	_____ ±slug ft <sup>2</sup>
Coefficients of Inertia — Iyy	_____ kg m <sup>2</sup>	_____ slug ft <sup>2</sup>
Coefficients of Inertia — Iyy Tolerance	_____ ±kg m <sup>2</sup>	_____ ±slug ft <sup>2</sup>
Coefficients of Inertia — Izz	_____ kg m <sup>2</sup>	_____ slug ft <sup>2</sup>
Coefficients of Inertia — Izz Tolerance	_____ ±kg m <sup>2</sup>	_____ ±slug ft <sup>2</sup>
Coefficients of Inertia — Ixy	_____ kg m <sup>2</sup>	_____ slug ft <sup>2</sup>
Coefficients of Inertia — Ixy Tolerance	_____ ±kg m <sup>2</sup>	_____ ±slug ft <sup>2</sup>
Coefficients of Inertia — Iyz	_____ kg m <sup>2</sup>	_____ slug ft <sup>2</sup>
Coefficients of Inertia — Iyz Tolerance	_____ ±kg m <sup>2</sup>	_____ ±slug ft <sup>2</sup>
Coefficients of Inertia — Ixz	_____ kg m <sup>2</sup>	_____ slug ft <sup>2</sup>
Coefficients of Inertia — Ixz Tolerance	_____ ±kg m <sup>2</sup>	_____ ±slug ft <sup>2</sup>



**Table 4.5.1-2: Mission Requirements**

Type of Data	Scope of Data
Number of Launches* Frequency of Launches*	
Spacecraft Orbit Parameters Including Tolerances (Park Orbit, Transfer Orbit)*	<ul style="list-style-type: none"> <li>• Apogee Altitude</li> <li>• Perigee Altitude</li> <li>• Inclination</li> <li>• Argument of Perigee</li> <li>• RAAN</li> </ul>
Launch Window and Flight Constraints  Pre-Separation Function*	<ul style="list-style-type: none"> <li>• Acceleration Constraints (Pitch, Yaw, Roll)</li> <li>• Attitude Constraints</li> <li>• Spinup Requirements</li> <li>• Prearm</li> <li>• Arm</li> <li>• Spacecraft Equipment Deployment Timing and Constraints</li> <li>• Solar Illumination Constraints</li> </ul>
Separation Parameters (Including Tolerances)*	<ul style="list-style-type: none"> <li>• Desired Spin Axis</li> <li>• Angular Rate of Spacecraft</li> <li>• Orientation (Pitch, Yaw and Roll Axis)</li> <li>• Origin of Coordinate System (Location)</li> <li>• Acceleration Constraints</li> <li>• Spacecraft Operational Considerations in Proximity of Separation event</li> </ul>
Any Special Trajectory Requirements	<ul style="list-style-type: none"> <li>• Boost Phase</li> <li>• Coast Phase</li> <li>• Free Molecular Heating Constraints</li> <li>• Thermal Maneuvers</li> <li>• Separation Within View of Telemetry and Tracking Ground Station</li> <li>• Telemetry Dipout Maneuvers</li> <li>• Real Time Retransmission</li> </ul>
<p><u>Note:</u> * Information desired at initial meeting between ULA and customer after contract award.</p>	

Table 4.5.1-3: Spacecraft Characteristics (1 of 2)

Type of Data	Scope of Data
Configuration Drawings*	<ul style="list-style-type: none"> <li>• Drawings Showing the Configuration, Shape, Dimensions and Protrusions near the Mechanical Interface (Ground Launch and Deployment Configurations)</li> <li>• Coordinates (Spacecraft Relative to Launch Vehicle)</li> <li>• Special Clearance Requirements</li> </ul>
Apogee Kick Motor*	<ul style="list-style-type: none"> <li>• Manufacturer's Designation</li> <li>• Thrust</li> <li>• Specific Impulse</li> <li>• Burn Action Time</li> <li>• Propellant Offload Limit</li> </ul>
Mass Properties (Launch and Orbit Configurations)*	<ul style="list-style-type: none"> <li>• Weight — Specify Total, Separable &amp; Retained Masses</li> <li>• Center of Gravity — Specify in 3 Orthogonal Coordinates Parallel to the Booster Roll, Pitch and Yaw Axes for Total, Separable and Retained Masses</li> <li>• Changes in Center of Gravity Due to Deployment of Appendages</li> <li>• Propellant Slosh Models</li> </ul>
Moments and Products of Inertia (Launch and Orbit Configurations)	<ul style="list-style-type: none"> <li>• Specify About the Axes Through the Spacecraft Center of Gravity That Are Parallel to the Atlas Roll, Pitch and Yaw Axes for Total, Separable, and Retained Masses</li> </ul>
Structural Characteristics	<ul style="list-style-type: none"> <li>• Spring Ratio of Structure</li> <li>• Elastic Deflection Constants</li> <li>• Shear Stiffness</li> <li>• Dynamic Model</li> <li>• Bending Moments and Shear Loads at Atlas/Centaur/Spacecraft Interface</li> <li>• Limitations, Include Acoustic, Shock, Acceleration, Temperature and Bending Moments</li> </ul>
Dynamic Model for 3-D Loads Analysis	<ul style="list-style-type: none"> <li>• Generalized Stiffness Matrix (Ref Paragraph 4.5.3.2 for Details)</li> <li>• Generalized Mass Matrix</li> <li>• Description of the Model, Geometry and Coordinate System</li> <li>• Loads Transformation Matrix</li> </ul> <p><u>Note:</u> Models must include rigid body and normal modes.</p>
Handling Constraints	<ul style="list-style-type: none"> <li>• Spacecraft Orientation During Ground Transport</li> <li>• Spacecraft Handling Limits (e.g., Acceleration Constraints)</li> </ul>
Spacecraft Critical Orientations	<ul style="list-style-type: none"> <li>• Location and Direction of Antennas during Checkout, Prelaunch and Orbit</li> <li>• Location, Look Angle and Frequency of Sensors</li> <li>• Location and Size of Solar Arrays</li> </ul>
Thermal Characteristics	<ul style="list-style-type: none"> <li>• Spacecraft Thermal Math Model (Ref Sect. 4.5.3.3)</li> <li>• Emissivity and Solar Absorptivity</li> <li>• Conductivity</li> <li>• Thermal Constraints (Maximum and Minimum Allowable Temperatures)</li> <li>• Heat Generation (e.g., Sources, Heat Flux, Time of Operation)</li> </ul>
Contamination Control	<ul style="list-style-type: none"> <li>• Requirements for Ground-Supplied Services</li> <li>• In-Flight Conditions (e.g., During Ascent and After PLF Jettison)</li> <li>• Surface Sensitivity (e.g., Susceptibility to Propellants, Gases, and Exhaust Products)</li> </ul>
RF Radiation	<ul style="list-style-type: none"> <li>• Transmitter Characteristics (e.g., Power Levels, Frequency, Antenna Gain, and Operational Timeline for Checkout and Flight Configuration)</li> <li>• Receiver Characteristics (e.g., Operational Sensitivity Levels, Damage Levels, Filter Attenuation, Antenna Gain, Frequency, and Operational Timeline)</li> <li>• Locations (e.g., Location of Receivers, Transmitters and Antennas on Spacecraft)</li> <li>• Checkout Requirements (e.g., Open-Loop, Closed-Loop, Prelaunch, Ascent Phase)</li> <li>• Number of and Type of Transmitter Inhibits</li> </ul>

**Table 4.5.1-3: Spacecraft Characteristics (2 of 2)**

Type of Data	Scope of Data
Safety Items	<ul style="list-style-type: none"> <li>• General Systems Description</li> <li>• Basic Spacecraft Mission</li> <li>• Prelaunch Through Launch Configuration</li> <li>• Orbital Parameters</li> <li>• Functional Subsystems</li> <li>• Hazardous Subsystems</li> <li>• Ground Operations Flow</li> <li>• Flight Hardware Descriptions (Safety-Oriented)</li> <li>• Structural/Mechanical Subsystems</li> <li>• Propellant/Propulsion Subsystems</li> <li>• Pressurized Subsystems</li> <li>• Ordnance Subsystems</li> <li>• Electrical and Electronic Subsystems</li> <li>• Non-ionizing Radiation Subsystems (RF/Laser)</li> <li>• Ionizing Radiation Subsystems</li> <li>• Hazardous Materials</li> <li>• Thermal Control Subsystems</li> <li>• Acoustical Subsystems</li> </ul> <p><u>Note:</u> Hazard identification/controls/verification method summaries for each subsystem.</p> <ul style="list-style-type: none"> <li>• Ground Support Equipment (GSE) Descriptions</li> <li>• Mechanical GSE</li> <li>• Propellant/Propulsion GSE</li> <li>• Pressure GSE</li> <li>• Ordnance GSE</li> <li>• Electrical GSE</li> <li>• RF/Laser GSE</li> <li>• Ionizing Radiation GSE</li> <li>• Hazardous Materials GSE</li> </ul> <p><u>Note:</u> Hazard identification/controls/verification method summaries for each item.</p> <ul style="list-style-type: none"> <li>• Ground Operations</li> <li>• Hazardous Ground Operations</li> <li>• Procedures</li> <li>• Transport Configuration</li> </ul>
<p><u>Note:</u> For each safety data submittal — identify each item/operation applicable to PPF, HPF, or launch site as applicable.</p>	
<p><u>Note:</u> * Information desired at initial meeting between ULA and customer after contract award.</p>	

**Table 4.5.1-4: Interface Requirements (Mechanical) (1 of 2)**

Type of Data	Scope of Data
Mechanical Interfaces *	<ul style="list-style-type: none"> <li>• Base Diameter of Spacecraft Interface*</li> <li>• Structural Attachments at Spacecraft Interface*</li> <li>• Required Accessibility to Spacecraft in Mated Condition*</li> <li>• Extent of Equipment Remaining with Adapter After Spacecraft Separation*</li> <li>• Degree of Environmental Control Required</li> <li>• Spacecraft Pressurization, Fueling System Connector Type and Location</li> <li>• Timeline for Pressure/Fuel System Operation</li> <li>• Spacecraft/Adapter Venting Requirements</li> </ul>

**Table 4.5.1-4: Interface Requirements (Mechanical) (2 of 2)**

Type of Data	Scope of Data
PLF Requirements	<ul style="list-style-type: none"> <li>• Heating Constraints</li> <li>• Venting Characteristics (e.g., Quantity, Timing and Nature of Gases Vented from Spacecraft)</li> <li>• RF Reradiation System (RF Band, Spacecraft Antenna Location, etc)</li> <li>• PLF Separation (e.g., Altitude, Cleanliness, Shock, Aeroheating and Airload Constraints)</li> <li>• Acoustic Environment Constraints</li> <li>• Special Environmental Requirements</li> </ul>
Preflight Environment	<ul style="list-style-type: none"> <li>• PLF Separation (e.g., Altitude, Cleanliness, Shock, Aeroheating and Airload Constraints)</li> <li>• Acoustic Environment Constraints</li> <li>• Special Environmental Requirements</li> <li>• Requirements                             <ul style="list-style-type: none"> <li>– Cleanliness</li> <li>– Temperature and Relative Humidity</li> <li>– Air Conditioning</li> <li>– Air Impingement Limits</li> </ul> </li> <li>• Monitoring and Verification Requirements</li> </ul>
Umbilical Requirements	<ul style="list-style-type: none"> <li>• Separation from Launch Vehicle</li> <li>• Flyaway at Launch</li> <li>• Manual Disconnect (Including When)</li> </ul>
Materials	<ul style="list-style-type: none"> <li>• Special Compatibility Requirements</li> <li>• Out Gassing Requirements</li> </ul>
<p><u>Note:</u> * Information desired at initial meeting between ULA and customer after contract award.</p>	

**Table 4.5.1-5: Interface Requirements (Electrical) (1 of 2)**

Type of Data	Scope of Data
Power Requirements (Current, Duration, Function Time, and Tolerances)*	<ul style="list-style-type: none"> <li>• 28-Vdc Power</li> <li>• Other Power</li> <li>• Overcurrent Protection</li> </ul>
Command Discrete Signals*	<ul style="list-style-type: none"> <li>• Number*</li> <li>• Sequence</li> <li>• Timing (Including Duration, Tolerance, Repetition Rate, etc)</li> <li>• Voltage (Nominal and Tolerance)</li> <li>• Frequency (Nominal and Tolerance)</li> <li>• Current (Nominal and Tolerance)</li> <li>• When Discretes Are for EED Activation, Specify:                             <ul style="list-style-type: none"> <li>– Minimum, Maximum and Nominal Fire Current</li> <li>– Minimum and Maximum Resistance</li> <li>– Minimum Fire Time</li> <li>– Operating Temperature Range</li> <li>– Manufacturer's Identification of Device</li> </ul> </li> </ul>
Other Command & Status Signals	<ul style="list-style-type: none"> <li>• Status Displays</li> <li>• Abort Signals</li> <li>• Range Safety Destruct</li> <li>• Inadvertent Separation Destruct</li> </ul>
Ordnance Circuits	<ul style="list-style-type: none"> <li>• Safe/Arm Requirements</li> </ul>

**Table 4.5.1-5: Interface Requirements (Electrical) (2 of 2)**

Type of Data	Scope of Data
Telemetry Requirements*	<ul style="list-style-type: none"> <li>• Spacecraft Measurements Required To Be Transmitted by Atlas Telemetry:                             <ul style="list-style-type: none"> <li>– Quantity</li> <li>– Type of Measurements (e.g., Temperature, Vibration, Pressure, etc);</li> <li>– Details Concerned with Related System Including Operating Characteristics (Response Definition of System) and Locations and Anticipated Time of Operation; Impedance, Capacitance, Operating Range and Full-Scale Range of Each Measurement</li> </ul> </li> <li>• Signal Conditioning Requirements (e.g., Input Impedance, Impedance Circuit Load Limits, Overcurrent Protection and Signal-to-Noise Ratio)</li> <li>• Discrete Events (Bilevel)</li> <li>• Analog Measurements</li> <li>• Transducers Required To Be Furnished by Launch Vehicle Contractor</li> <li>• Minimum Acceptable Frequency Response for Each Measurement</li> <li>• Minimum Acceptable System Error for Each Measurement (Sampling Rate is Also Governed by This Requirement)</li> <li>• Period of Flight for Which Data from Each Measurement Are of Interest (e.g., from Liftoff to Spacecraft Separation)*</li> <li>• Atlas Flight Data Required by Spacecraft Contractor</li> </ul>
Bonding	<ul style="list-style-type: none"> <li>• Bonding Requirements at Interface (MIL-B-5087, Class R for Launch Vehicle)</li> <li>• Material and Finishes at Interface (for Compatibility with Launch Vehicle Adapter)</li> </ul>
EMC	<ul style="list-style-type: none"> <li>• Test or Analyze Spacecraft Emissions and Susceptibility</li> <li>• EMC Protection Philosophy for Low-Power, High-Power and Pyrotechnic Circuits</li> <li>• Launch Vehicle, Transport and Site Emissions (Provided by ULA)</li> </ul>
Grounding Philosophy	<ul style="list-style-type: none"> <li>• Structure (e.g., Use of Structural As Ground and Current Levels)</li> <li>• Electrical Equipment (e.g., Grounding Method for Signals and Power Supplies)</li> <li>• Single-Point Ground (e.g., Location and Related Equipment)</li> </ul>
Interface Connectors	<ul style="list-style-type: none"> <li>• Connector Item (e.g., Location and Function)*</li> <li>• Connector Details</li> <li>• Electrical Characteristics of Signal on Each Pin</li> </ul>
Shielding Requirements	<ul style="list-style-type: none"> <li>• Each Conductor or Pair</li> <li>• Overall</li> <li>• Grounding Locations for Termination</li> </ul>
<p><b>Note:</b> * Desired for initial integration meeting with ULA after contract award.</p>	

**Table 4.5.1-6: Test and Launch Operations (1 of 2)**

Type of Data	Scope of Data
Spacecraft Launch Vehicle Integration	<ul style="list-style-type: none"> <li>• Sequence from Spacecraft Delivery Through Mating with the Launch Vehicle</li> <li>• Handling Equipment Required</li> <li>• ULA-Provided Protective Covers or Work Shields Required</li> <li>• Identify the Space Envelope, Installation, Clearance, and Work Area Requirements</li> <li>• Any Special Encapsulation Requirements Support Services Required</li> </ul>
Space Access Requirements	<ul style="list-style-type: none"> <li>• Access for Spacecraft Mating and Checkout</li> <li>• Access During Transportation to the Launch Pad and Erection Onto the Atlas V</li> <li>• Access for Checkout and Achieving Readiness Prior to Fairing Installation</li> <li>• Access After Fairing Installation; State SC Access Location, Number of Personnel, Scope, Equipment Entry</li> <li>• Access During the Final Countdown, if Any</li> <li>• GSE Requirements for Emergency Removal</li> </ul>
Hardware Needs (Including Dates)*	<ul style="list-style-type: none"> <li>• Electrical Simulators</li> <li>• Structural Simulators</li> <li>• Master Drill Gage*</li> </ul>

Table 4.5.1-6: Test and Launch Operations (2 of 2)

Type of Data	Scope of Data
Umbilicals	<ul style="list-style-type: none"> <li>• Ground Servicing Umbilicals by Function and Location in Excess of Atlas/Centaur Baseline</li> <li>• Structural Support Requirements and Retraction Mechanisms</li> <li>• Installation (e.g., When and by Whom Supplied and Installed)</li> </ul>
Spacecraft Environmental Protection (Preflight)	<ul style="list-style-type: none"> <li>• Environmental Protection Requirements by Area, Including Cleanliness Requirements:                             <ul style="list-style-type: none"> <li>– Spacecraft Room</li> <li>– Transport to Launch Pad</li> <li>– Mating</li> <li>– Inside PLF</li> <li>– During Countdown</li> </ul> </li> <li>• Air-Conditioning Requirements for Applicable Area (Pad Area) by:                             <ul style="list-style-type: none"> <li>– Temperature Range</li> <li>– Humidity Range</li> <li>– Particle Limitation</li> <li>– Impingement Velocity Limit</li> </ul> </li> <li>• Indicate if Spacecraft Is Not Compatible with Launch Vehicle Propellants and What Safety Measures Will Be Required</li> <li>• Environmental Monitoring and Verification Requirements</li> </ul>
Commodities Required for Both Spacecraft, AGE & Personnel	<ul style="list-style-type: none"> <li>• Gases, Propellants, Chilled Water and Cryogenics in Compliance with Ozone-Depleting Chemicals Requirements</li> <li>• Source (e.g., Spacecraft or Launch Vehicle)</li> <li>• Commodities for Personnel (e.g., Work Areas, Desks, Phones)</li> </ul>
Miscellaneous	Spacecraft Guidance Alignment Requirements
Interface Test Requirements	<ul style="list-style-type: none"> <li>• Structural Test</li> <li>• Fit Test</li> <li>• Compatibility Testing of Interfaces (Functional)</li> <li>• EMC Demonstration (Integrated System Test)</li> <li>• Launch Vehicle / Spacecraft RF Interface Test</li> <li>• Environmental Demonstration Test</li> </ul>
Launch Operations	<ul style="list-style-type: none"> <li>• Detailed Sequence &amp; Time Span of All Spacecraft-Related Launch Site Activities Including:                             <ul style="list-style-type: none"> <li>– AGE Installation</li> <li>– Facility Installation and Activities,</li> <li>– Spacecraft Testing and Spacecraft Servicing</li> </ul> </li> <li>• Recycle Requirements</li> <li>• Launch Operations Restrictions Including:                             <ul style="list-style-type: none"> <li>– Launch Site Activity Limitations</li> <li>– Constraints on Launch Vehicle Operations</li> <li>– Security Requirements</li> <li>– Personnel Access Limitations and Safety Precautions</li> </ul> </li> <li>• Special Requirements Include Handling of Radioactive Materials, Security and Access Control</li> <li>• Support Requirements to Include Personnel, Communications and Data Reduction</li> <li>• Launch and Flight Requirements for Real-Time Data Readout, Post-flight Data Analysis, Data Distribution, Post-flight Facilities</li> </ul>
<p><b>Note:</b> * Desired for initial integration meeting with ULA after contract award.</p>	

**Table 4.5.1-7: Ground Equipment and Facility Requirements (Electrical)**

Type of Data	Scope of Data
Spacecraft Electrical Conductor Data	SC System Schematic Showing All Connectors Required Between SC Equipment, & SC Terminal Board Position or Receptacle Pin Assigned to Each Conductor; Electrical Characteristics of Each Connector Including Maximum End-to-End Resistance, Shielding, Capacitance & Spare Conductors
Electrical Power (AGE & Facility)	<ul style="list-style-type: none"> <li>• Frequency, Voltage, Watts, Tolerance, Source</li> <li>• Isolation Requirements</li> <li>• Identify if Values Are Steady or Peak Loads</li> <li>• High-Voltage Transient Susceptibility</li> </ul>
RF Transmission	<ul style="list-style-type: none"> <li>• Antenna Requirements (e.g., Function, Location, Physical Characteristics, Beam Width &amp; Direction &amp; Line-of-Sight)</li> <li>• Frequency &amp; Power Transmission</li> <li>• Operation</li> </ul>
Cabling	<ul style="list-style-type: none"> <li>• All Cabling, Ducting, or Conduits To Be Installed in the Mobile Service Tower or VIF;</li> <li>• Who Will Supply, Install, Checkout &amp; Remove</li> </ul>
Monitors & Controls	<ul style="list-style-type: none"> <li>• Specify Which Signals from Spacecraft Are To Be Monitored During Readiness &amp; Countdown;</li> <li>• Specify Signal Power Source (Spacecraft, Atlas V, Centaur)</li> <li>• Transmission Method (e.g., Spacecraft Telemetry, Launch Vehicle Telemetry, Landline, or Launch Vehicle Readiness Monitor)</li> <li>• Location of Data Evaluation Center, Evaluation Responsibility, Measurement Limits and Go/No-Go Constraints;</li> <li>• Identify Where in the Operational Sequence Measurements Are To Be Monitored and Evaluated;</li> <li>• Specify Frequency and Duration of Measurements</li> <li>• Video Output Characteristics of Telepaks (if Available) for Closed-Loop Prelaunch Checkout at the Launch Pad;</li> <li>• Data to Include Location and Type of Interface Connector(s), and Characteristics of Signal at Source;</li> <li>• This Includes Voltage Level, Output Impedance, Output Current Limitation, Maximum Frequency of Data Train and Output Loading Requirements</li> </ul>

**4.5.2 Spacecraft Design Requirements**

Table 4.5.2-1 lists specific requirements that should be certified by analysis and/or test by the SC agency to be compatible for launch with Atlas/Centaur. ULA works with the customer to resolve the incompatibility should the SC not meet any of these requirements.

**Table 4.5.2-1: Spacecraft Design Elements to Be Certified by Analysis or Test (1 of 2)**

Spacecraft Design Requirement	Comment
<b>Mechanical</b>	
<ul style="list-style-type: none"> <li>• Payload Fairing Envelope</li> </ul>	Section 6
<ul style="list-style-type: none"> <li>• Payload Adapter Envelope</li> </ul>	Section 6
<ul style="list-style-type: none"> <li>• Payload Adapter Interface</li> </ul>	Section 5
<b>Electrical</b>	
<ul style="list-style-type: none"> <li>• Two or Fewer Separation Commands</li> </ul>	Section 5.2
<ul style="list-style-type: none"> <li>• 16 or Fewer Control Commands (28-V Discrettes or Dry Loop)</li> </ul>	Section 5.2
<ul style="list-style-type: none"> <li>• Instrumentation Interface, 2 or Fewer Inputs for SC Separation Detection, 4 or Fewer Analog Inputs for General Use; 10 or Fewer Cmd Feedback Discrettes, 2 or Fewer Serial Data I/F for Downlinking SC Data</li> </ul>	Section 5.2
<ul style="list-style-type: none"> <li>• Two Umbilical Connectors at SC Interface</li> </ul>	Section 5.2.1

**Table 4.5.2-1: Spacecraft Design Elements to Be Certified by Analysis or Test (2 of 2)**

Spacecraft Design Requirement	Comment
<b>Structure &amp; Loads</b>	
• Design Load Factors	Table 3.2.1 and Figure 3.2.1-1
• First Lateral Modes Above 8 Hz & First Axial Mode Above 15 Hz	Section 3.2.1
• Spacecraft Mass vs cg Range	Section 5
• Design FS per Applicable Range Safety Documentation & MIL-STD-1522 (or Submit Deviations for Review)	
<b>Environment</b>	
• Spacecraft Test Requirements	Section 3.3
• Quasi-Sinusoidal Vibration	Figures 3.2.3-1
• Acoustic Levels in the PLF	Figures 3.2.2-1 Through 3.2.2-3 and Tables 3.2.2-1 and 3.2.2-2
• Shock Induced by PLF Jettison & Spacecraft Separation	Figures 3.2.4-1 Through 3.2.4-2
• Payload Compartment Pressures & Depressurization Rates	Figures 3.2.6-1 Through 3.2.6-5
• Gas Velocity Across SC Components 9.75 m/s (32 ft/s)	4-m PLF
• Gas Velocity Across SC Components 10.67 m/s (35 ft/s)	5-m PLF
• Electric Fields	Figures 3.1.2.1-1 Through 3.1.2.1-2
• Spacecraft Radiation Limit	Figure 3.1.2.4-1
• EM Environment at Launch Range	Section 3.1.2.3
<b>Safety</b>	
• All Spacecraft Propellant Fill and Drain Valves, All Pressurant Fill and Vent Valves Readily Accessible When Spacecraft Is Fully Assembled and Serviced in Launch Configuration (Encapsulated and on Launch Pad)	It Is Advisable to Accommodate Normal Servicing/Deservicing and Potential Emergency Backout Situation for New Spacecraft Design
• Requirements in Range Safety Regulation	
<b>Miscellaneous</b>	
• See Atlas Launch Services Facilities Guide for Spacecraft Propellants and Specifications Available at Launch Site Fuel Storage Depot	
<u>Note:</u> Compliance with ozone-depleting chemicals regulation is required.	

**4.5.3 Spacecraft Integration Inputs**

Table 4.5.3-1 lists typical SC inputs required for the integration process, the approximate need date, and a brief description of the contents. Further details on some items are provided in the following sections.

**Table 4.5.3-1: Spacecraft Inputs to Integration Process (1 of 2)**

Spacecraft Data Input	Typical Need Date	Comments
Interface Requirements Document	Program Kickoff	See Section 4.5.1
Initial Target Specification	Program Kickoff	Spacecraft Weight, Target Orbit, Separation Attitude; See Section 4.5.3.4
Range Safety Mission Orientation Briefing Input	Program Kickoff	Top-Level Description of Spacecraft & Mission Design
Prelim Spacecraft MSPSP	Program Kickoff	See Section 4.5.3.6.1
Intact Impact Breakup Data	Program Kickoff	See Section 4.5.3.6.4.2
In-Flight Breakup Data	Program Kickoff	See Section 4.5.3.6.4.3
CAD Model	30 days After Program Kickoff	See Section 4.5.3.1
Procedures Used at Astrotech	2 month Before SC Arrival	See Section 4.5.3.6.2
Procedures Used on CCAFS	4 month Before Launch	See Section 4.5.3.6.2
Thermal Models	5 month Before Design Review	See Section 4.5.3.3



**Table 4.5.3-1: Spacecraft Inputs to Integration Process (2 of 2)**

Spacecraft Data Input	Typical Need Date	Comments
Preliminary Launch Windows	6 month Before Design Review	Support Thermal Analysis; See Section 4.5.3.3
Coupled Loads Model	6 month Before Design Review	See Section 4.5.3.2
Spacecraft EMI/EMC Cert Letter	6 month Before Launch	See Section 4.5.3.5
Spacecraft EED Analysis	6 month Before Launch	See Section 4.5.3.5
Final Target Specification	90 days Before Launch	Date Depends on Mission Design; See Section 4.5.3.4
Spacecraft Environment Qualification Test Reports	As Available	See Table 4.5.2-1 for Environment Qualification Requirements

**4.5.3.1 Computer-Aided Design Data Transfer Requirements**

The Atlas V program uses both the UNIX- and MS Windows-based operating systems and uses the Parametric Technology Corporation (PTC) Pro-Engineer (Pro-E) CAD program. CAD data should be provided according to this specified software format. When feasible, ULA prefers to receive solid or surface model data translated through the Standard for the Exchange of Product Model Data (STEP) converter. An alternative to this would be the equivalent in an Initial Graphics Exchange Specification (IGES) 4.0 or higher file format. Wireframe geometry may be included with the solid or surface model transfer.

**4.5.3.1.1 Prerequisites to Data Transfer**

The following criteria should be met by the SC contractor before transferring CAD data:

1. Verify that the data files contain the desired results by reading them back onto the originating CAD system from the source file before transmittal to ULA.
2. Provide entire representation of all external SC components for best integration to the Atlas LV. All internal structures are not necessary and should be removed from model transfer files.
3. Write out the Pro-E, STEP, and/or IGES model files as assemblies and not as a single part file. Ensure that the total SC model transfer does not exceed 150 MB in an uncompressed file size.
4. Remove all non-essential geometry such as points, axis lines, and lines-of-action before creating the data.
5. Ensure ITAR license agreements are met.

If feasible, the entire directory should be compressed and transferred as a single file using (UNIX) Tar (tar cvf/dev/rmt0 part name), or (Windows) "WinZip" or equivalent.

**4.5.3.1.2 Data Transfer**

Compact disk, DVD media, and/or a ULA-based electronic file server (i.e., iDM LiveLink or File Transfer Protocol [FTP]) are the preferred transfer methods for all data files. An account can be established on a ULA firewall server for electronic data transfers. An alternative method would involve the contractor providing similar access to one of their systems via a temporary account. In either case, the transfer type should be set to binary. If using an FTP server, proprietary or sensitive data should be encrypted using Pretty Good Privacy (PGP) keys or equivalent. Because of security concerns, email transfers are not recommended at this time. If CDROM, DVD or electronic transfer methods are not feasible, contact appropriate ULA personnel listed in the Preface to provide a coordinated and acceptable method of data transfer.

The following information must be sent with the CAD data regardless of transfer method:

1. SC models security status must be clearly marked and communicated (Proprietary Data, Third-Party Proprietary, Non-public Space Vehicle Information [NPSVI], etc.)
2. Name and phone number of the contact person who is familiar with the model in case problems or questions arise
3. SC axis and coordinate system
4. SC access requirements for structure not defined on CAD model (i.e. fill and drain valve locations)
5. Multiview plot or jpeg(s) file of model
6. Uudecode (UNIX-based) information, if applicable

#### 4.5.3.2 Coupled-Loads Analysis Model Requirements

The customer-supplied dynamic mathematical model of the SC should consist of generalized mass and stiffness matrices, and a recommended modal damping schedule. The desired format is Craig-Bampton, constrained at the Centaur interface in terms of SC modal coordinates and discrete Centaur interface points. The SC dynamic model should have an upper frequency cutoff of 90 to 100 Hz. The Output Transformation Matrices (OTM) should be in the form that, when multiplied by the SC modal and interface generalized coordinate responses, will recover the desired accelerations, displacements, or internal loads. One of the OTMs should contain data that will allow calculation of loss of clearance between the payload fairing and critical points on the SC. Typically, the size of the OTMs is 200 to 500 rows for accelerations, 50 to 200 rows for displacements, and 300 to 1,000 rows for internal loads.

#### 4.5.3.3 Spacecraft Thermal Analysis Input Requirements

SC geometric and thermal mathematical models are required to perform the integrated thermal analysis. These models should be delivered electronically or on a computer diskette with printed listings of all the files. The Geometric Mathematical Model (GMM) and Thermal Mathematical Model (TMM) size should be less than 2,000 nodes/surfaces each.

The preferred GMM format is Thermal Desktop input format. Alternate formats are Thermal Radiation Analysis System (TRASYS), TSS, or NEVADA input formats. The documentation of the GMM should include illustrations of all surfaces at both the SC and component levels, descriptions of the surface optical properties, and the correspondences between GMM and TMM nodes.

The preferred TMM format is System-Improved Numerical Differencing Analyzer (SINDA). The TMM documentation should include illustrations of all thermal modeling; detailed component power dissipations for prelaunch, ascent, and on-orbit mission phases; steady state and transient test case boundary conditions, output to verify proper conversion of the input format to ULA analysis codes; maximum and minimum allowable component temperature limits; and internal SC convection and radiation modeling.

In addition to the TMM and GMM, launch window open and close times for the entire year are required inputs to the integrated thermal analysis.

#### 4.5.3.4 Target Specifications

Target specifications normally include the final mission transfer orbit (apogee and perigee radii, argument of perigee, and inclination), SC mass, and launch windows. The final target specification is due to ULA 90 days before launch for missions incorporating Minimum Residual Shutdown (MRS) or In-Flight Retargeting (IFR), and 60 days before launch for guidance commanded-shutdown GCS missions.

#### **4.5.3.5 Spacecraft Electromagnetic Interference and Electromagnetic Compatibility Certification Letter and Electroexplosive Device Analysis**

A final confirmation of SC transmitter and receiver parameters, and emission and susceptibility levels of electronic systems is required 6 months before launch. This includes consideration of emissions from such electronic equipment as internal clocks, oscillators, and signal or data generators; and likelihood of electronics and items such as Electro-Explosive Devices (EED) to cause upset, damage, or inadvertent activation. These characteristics are to be considered according to MIL-STD-1541 requirements to assure that appropriate margins are available during launch operations. ULA will use the SC data to develop a final analysis for the combined SC/LV and site environment.

#### **4.5.3.6 Safety Data**

To launch from CCAFS on the Eastern Range or VAFB on the Western Range, SC design and ground operations must meet the applicable launch-site safety regulations. Section 4.3.1 lists these regulations. Mission-specific schedules for development and submittal of the SC safety data will be coordinated in safety working group meetings during the safety integration process. Section 4.3.2 contains additional information on this process.

##### **4.5.3.6.1 Missile System Prelaunch Safety Package**

The Missile System Prelaunch Safety Package (MSPSP) is the data package that describes in detail the hazardous and safety-critical SC systems/subsystems, their interfaces, and the associated Ground Support Equipment (GSE). In addition, the SC MSPSP provides verification of compliance with the applicable Range Safety requirements. The SC MSPSP must be approved by Range Safety before the arrival of SC elements at the launch site.

##### **4.5.3.6.2 Spacecraft Launch Site Procedures**

Before any procedures are performed at the launch site, hazardous SC procedures must be approved by the Range Safety Office and/or the safety organization at the appropriate SC processing facility (e.g., Astrotech, NASA, and DoD). Since the approving authority must also concur with the nonhazardous designation of procedures, all SC launch-site procedures must be submitted for review. ULA's System Safety group is the point of contact for submittal/coordination of all SC data (refer to Section 4.3.2)

##### **4.5.3.6.3 Radiation Protection Officer Data**

Permission must be received from the Range Radiation Protection Officer (RPO) before SC RF emissions are allowed at the launch complex. The required RPO data includes descriptions of the equipment involved, the procedures that will be used, and information on the personnel who will be running the procedures.

##### **4.5.3.6.4 Spacecraft Breakup Data Requirements**

The SC data described in the following three subsections is required for the Atlas V program to complete mission-specific analyses that satisfy 45th Space Wing and 30th Space Wing requirements for submitting a request for Range Safety PFPA and FFPA.

###### **4.5.3.6.4.1 Inadvertent Spacecraft Separation and Propulsion Hazard Analysis**

This data set is related to inadvertent separation of the SC during early ascent and the potential for launch area hazards that could exist in the event SC engine(s) fire. Typical SC propulsion system data provided by the customer include the maximum tanked weight, maximum loaded propellant weight, maximum axial thrust (all motors), and maximum resultant specific impulse.

#### 4.5.3.6.4.2 Intact Impact Analysis

This data set is related to the ground impact of the SC. The intact impact analysis assumes ground impact of a fully loaded, fueled, intact SC. It also assumes propellants will combine and explode. Typical SC data provided by the customer include the types and weights of explosive propellants; estimates of the number of pieces of the SC that could break off in an explosion; and the location, size, weight, and shape of each piece.

#### 4.5.3.6.4.3 Destruct Action Analysis

This data set is related to the Flight Termination System (FTS) destruction of the LV. The destruct action analysis assumes in-flight destruction of the vehicle by detonation of the FTS ordnance. Typical SC data provided by the customer include an estimate of the number of SC pieces that could break off because of commanded vehicle destruction, estimates of the size, weight, and shape of each piece, and the location of each piece on the SC.

#### 4.5.3.7 Spacecraft Propellant Slosh Modeling

ULA models SC propellant slosh as part of the LV attitude control system stability analysis. The SC propellant tank geometry, tank locations, minimum and maximum tank fill levels, propellant densities, and propellant slosh damping ratios are required to perform this analysis. The data are documented in the mission specific ICD.

## 5. PAYLOAD INTERFACES

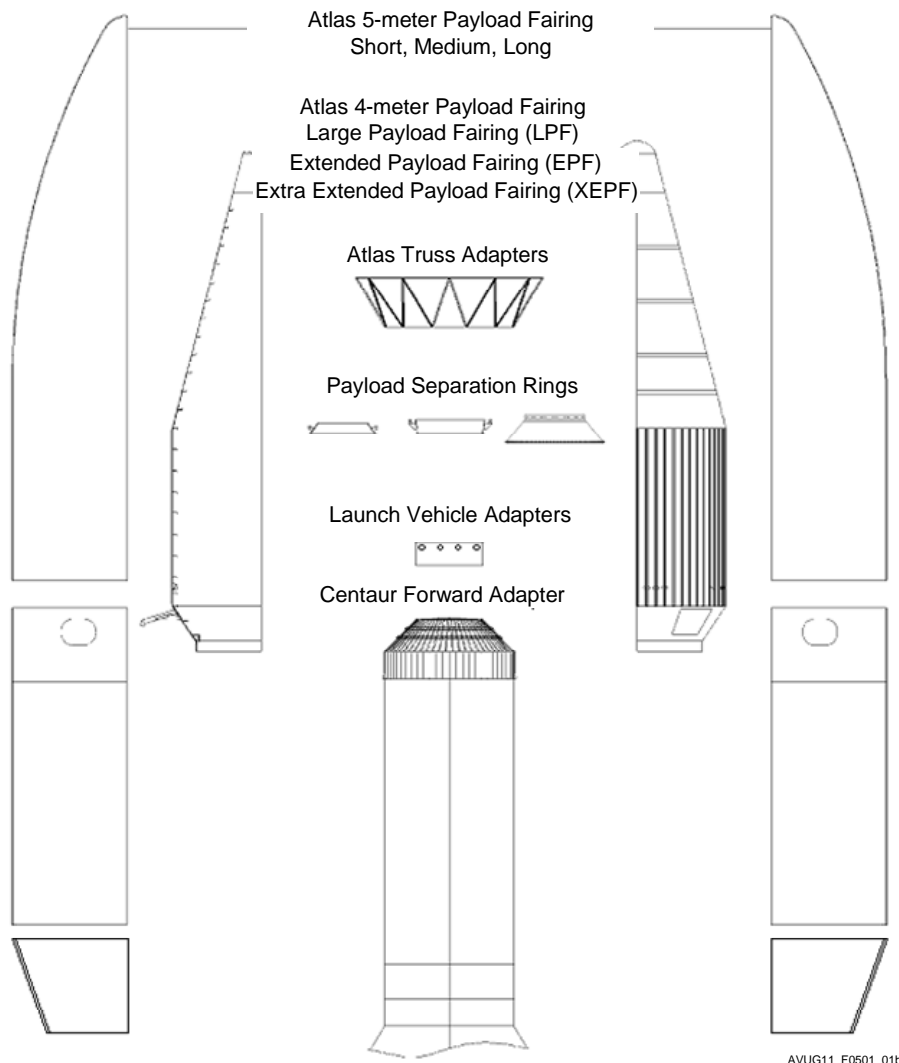
### 5.1 SPACECRAFT-TO-LAUNCH VEHICLE MECHANICAL INTERFACES

The Atlas V launch system interface designs meet the requirements of currently defined spacecraft (SC) and offer the flexibility to adapt to mission-unique needs. Primary interfaces between the Atlas V launch vehicle (LV) and the SC consist of a Payload Fairing (PLF) that encloses and protects the SC and a Payload Adapter (PLA) that supports the SC on top of the LV. These components are designed to provide mechanical and electrical interfaces required by the SC and to provide a suitable environment during integration and launch activities. Figure 5.1-1 shows the payload adapters and payload fairings offered in the Atlas V program.

The following sections summarize these payload adapter interface options. Section 6 contains detailed descriptions of the payload fairings. The interface information in the following sections should be used only as a guideline. Modifications to these systems may be accommodated on a mission-unique basis.

The Interface Control Document (ICD) governs ultimate control of interface information for a given mission. Section 4 discusses how the ICD is developed and maintained during the mission integration process.



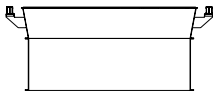
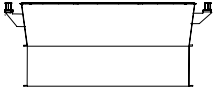
**Figure 5.1-1: Atlas V Payload Interface Options**



**5.1.1 Mechanical Interfaces**

The Atlas V offers a range of mechanical interface options including standardized bolted interfaces, payload adapters, and trusses that mate the SC to the LV. These options include provisions for mechanical and electrical interfaces between the LV and SC and for mission-unique services. Payload interface options include a bolted interface at the standard interface plane (SIP), Atlas V standard payload adapters that are designed to handle heavier SC taking advantage of the higher performance Atlas V vehicle, and truss adapters. Table 5.1.1-1 summarizes these SC interface options. The following sections describe these mechanical interfaces in detail.

**Table 5.1.1-1: Atlas V Payload Support Interface Options**

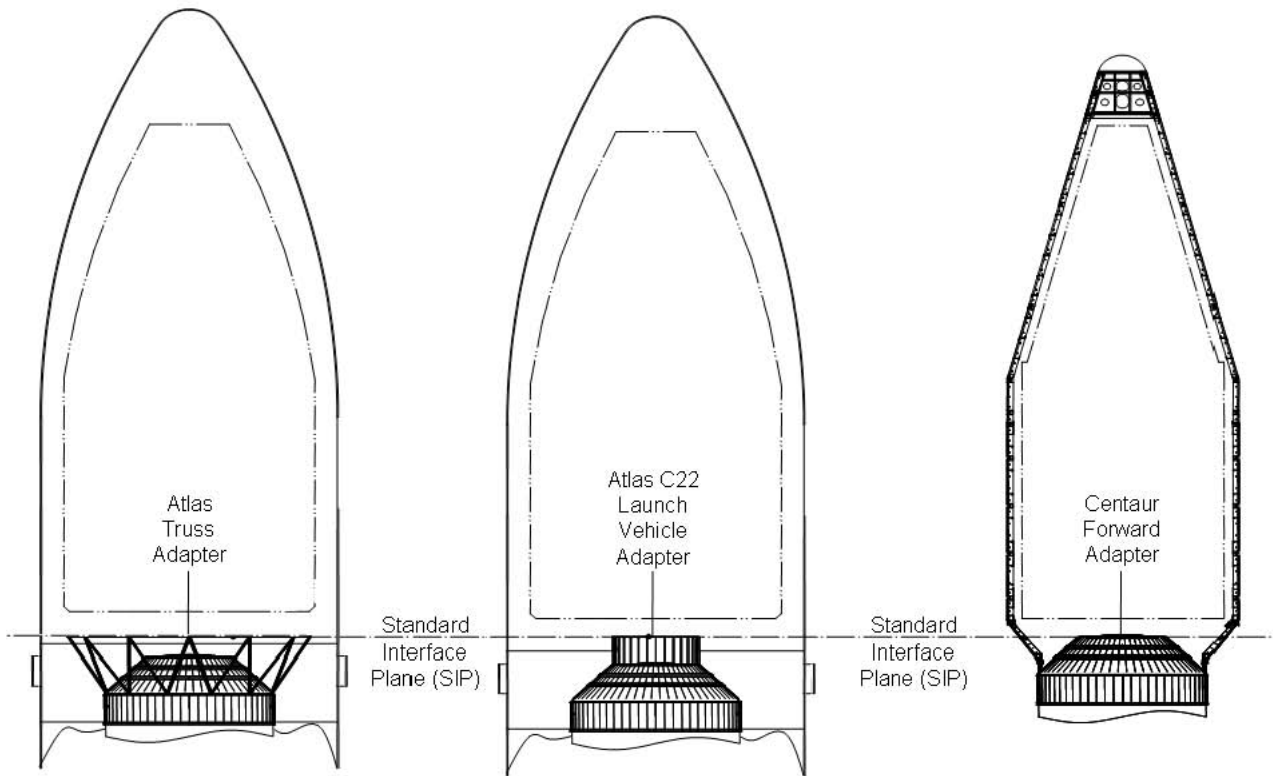
<b>Standard Interface Plane</b>		
SIP	Bolted Interface: 121 Fasteners Bolt Circle Diameter: 1,575.0 mm (62.010 in.)	Section 5.1.2
<b>Launch Vehicle Adapters</b>		
C13 C15 C22 C25 C29 Cxx - (Mission Unique)	Integrally Machined Cylindrical Aluminum Forging Bolted Interface: 120 or 121 Fasteners Bolt Circle Diameter: 1,575.0 mm (62.010 in.) Height: 330.2 mm to 736.6 mm (13 in. to 29 in.) Mass: 21.9 to 66.6 kg (48.4 to 146.9 lbs) See Section 2.5.1	Section 5.1.3
<b>Atlas V Standard Payload Adapters (PSR + LV adapter)</b>		
A937 	Integrally Machined Aluminum Forging Forward Ring Diameter: 945.3 mm (37.215 in.) Separation System: LSPSS937 Low-Shock Marmon Type Clampband Height: 736.6 to 1143 mm (29.00 to 45.00 in.) Mass: PSW: 69.7 to 114.4 kg (153.7 to 252.2 lbs) See Section 2.5.1	Section 5.1.4.2
B1194 	Integrally Machined Aluminum Forging Forward Ring Diameter: 1,215.0 mm (47.835 in.) Separation System: LSPSS1194 Low-Shock Marmon Type Clampband Height: 812.8 mm (32.00 in.) Standard; 584.2 to 990.6 mm (23 to 39 in.) Available Mass: PSW: 61.8 to 106.5 kg (136.2 to 234.8 lbs) See Section 2.5.1	Section 5.1.4.3
D1666 	Integrally Machined Aluminum Forging Separation System: LSPSS1666 Low-Shock Marmon-Type Clampband Forward Ring Diameter: 1,666.1 mm (65.594 in.) Height: 889.0 mm (35.00 in.) Standard; 660.4 to 1066.8 mm (26 to 42 in.) Available Mass: PSW: 61.4 to 106.1 kg (135.4 to 233.9 lbs) See Section 2.5.1	Section 5.1.4.4
F1663 	Separation System: Four Separation Nuts Four Hard Point Interface Diameter: 1,663 mm (65.50 in.) Height: 1109.4 mm (44.13 in.) Standard; 943.1 to 1298.7 mm (37.1 to 51.1 in.) Mass: PSW: 116.1 to 160.8 kg (256 to 354.5 lbs) See Section 2.5.1	Section 5.1.4.5
<b>Atlas V Truss Adapters</b>		
T4394 (173 in.)	Bolted Interface: 18 Places Forward Ring Bolt Circle Diameter: 4,394.2 mm (173.0 in.) Height: 1,168.4 mm (46.00 in.) Mass: 170 to 181.4 kg (375 to 400 lbs)	Section 5.1.5.1
T3302 (130 in.)	Bolted Interface: 14 Places Forward Ring Bolt Circle Diameter: 3,302.0 mm (130.0 in.) Height: 914.4 mm (36.00 in.) Mass: 170 to 181.4 kg (375 to 400 lbs)	Section 5.1.5.2

### 5.1.2 Atlas Standard Interface Plane

The reference plane for the SC-to-LV interface is the Atlas V SIP shown in Figure 5.1.2.-1. The Atlas V SIP provides a standardized bolted interface for Atlas V and customer-provided payload adapters. The SIP consists of a 1,575-mm (62.010-in.) bolt circle diameter machined ring that contains 121 bolt holes. For vehicles using a 4-m PLF, this plane is at the top of the Atlas V Centaur Forward Adapter. For vehicles using a 5-m PLF, this plane occurs at the top of an Atlas V program-provided C22 LV adapter that is mounted on top of the Centaur Forward Adapter. The C22 adapter is standard with the 5-m PLF to allow LV ground support equipment interfaces and is designed to provide an interface that is identical to that provided by the Centaur Forward Adapter. For 5-m PLF vehicles, the first C22 adapter is considered part of the basic LV and is not accounted for as Payload Systems Weight (PSW). For vehicles using a 5-m PLF and a LV-provided truss adapter, the C22 adapter is not typically used and the SIP plane occurs at the top of the truss.

For customers that provide their own payload adapter, the SIP is the interface point between the SC-provided hardware and the LV. If a customer-provided payload adapter is used with a 4-m PLF, it must provide interfaces for ground handling, encapsulation, and transportation equipment. In particular, there needs to be provisions for torus arm fittings and an encapsulation diaphragm unless a LV-supplied intermediate adapter (Type C Adapter) is used. Information on these interface requirements is in Atlas Specification S/M-00-025, "Torus Arm and Ground Transport Vehicle Interface Control Document for Payloads Using the 4-meter Payload Fairing," which is available on request to Atlas V customers.

Figure 5.1.2-1: Atlas V Standard Interface Plane

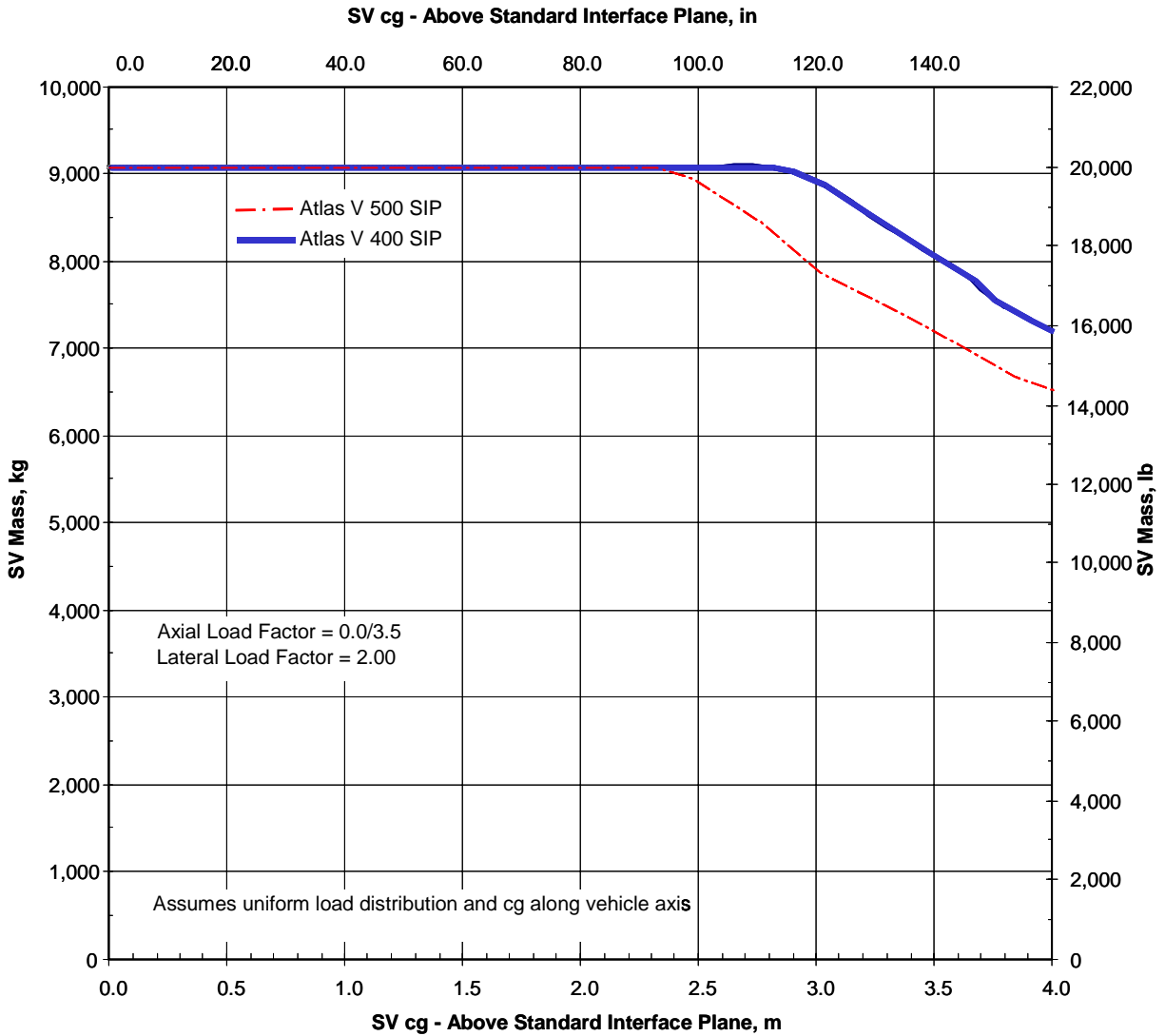


AVUG11\_F050102\_01a

5.1.2.1 Standard Interface Plane Structural Capabilities

Allowable SC weights and longitudinal Centers of Gravity (cg) for the 1,575-mm (62.010-in.) bolt circle diameter interface SIP are shown in Figure 5.1.2.1-1. The SC mass and cg capabilities were determined using generic SC interface ring geometry and quasi-static load factors (see Section 3.2.1). Actual SC design allowables may vary depending on interface ring stiffness and results of SC mission-unique coupled loads analyses. Coordination with the Atlas V program is required to define appropriate structural capabilities for SC designs that exceed these generic allowables.

Figure 5.1.2.1-1: Atlas V Standard Interface Plane Structural Capability (1,575-mm (62.010-in.) Bolt Circle Dia. Interface)

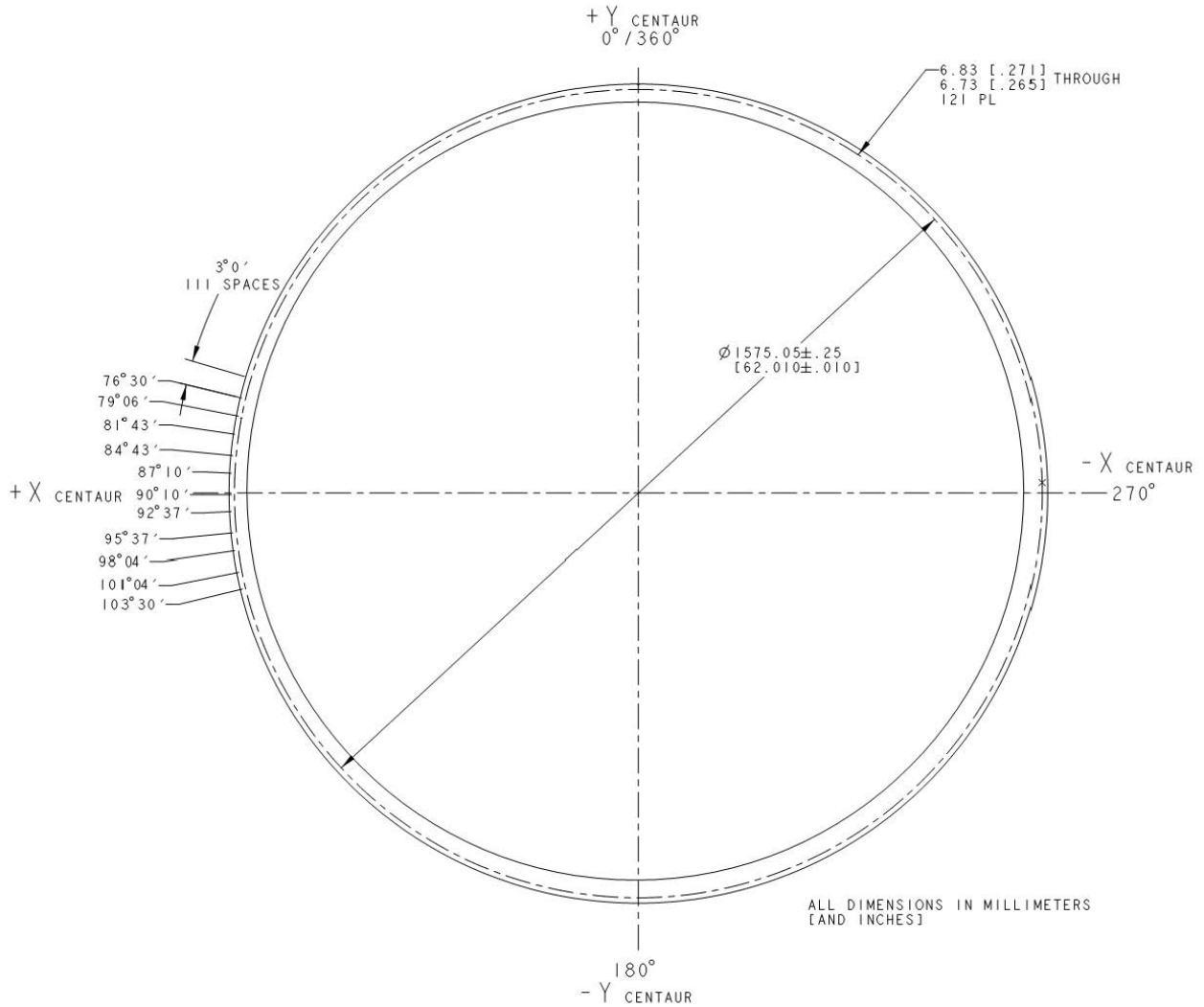




5.1.2.2 Standard Interface Plane Definition

Figure 5.1.2.2-1 shows the configuration and dimensional requirements for the Atlas V SIP. The bolthole pattern for this interface is controlled by Atlas V-provided tooling. This tooling is available to customers for fabrication of matching hardware as a part of mission integration activities.

Figure 5.1.2.2-1: Atlas V Standard Interface Plane Dimensional Requirements

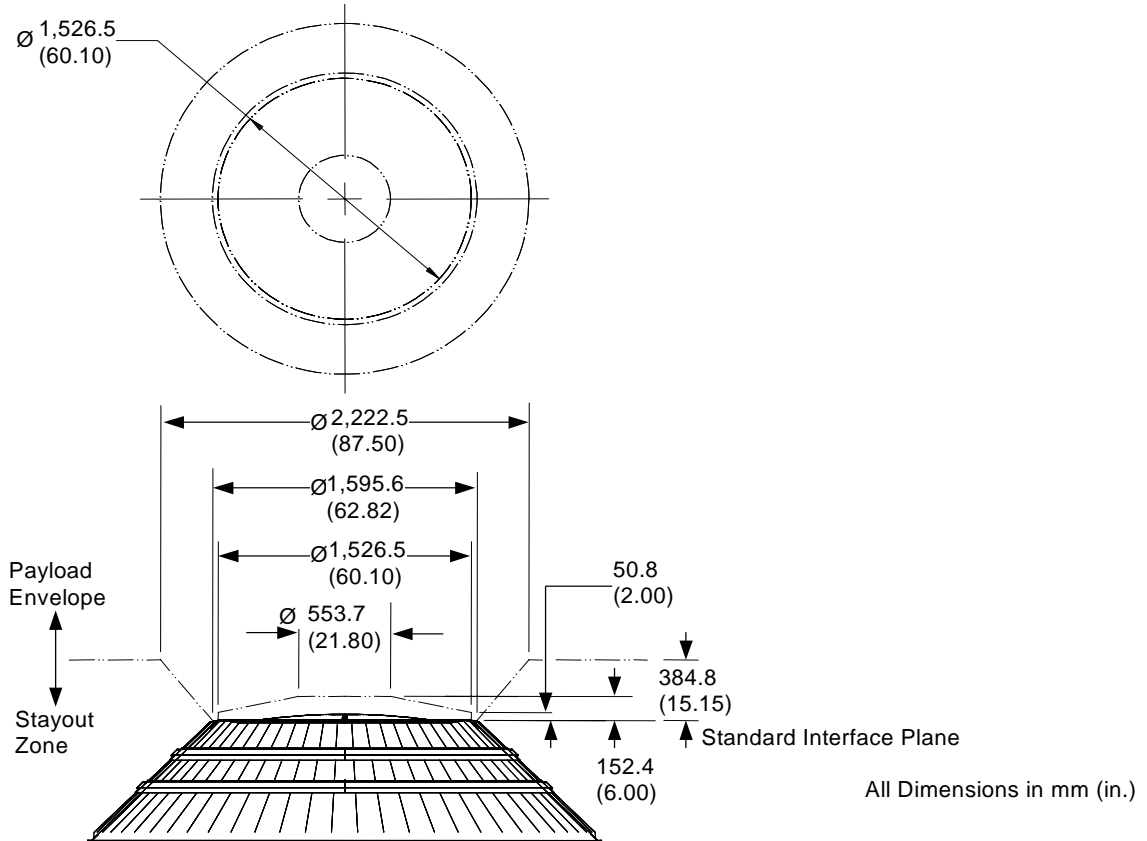


AVUG11\_F05010202\_01a

5.1.2.3 Static Payload Envelope

The static payload envelope defines the usable volume for the SC relative to the SIP. This envelope represents the maximum allowable SC static dimensions (including manufacturing tolerances) relative to the SC/payload adapter interface. This envelope design allows access to mating components for integration and installation operations and ensures positive clearance between LV and SC-provided hardware. Clearance layouts are created for each SC configuration, and if necessary, critical clearance locations are measured during SC-to-LV mate operations to ensure positive clearances. Figure 5.1.2.3-1 shows detailed views of the static payload envelope in the vicinity of the SIP.

Figure 5.1.2.3-1: Atlas V Standard Interface Plane Static Payload Envelope



AVUG11\_F05010203\_01b

5.1.3 Atlas V Launch Vehicle Adapters

The LV adapter, also known as a C-adapter, is a machined aluminum structure in a monocoque cylinder form. The forward and aft rings have an outer diameter of 1,596 mm (62.84 in.) and a bolt circle diameter of 1,575 mm (62.010 in) and can contain 120 or 121 bolt holes to meet Atlas V SIP requirements or to allow proper mating with the payload separation rings. The nominal height of the LV adapter is 558.8 mm (22.00 in.) but this height may be varied from 330.2 mm (13.00 in.) to 736.6 mm (29.00 in.) to meet mission-unique requirements. The LV adapter includes all provisions for mating to the LV ground support equipment, including the torus arms and isolation diaphragm, used during ground processing operations. The Atlas V LV adapters were developed to provide a common interface for LV required ground support equipment that interfaces with payload adapter systems. Atlas V C13, C15, C22, C25, and C29 LV adapter characteristics are summarized in Table 5.1.3-1.

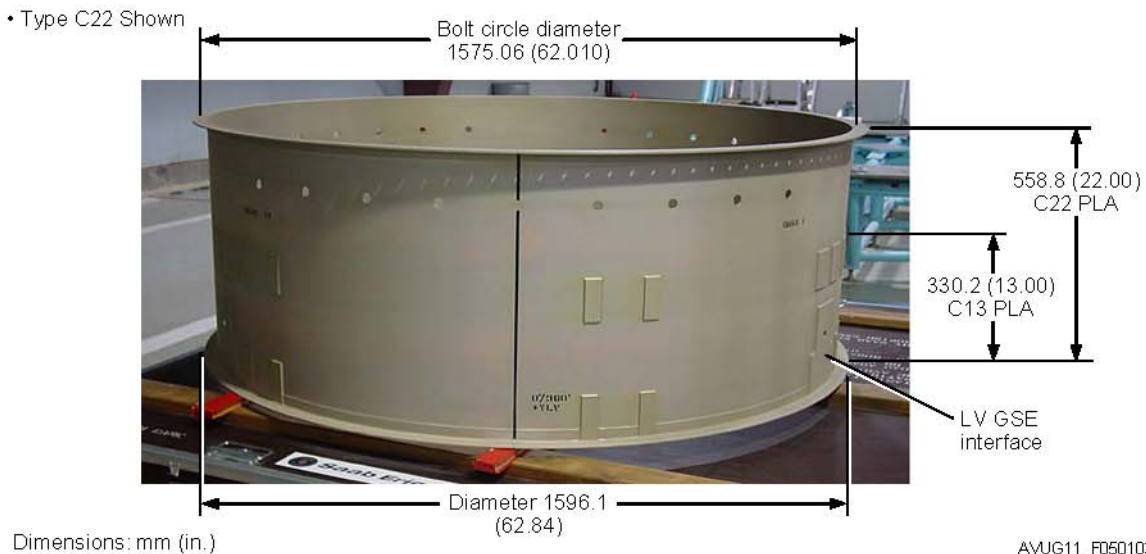
Table 5.1.3-1: Atlas V Adapters

Atlas V Launch Vehicle Adapters	
Construction	Integrally Machined Aluminum Construction
Mass Properties	See Section 2.5.1
Standard Height (LV)	
C13	330.2-mm (13.00-in.)
C15	384.8-mm (15.15-in.)
C22	558.8-mm (22-in.)
C25	634.9-mm (25-in.)
C29	736.3-mm (29-in)
Structural Capability (Figure 5.1.3-1)	6,300 kg at 2.5 m (13,890 lb at 98.5 in.)

On the Atlas V 500 series LV, the C22 LV adapter (shown in Figure 5.1.3-1) is mounted to the top of the Atlas V Centaur forward adapter and provides an interface surface and bolt hole pattern at its forward end that can be compatible with SIP requirements. The C22 adapter is standard with the 5-m PLF to allow clearance for LV ground support equipment. In this configuration, cost and performance impacts of the C22 LV adapter are considered a part of the basic LV service and are not accounted for as PSW.

For customers that provide their own payload adapter and payload separation system, LV adapters are available as a mission-unique option. This allows the customer to raise the position of the SIP relative to the LV for additional clearance or to take advantage of standard GSE interfaces that are built into the LV adapter.

Figure 5.1.3-1: Atlas V Launch Vehicle Adapter Configuration

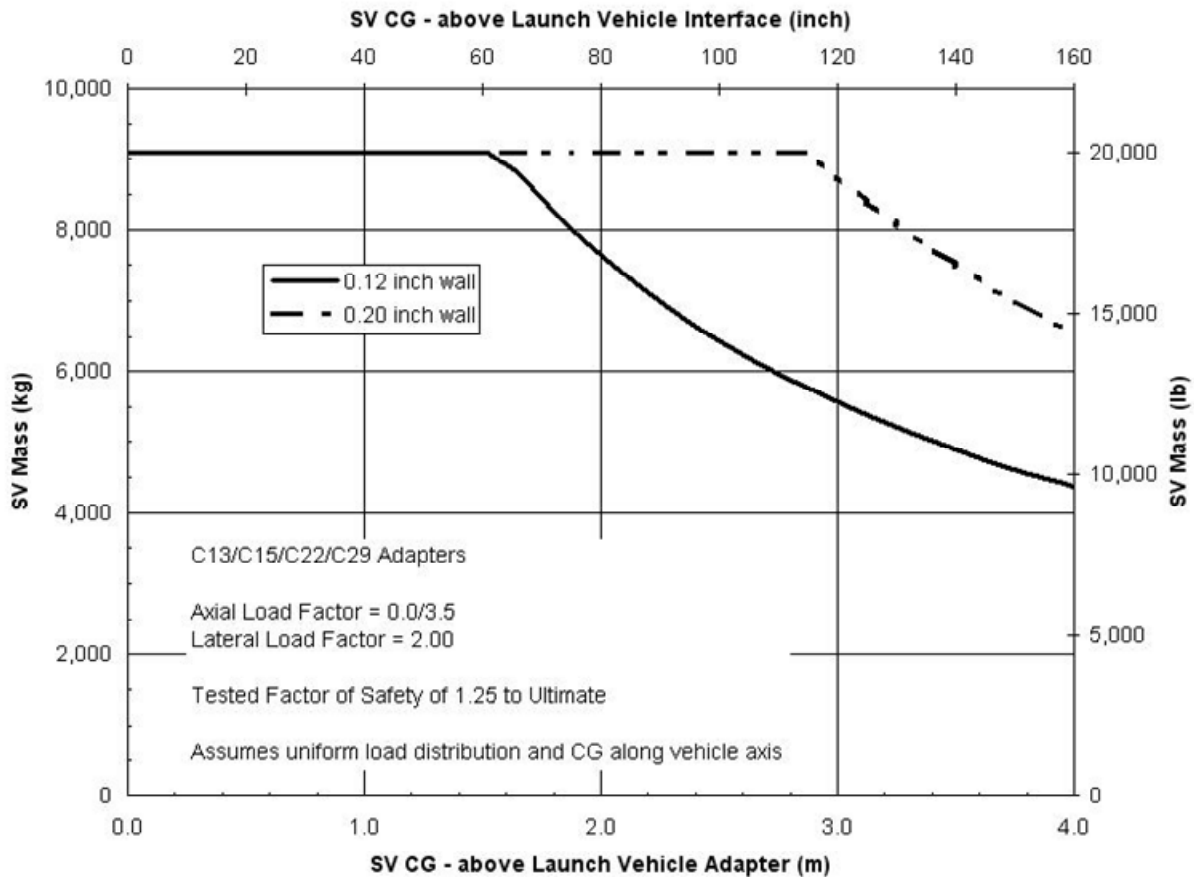


AVUG11\_F050103\_01 a

**5.1.3.1 Launch Vehicle Adapter Structural Capabilities**

Allowable SC weights and longitudinal centers of gravity for LV adapters are shown in Figure 5.1.3.1-1. These SC mass and center of gravity capabilities were determined using generic SC interface ring geometry and quasi-static load factors (see Section 3.2.1). Actual SC design allowables may vary depending on interface ring stiffness and results of SC mission-unique coupled loads analyses. Coordination with the Atlas V program is required to define appropriate structural capabilities for SC designs that exceed these generic allowables. Additional LV adapter structural capability or lighter weight adapters are available on a mission unique basis.

**Figure 5.1.3.1-1: Atlas Launch Vehicle Adapter Structural Capability**

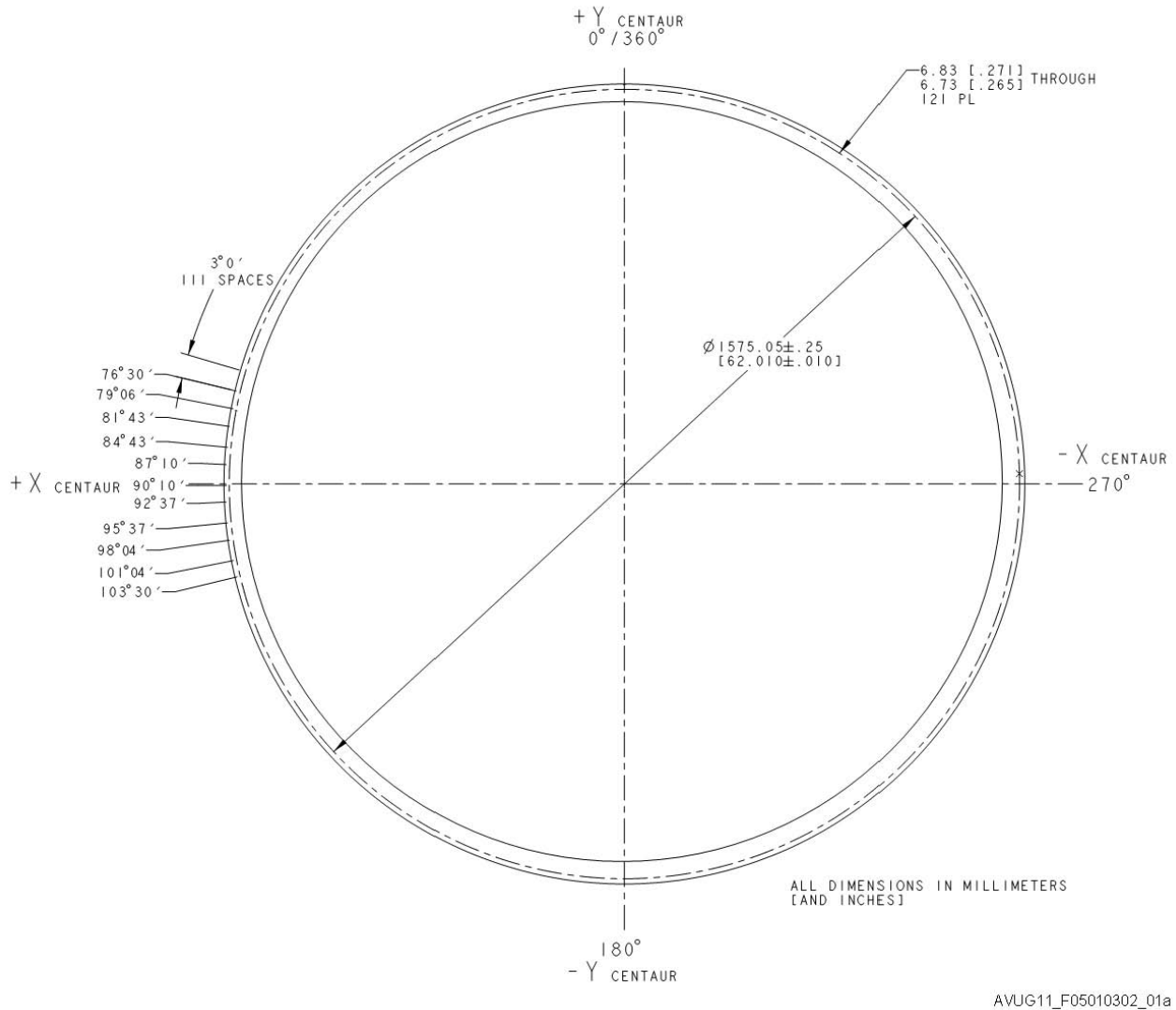


AVUG11\_F05010301\_01c

**5.1.3.2 Launch Vehicle Adapter Interfaces**

Figure 5.1.3.2-1 shows the configuration and dimensional requirements for Atlas V LV adapter interfaces. Atlas V-provided tooling controls the hole pattern for this interface. This tooling is available to customers for fabrication of matching hardware as a part of mission integration activities. Alternative hole patterns for this interface can be incorporated on a mission-unique basis.

Figure 5.1.3.2-1: Atlas Launch Vehicle Adapter Interface Requirements



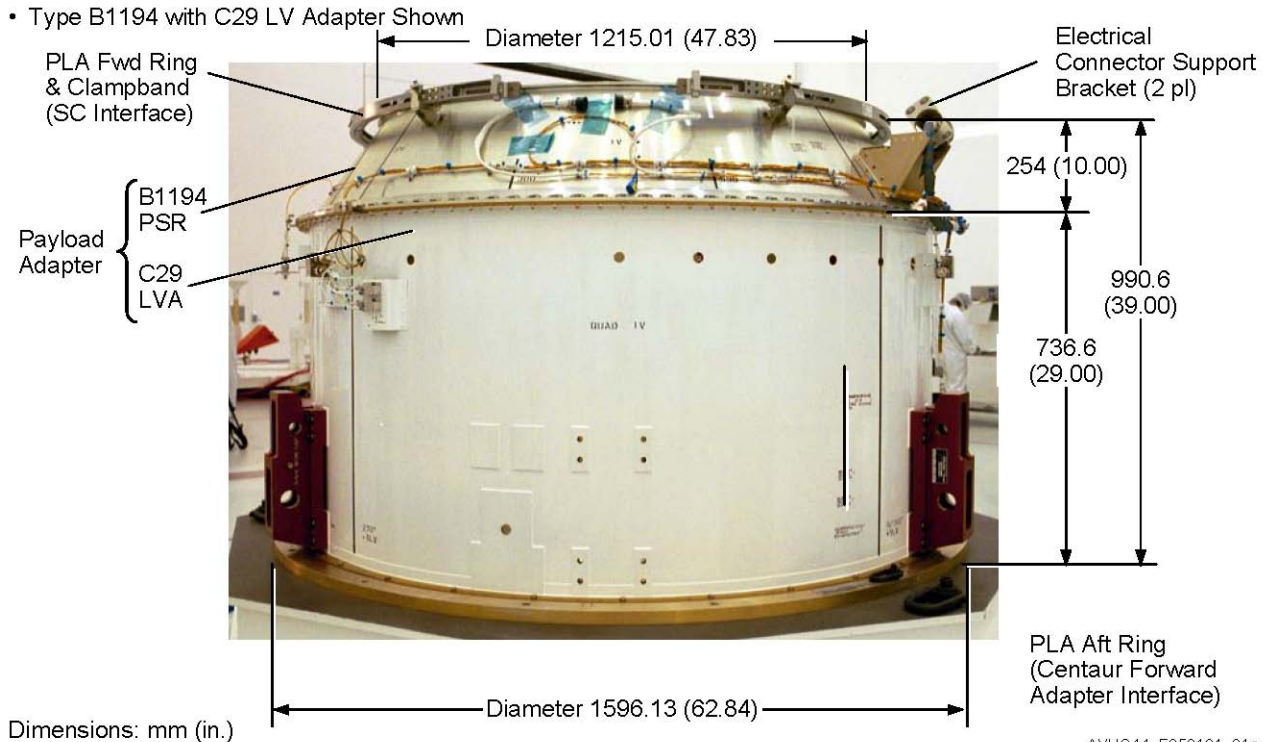
### 5.1.4 Atlas V Standard Payload Adapters

The Atlas V standard payload adapter designs can handle heavier SC to take advantage of the higher performance of the Atlas V vehicle. The available systems include the Atlas V Type A937, B1194, and D1666 payload adapters.

These payload adapters consist of three major components: the Payload Separation Ring (PSR) the LV adapter described in Section 5.1.3 and the payload separation system. A typical LV adapter is shown in Figure 5.1.4-1.

The PSR is a machined aluminum component in the form of a truncated cone. The forward ring forms the SC separation plane. The aft ring has an outer diameter of 1,596-mm (62.84 in.) and a bolt circle diameter of 1,575.06 mm (62.010 in). The PSR contains 120 evenly spaced bolt holes that allow it to be joined to the LV adapter. This symmetrical bolt hole pattern allows the payload separation ring and attached SC to be rotated relative to the LV in 3-degree increments to meet mission-unique requirements. The PSR supports all hardware that directly interfaces with SC including the payload separation system, electrical connectors, and mission-unique options.

**Figure 5.1.4-1: Atlas V Standard Payload Adapter Configuration — PSR with LV Adapter**

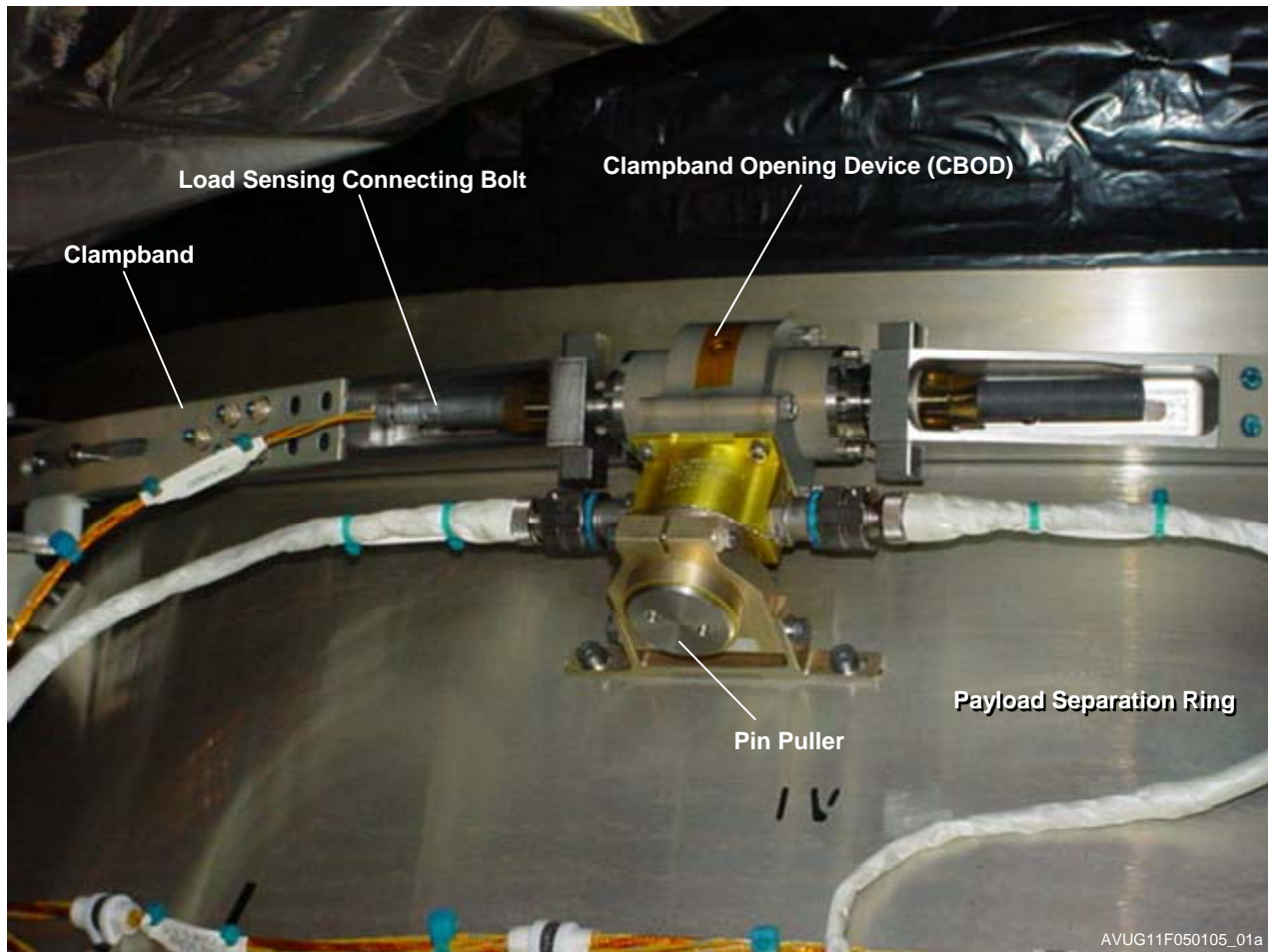


**5.1.4.1 Payload Separation System**

Atlas V payload adapters use a LV-provided, low-shock, Marmon-type clampband payload separation system. Figure 5.1.4.1-1 shows this separation system, which consists of a clampband set, release mechanism, and separation springs. The clampband set consists of a clampband for holding the SC and adapter rings together plus devices to catch and retain the clampband on the adapter structure after separation. The clampband includes aluminum clamp segments that hold the payload adapter and SC rings together and a single-piece aluminum retaining band that holds the clamp segments in place. The ends of the retaining band are held together by the low shock Clamp-Band Opening Device (CBOD). The CBOD includes release bolts that engage the ends of the clampband. These release bolts are threaded into a flywheel mechanism. During installation and flight, the flywheel is restrained against rotation by a restraining pin. For separation, a pyrotechnically-activated pin-puller retracts this pin from the flywheel, allowing it to rotate and eject the release bolts. This separation system reduces shock compared to a conventional bolt-cutter system and is resettable, allowing the actual flight hardware to be tested during component qualification and acceptance testing.

Separation spring assemblies provide the necessary separation energy after the clampband is released and are mounted to the payload adapter forward ring and bear on the SC aft ring. Positive SC separation is detected through continuity loops installed in the SC electrical connector and wired to the upper-stage instrumentation for monitoring and telemetry verification.

Figure 5.1.4.1-1: Atlas V Low-Shock Payload Separation System Configuration



**5.1.4.2 Atlas V Type A937 Payload Adapter**

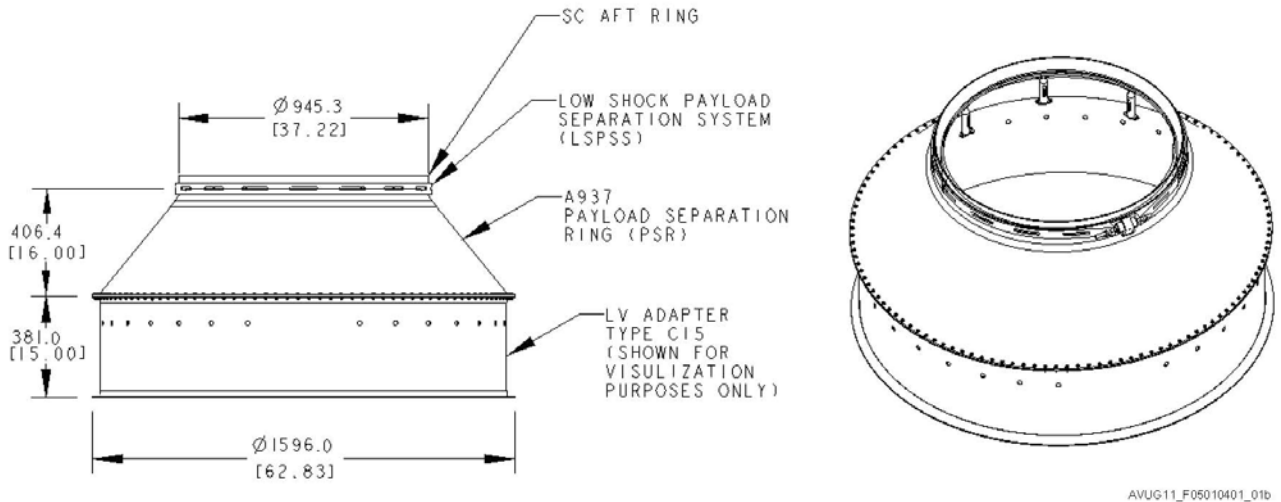
The Atlas V Type A937 payload adapter is designed to support SC with an aft ring diameter of 937 mm (37 in.). The Type A937 payload adapter replaces the previously flown Type A payload adapter. Table 5.1.4.2-1 summarizes the major characteristics of this payload adapter.

The Type A937 payload adapter (Figure 5.1.4.2-1) consists of two major sections: the payload separation ring (with separation system) and the LV adapter described in Section 5.1.3. The payload separation ring is a machined aluminum component in the form of a 406.4 mm (16-in.) high truncated cone. The forward ring has an outer diameter of 945 mm (37.215 in.) and forms the SC separation plane. The aft ring has an outer diameter of 1,596 mm (62.84 in.) and contains 120 evenly spaced bolt holes that allow it to be joined to the LV adapter. This symmetrical bolt hole pattern allows the payload separation ring and attached SC to be rotated relative to the LV in 3-degree increments to meet mission-unique requirements. The payload separation ring supports all hardware that directly interfaces with SC, including the payload separation system, electrical connectors, and mission-unique options.

**Table 5.1.4.2-1: Atlas V Type A937 Payload Adapter Characteristics\***

Atlas V Type A937 Payload Adapter	
Construction	Two-Piece, Integrally Machined Aluminum Construction
Mass Properties	See Section 2.5.1
Structural Capability (Figure 5.1.3.1.2-1)	6,300 kg at 1.1 m (13,890 lbs at 43.3 in.)
P/L Sep System	LSPSS937
Max Shock Levels	4,500 G (Section 3.2.4)
Clampband Preload — Installation	45.2 +0.5/ -0 kN (10,161 +112/-0 lb)
Clampband Preload — Flight	40.0 ± 0.5 kN (8,992 ± 112 lb)
Separation Springs	
Number	4, 6 or 8
Force per Spring — Max	1 kN (225 lb)
*capabilities to be verified during the qualification test program in mid 2010	

**Figure 5.1.4.2-1: Atlas V Type A937 Payload Adapter**



**5.1.4.2.1 Payload Separation System**

The Atlas Type A937 payload adapter uses a LV-provided, Marmon-type clampband payload separation system as described in detail in section 5.1.4.1.

**5.1.4.2.2 Payload Adapter Structural Capabilities**

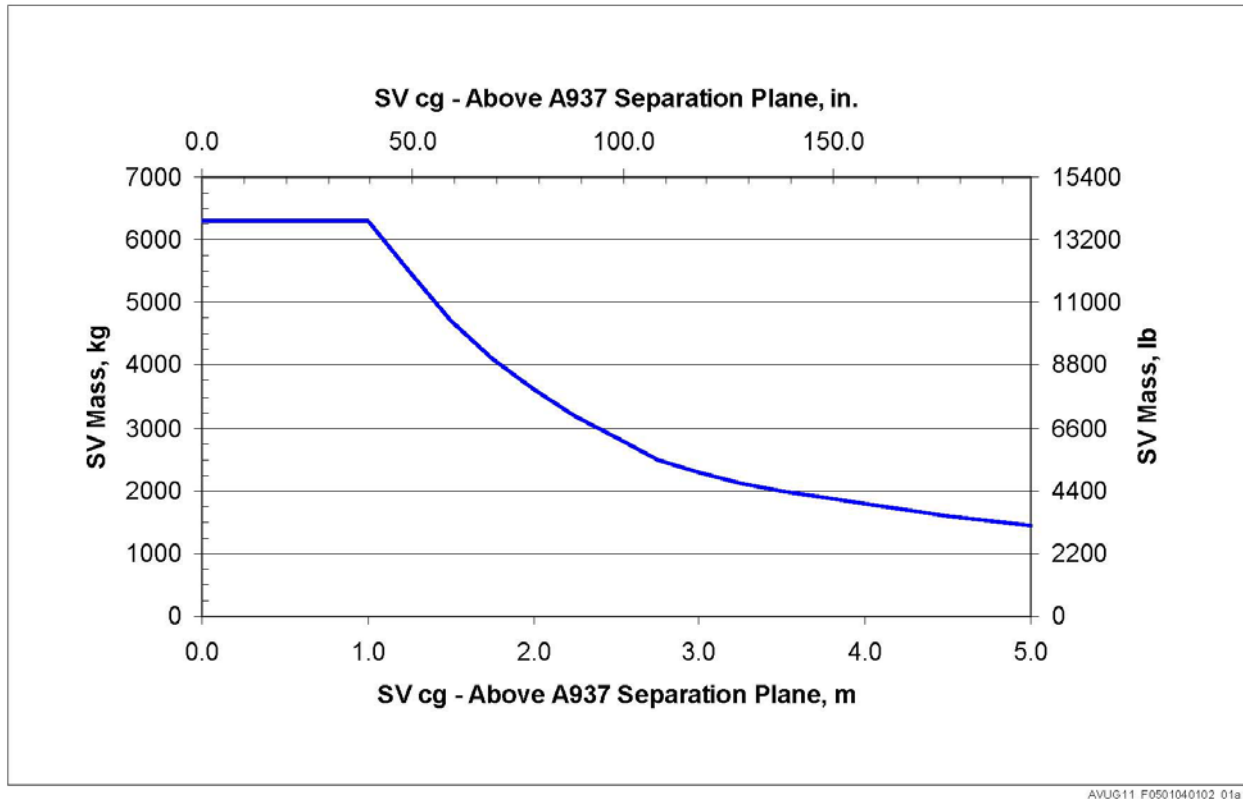
Expected allowable SC masses and longitudinal centers of gravity for the Type A937 payload adapter/separation systems are shown in Figure 5.1.4.2.2-1. These SC mass and center of gravity capabilities are determined using generic SC interface ring geometry as shown in Figure 5.1.4.2.3-1, and quasi-static load factors (see Section 3.2.1). Actual SC design allowables may vary depending on interface ring stiffness and results of SC mission-unique coupled loads analyses.



### 5.1.4.2.3 Payload Adapter Interfaces

The primary structural interface between the LV and SC occurs at the payload adapter forward ring. This ring interfaces with the SC aft ring. A payload separation system holds the two rings together for the structural joint and provides the release mechanism for SC separation. Electrical bonding is provided across all interface planes associated with these components. The payload adapter also provides mounting provisions for separation springs and supports interfacing components for electrical connectors between the LV and SC. Figures 5.1.4.2.3-1 and 5.1.4.2.3-2 show the interface requirements for these components. Additional mission-unique provisions, including SC purge provisions, SC range safety destruct units, and mission satisfaction kit instrumentation, may be added as necessary.

Figure 5.1.4.2.2-1: Atlas Type A937 Payload Adapter Structural Capability

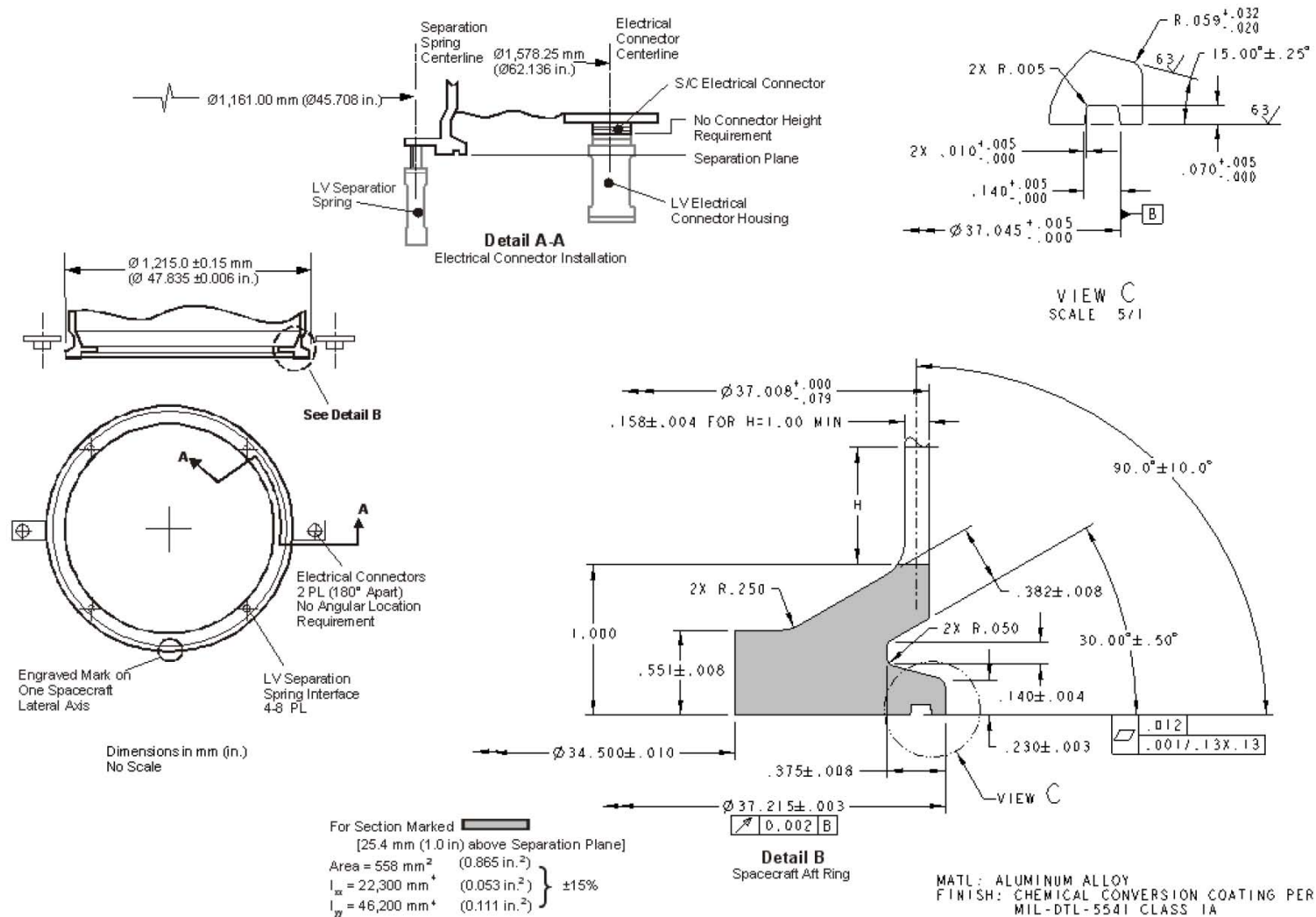


AVUG11\_F0501040102\_01a

### 5.1.4.2.4 Static Payload Envelope

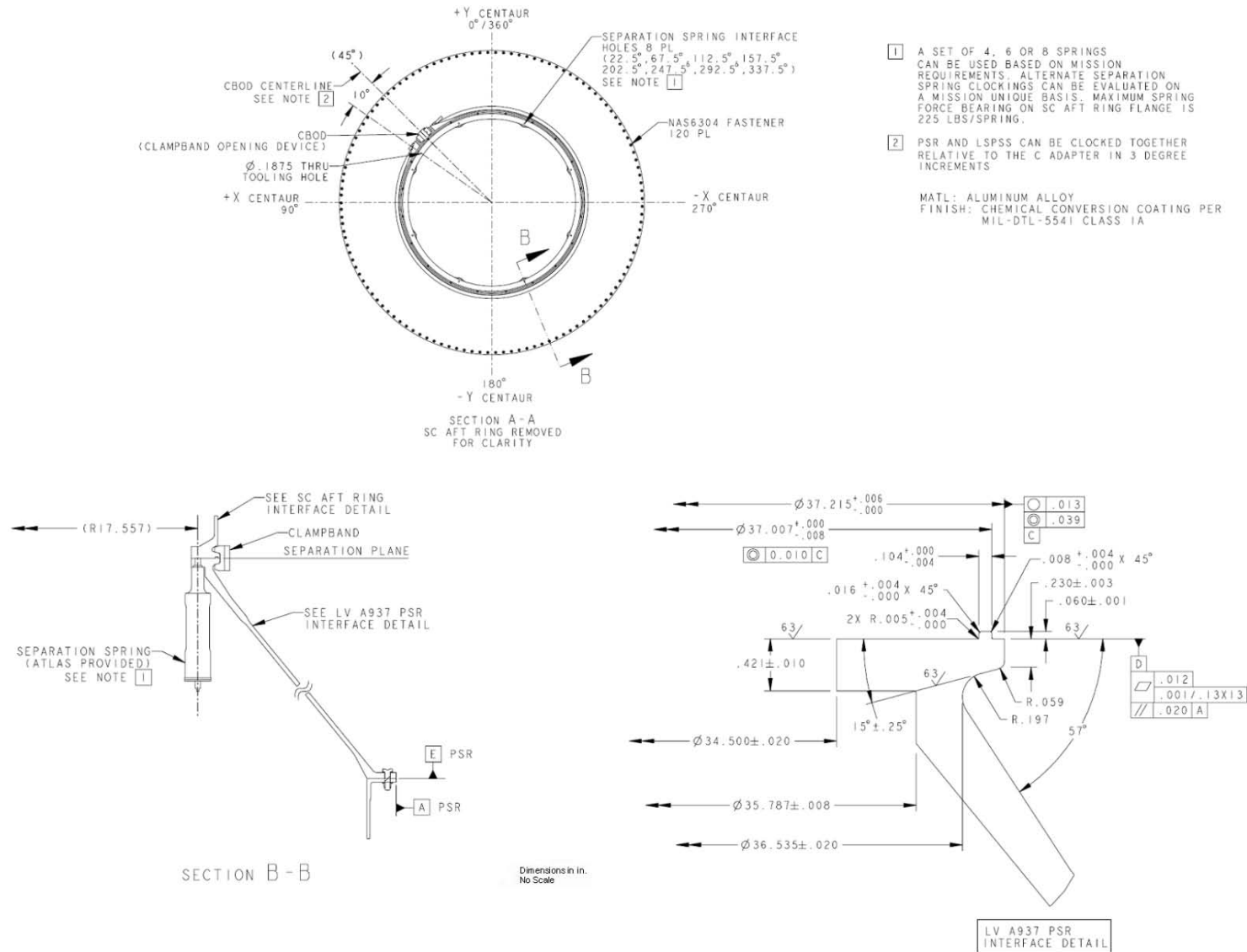
The static payload envelope defines the usable volume for the SC relative to the payload adapter. This envelope represents the maximum allowable SC static dimensions (including manufacturing tolerances) relative to the SC/payload adapter interface. This envelope design allows access to mating components and payload separation system for integration and installation operations, motion of the payload separation system during its operation, and the movement of the SC and LV after separation of the SC. Clearance layouts and separation analyses are performed for each SC configuration, and if necessary, critical clearance locations are measured during SC-to-payload-adapter mate operations to ensure positive clearance during flight and separation. Figure 5.1.4.2.4-1 shows the detailed views of the static payload envelope for the Atlas V Type A937 payload adapter.

Figure 5.1.4.2.3-1: Spacecraft Interface Requirements for Atlas V Type A937 PSR



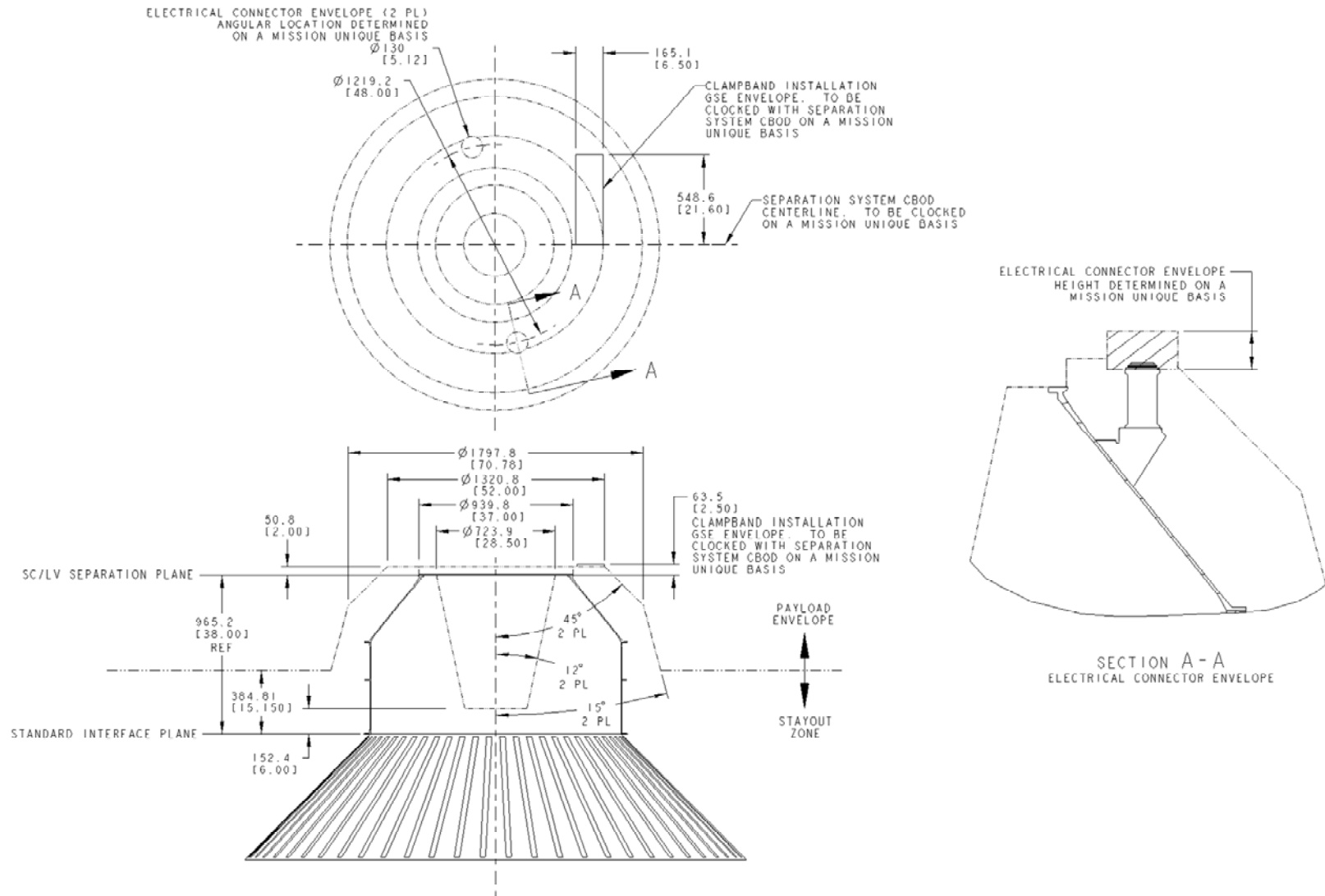
AVUG11\_F0501040103\_1a

Figure 5.1.4.2.3.-2: Atlas V Type A937 PSR Interface Requirements



AVUG11\_F0501040103\_02a

Figure 5.1.4.2.4-1: Atlas V Type A937 Payload Adapter Static Payload Envelope



AVUG11\_F0501040104\_01b

**5.1.4.3 Atlas V Type B1194 Payload Adapter**

The Atlas V Type B1194 payload adapter design supports the SC with an aft ring diameter of 1,194 mm (47 in.). Table 5.1.4.3-1 summarizes the major characteristics of this payload adapter.

The Type B1194 payload adapter (Figure 5.1.4.3-1) consists of two major sections: the payload separation ring (with separation system) and the LV adapter described in Section 5.1.3. The payload separation ring is a machined aluminum component in the form of a 254 mm (10-in.) high truncated cone. The forward ring has an outer diameter of 1,215 mm (47.835 in.) and forms the SC separation plane. The aft ring has an outer diameter of 1,596 mm (62.84 in.) and contains 120 evenly spaced bolt holes that allow it to be joined to the LV adapter. This symmetrical bolt hole pattern allows the payload separation ring and attached SC to be rotated relative to the LV in 3-degree increments to meet mission-unique requirements. The payload separation ring supports all hardware that directly interfaces with SC, including the payload separation system, electrical connectors, and mission-unique options.

**Table 5.1.4.3-1: Atlas V Type B1194 Payload Adapter Characteristics**

Atlas V Type B1194 Payload Adapter	
Construction	Two-Piece, Integrally Machined Aluminum Construction
Mass Properties	See Section 2.5.1
Payload Capability (Figure 5.1.4.2.2-1)	6,300 kg at 2.4 m (13,890 lbs at 94.5 in.)
P/L Sep System	LSPSS1194
Max Shock Levels	2,800 G (Section 3.2.4)
Clampband Preload — Installation	67.8 +0.5/ -0 kN (15,242 +112/-0 lb)
Clampband Preload — Flight	60.0 ± 0.5 kN (13,490 ± 112 lb)
Separation Springs	
Number	4, 6 or 8
Force per Spring — Max	1 kN (225 lb)

**5.1.4.3.1 Payload Separation System**

The Atlas Type B1194 payload adapter uses a LV-provided, Marmon-type clampband payload separation system as described in detail in Section 5.1.4.1.

**5.1.4.3.2 Payload Adapter Structural Capabilities**

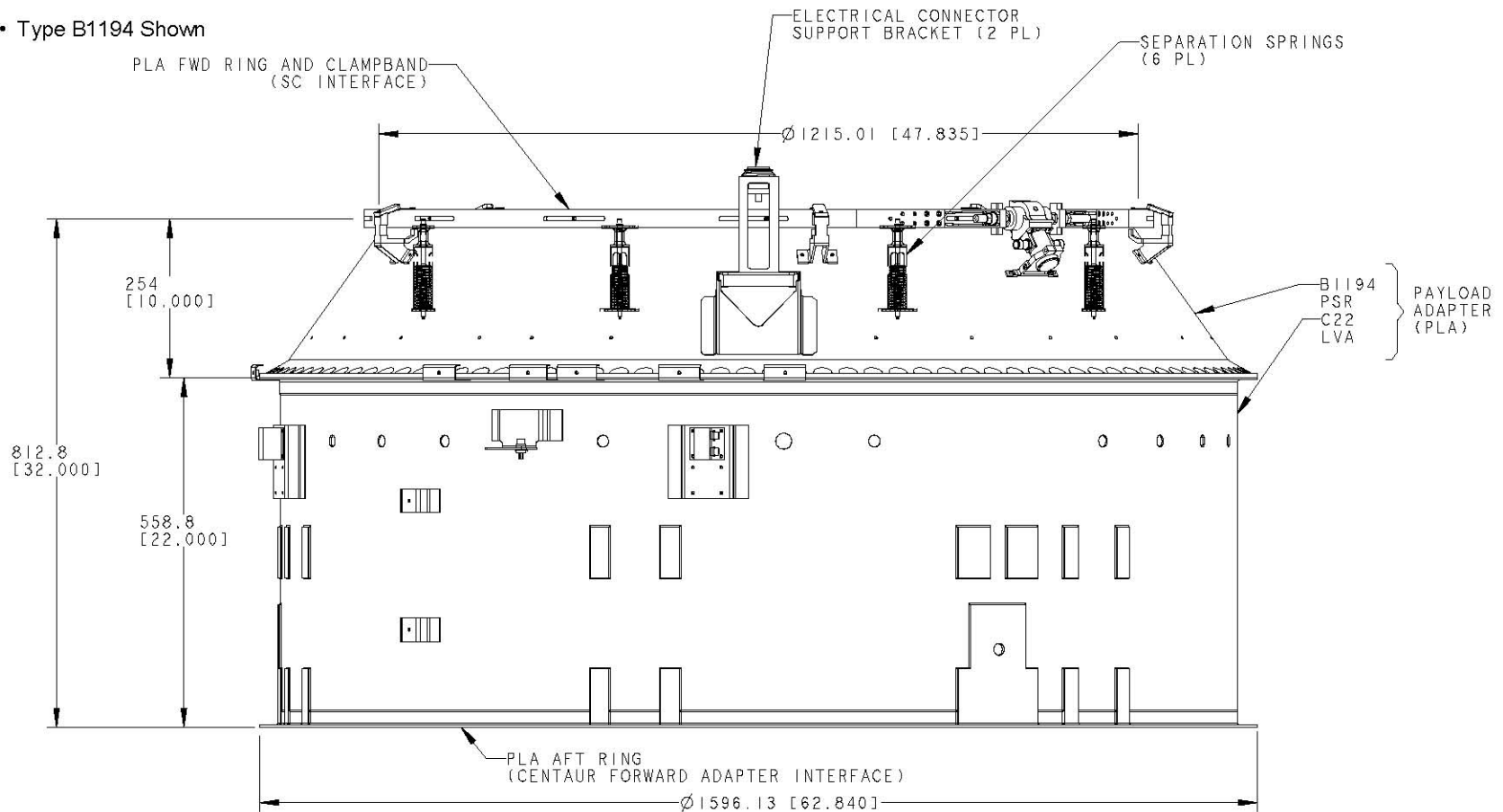
Figure 5.1.4.3.2-1 shows the allowable SC weights and longitudinal centers of gravity for the Type B1194 payload adapter/separation systems. These SC mass and center of gravity capabilities were determined using generic SC interface ring geometry shown in Figure 5.1.4.3.3-1, and quasi-static load factors (see Section 3.2.1). Actual SC design allowables may vary depending on interface ring stiffness and results of SC mission-unique coupled loads analyses. Additional structural testing may be performed to increase the capabilities defined in Figure 5.1.4.3.2-1. Coordination with the Atlas V program is required to define appropriate structural capabilities for SC designs that exceed these generic allowables.

**5.1.4.3.3 Payload Adapter Interfaces**

The primary structural interface between the LV and SC occurs at the payload adapter forward ring. This ring interfaces with the SC aft ring. A payload separation system holds the two rings together for the structural joint and provides the release mechanism for SC separation. Electrical bonding is provided across all interface planes associated with these components. The payload adapter also provides mounting provisions for separation springs and supports interfacing components for electrical connectors between the LV and SC. Figures 5.1.4.3.3-1 and 5.1.4.3.3-2 show the interface requirements for these components. Additional mission-unique provisions, including SC purge provisions, SC range safety destruct units, and mission satisfaction kit instrumentation, may be added as necessary.

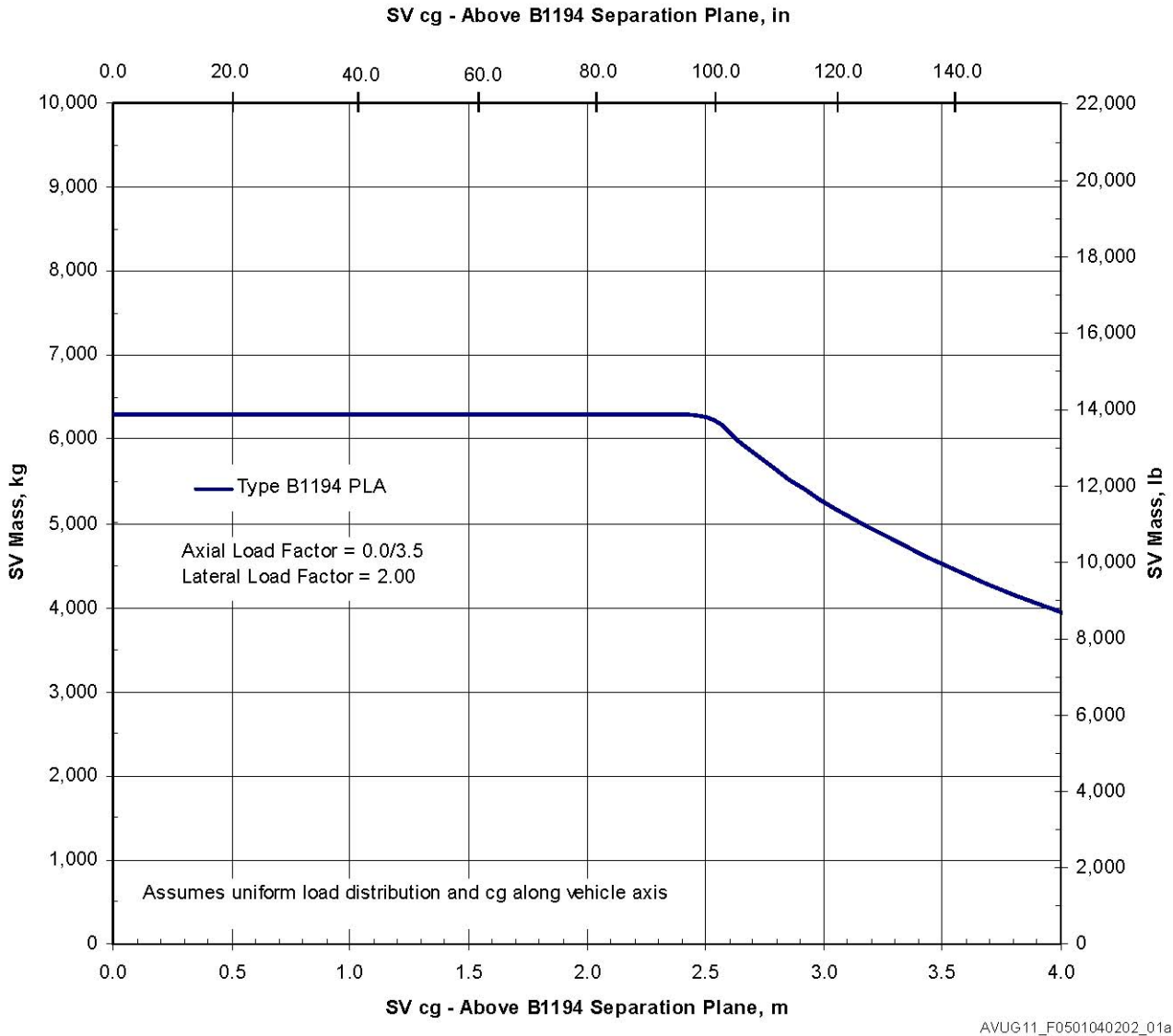
Figure 5.1.4.3-1: Atlas V Type B1194 Payload Adapter

• Type B1194 Shown



AVUG11\_F05010402\_01a

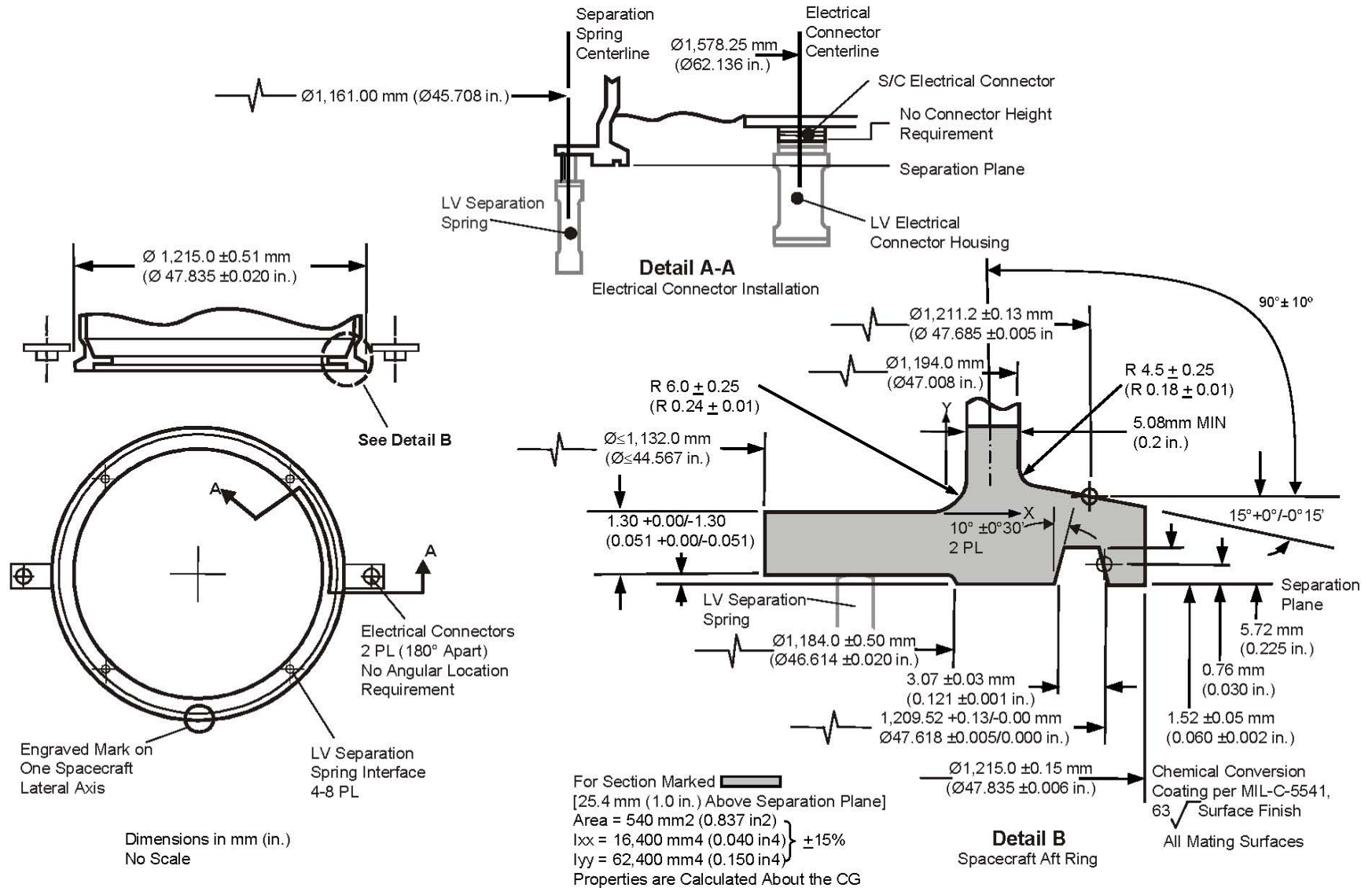
Figure 5.1.4.3.2-1: Atlas Type B1194 Payload Adapter Structural Capability



**5.1.4.3.4 Static Payload Envelope**

The static payload envelope defines the usable volume for the SC relative to the payload adapter. This envelope represents the maximum allowable SC static dimensions (including manufacturing tolerances) relative to the SC/payload adapter interface. This envelope design allows access to the mating components and payload separation system for integration and installation operations, motion of the payload separation system during its operation, and movement of the SC and LV after separation of the SC. Clearance layouts and separation analyses are performed for each SC configuration and, if necessary, critical clearance locations are measured during SC-to-payload-adapter mate operations to ensure positive clearance during flight and separation. Figure 5.1.4.3.4-1 shows detailed views of the static payload envelope for the B1194 payload adapter.

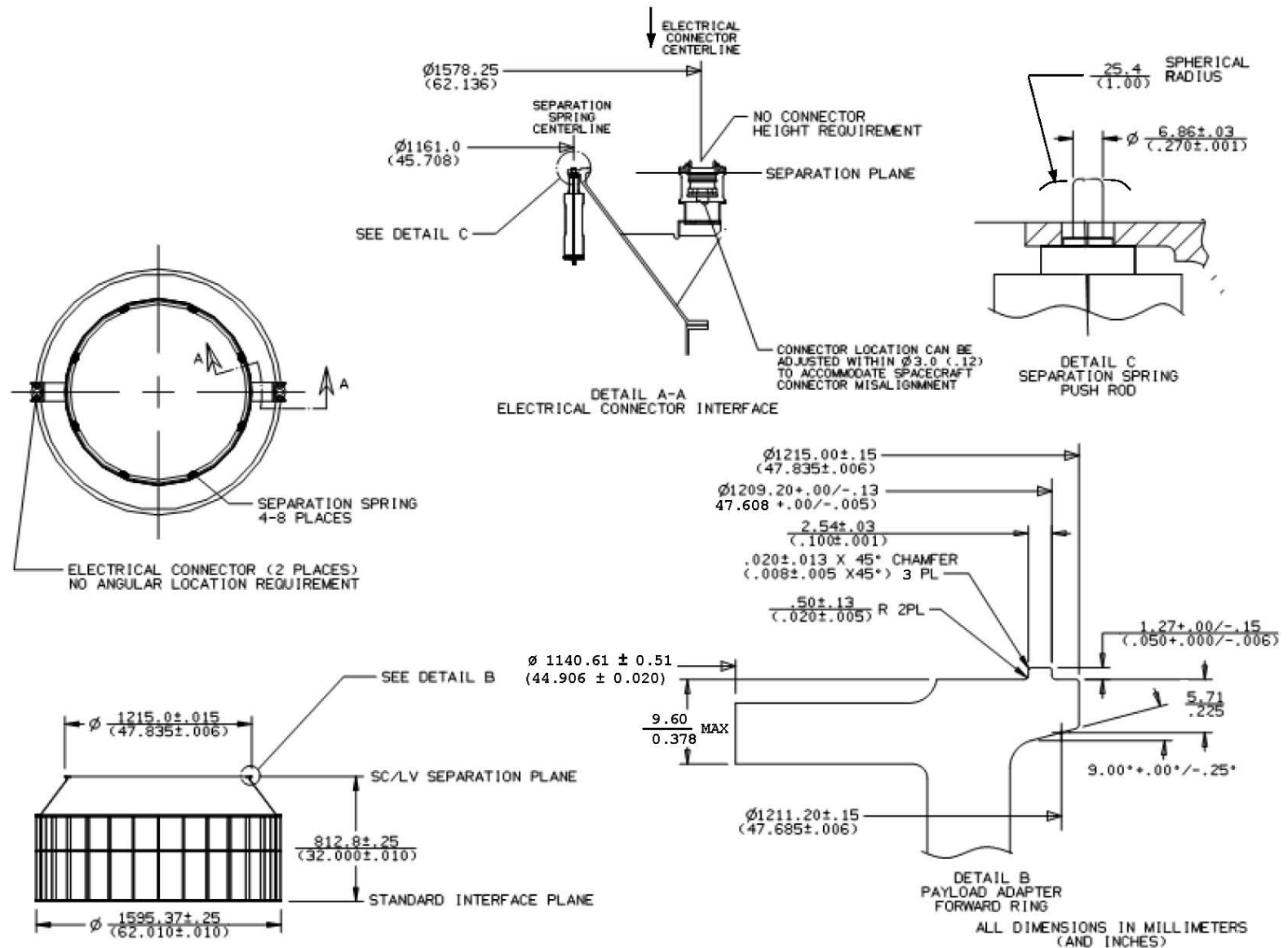
Figure 5.1.4.3.3-1: Spacecraft Interface Requirements for Atlas V Type B1194 PSR



AVUG11\_F0501040203\_01a

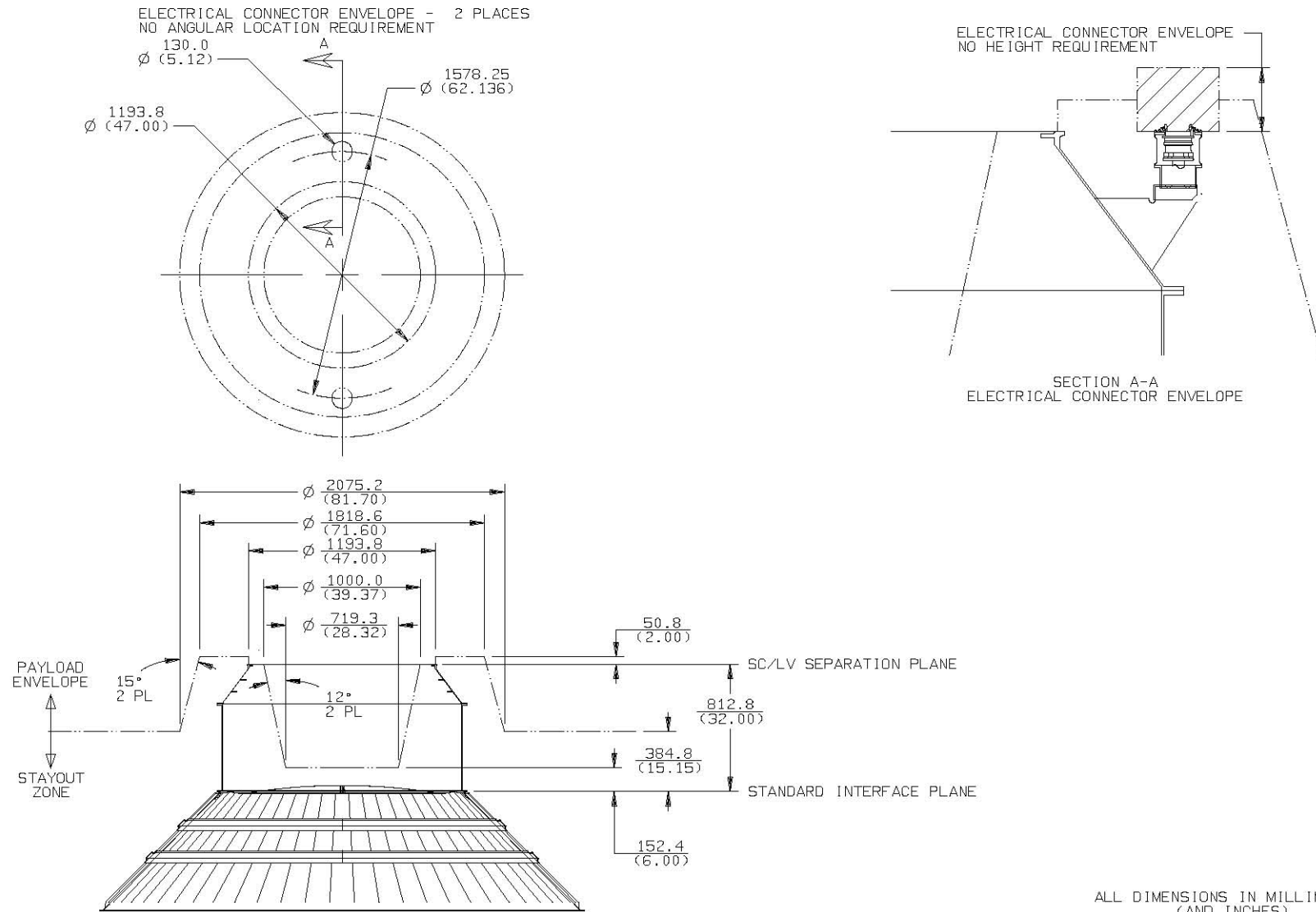


Figure 5.1.4.3.3-2: Atlas V Type B1194 PSR Interface Requirements



AVUG11\_F0501040203\_02a

Figure 5.1.4.3.4-1: Atlas V Type B1194 Payload Adapter Static Payload Envelope



ALL DIMENSIONS IN MILLIMETERS  
 (AND INCHES)

AVUG11\_F0501040204\_01a

**5.1.4.4 Atlas V Type D1666 Payload Adapter**

The Atlas V Type D1666 payload adapter design supports the SC with an aft ring diameter of 1,666 mm (66 in.). Table 5.1.4.4-1 summarizes major characteristics of this payload adapter.

The Type D1666 payload adapter (Figure 5.1.4.4-1) consists of two major sections: the payload separation ring (with separation system) and the LV adapter described in Section 5.1.3. The payload separation ring is a machined aluminum component in the form of a 330.2-mm (13-in.) high truncated cone. The forward ring has an outer diameter of 1,666.1 mm (65.594 in.) and forms the SC separation plane. The aft ring has an outer diameter of 1,596 mm (62.84 in.) and contains 120 evenly spaced holes that allow it to be joined to the LV adapter. This symmetrical hole pattern allows the payload separation ring and attached SC to be rotated relative to the LV in 3-degree increments to meet mission-unique requirements. The payload separation ring supports all hardware that directly interfaces with SC, including the payload separation system, electrical connectors, and mission-unique options.

**Table 5.1.4.4-1: Atlas V Type D1666 Payload Adapter Characteristics**

Atlas V Type D1666 Payload Adapter	
Construction	Two-Piece, Integrally Machined Aluminum
Mass Properties	See Section 2.5.1
Payload Capability (Figure 5.1.4.3.2-1)	6,000 kg at 2.0 m (13,225 lb at 78.8 in.)
P/L Sep System	LSPSS1666
Max Shock Levels	3,000 G (Section 3.2.4)
Clampband Preload — Installation	45.2 +0.5/-0 kN (10,160 +112/-0 lb)
Clampband Preload — Flight	40.0 ± 0.5 kN (8,990 ± 112 lb)
Separation Springs	
Number	4, 6 or 8
Force per Spring — Max	1 kN (225 lb)

**5.1.4.4.1 Payload Separation System**

The Atlas V Type D1666 payload adapter uses a LV-provided Marmon-type clampband payload separation system as described in detail in Section 5.1.4.1.

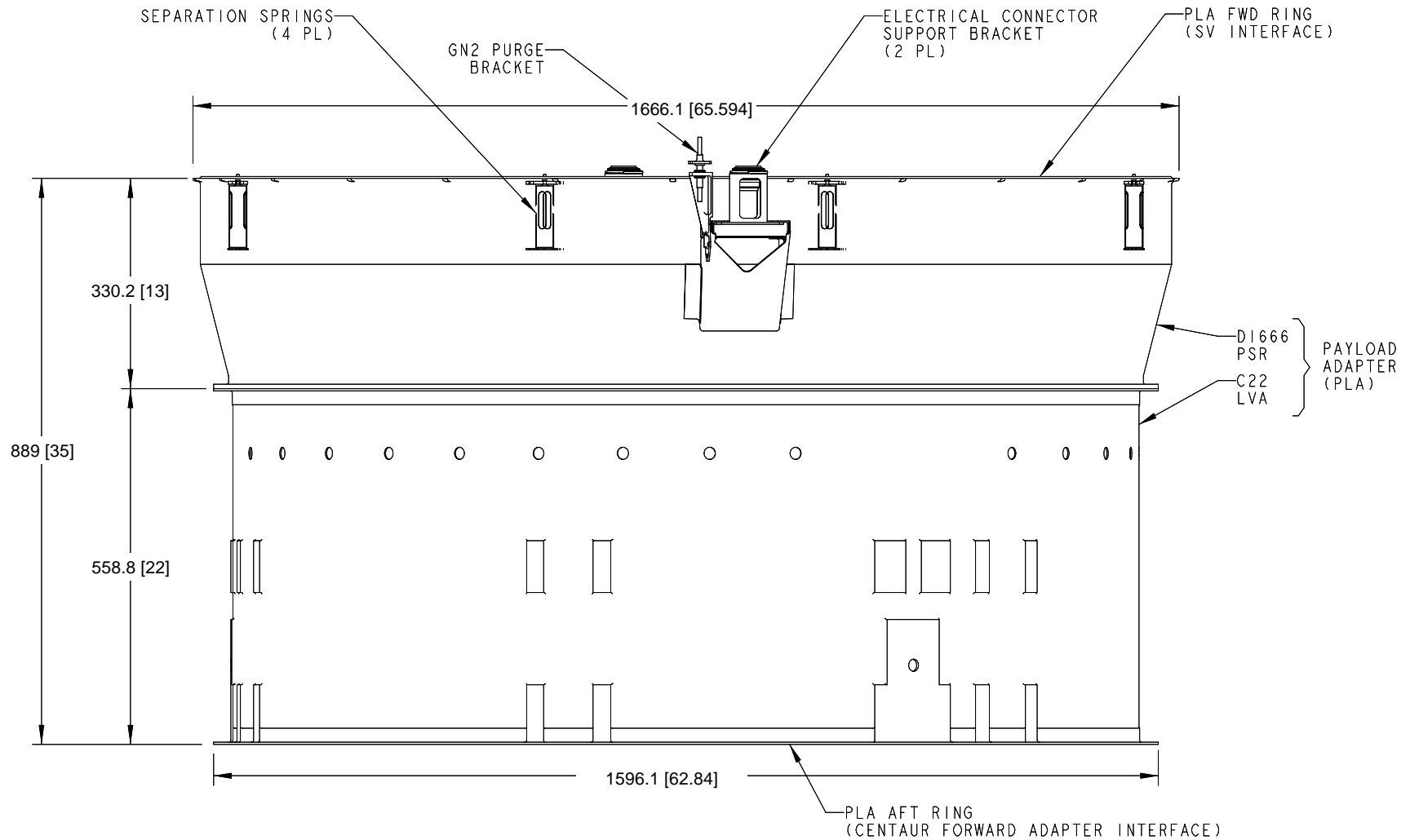
**5.1.4.4.2 Payload Adapter Structural Capabilities**

Figure 5.1.4.4.2-1 shows the allowable SC masses and longitudinal centers of gravity for the Type D1666 payload adapter/separation systems. These SC mass and center of gravity capabilities were determined using generic SC interface ring geometry shown in Figure 5.1.4.4.3-1, and quasi-static load factors (see Section 3.2.1). Actual SC design allowables may vary depending on interface ring stiffness and results of SC mission-unique coupled loads analyses. Coordination with the Atlas V program is required to define appropriate structural capabilities for SC designs that exceed these generic allowables.

**5.1.4.4.3 Payload Adapter Interfaces**

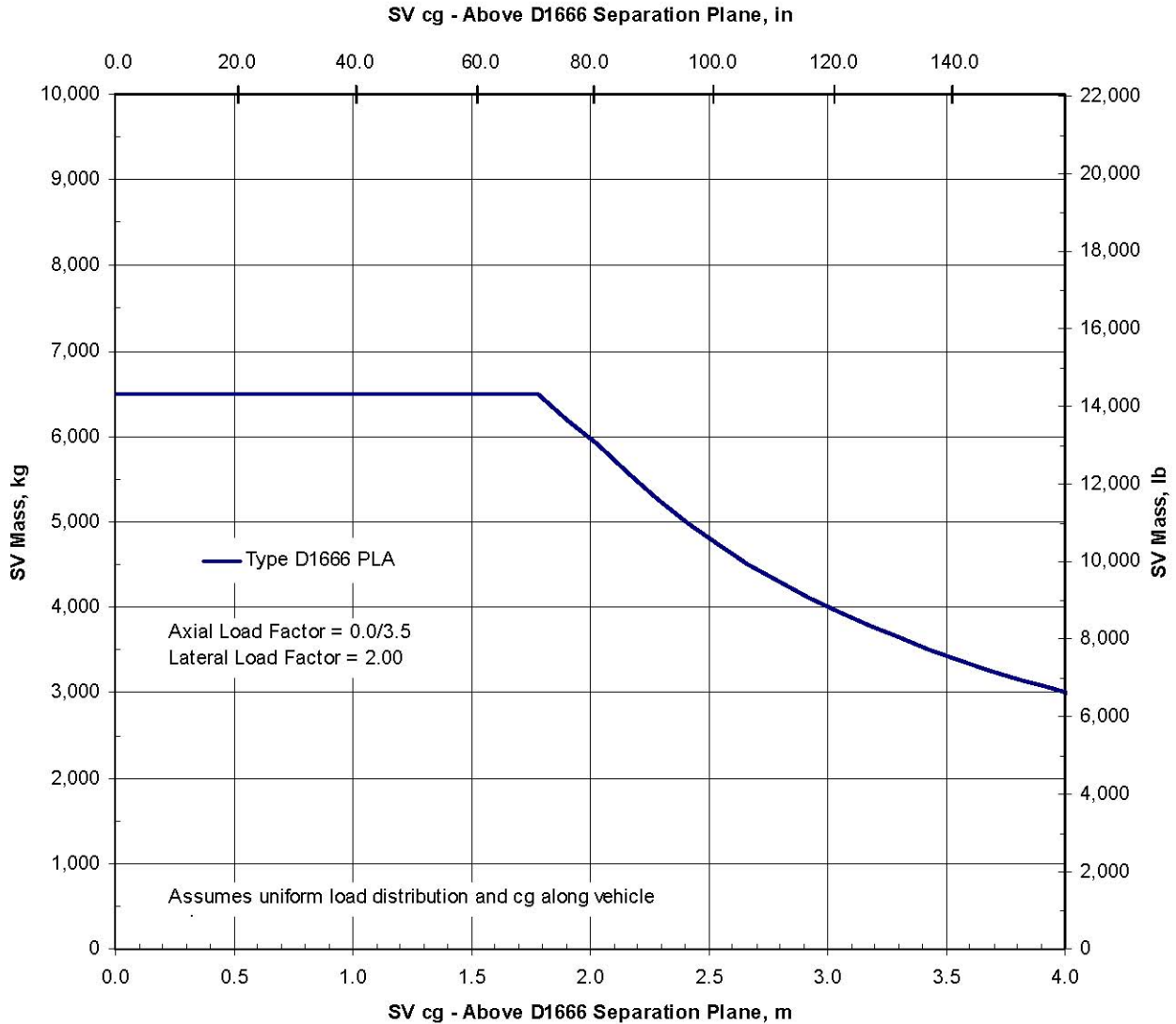
The primary structural interface between the LV and SC occurs at the payload adapter forward ring. This ring interfaces with the SC aft ring. A payload separation system holds the two rings together for the structural joint and provides the release mechanism for SC separation. Electrical bonding is provided across all interface planes associated with these components. Figures 5.1.4.4.3-1 and 5.1.4.4.3-2 show the interface requirements for these components. The payload adapter also provides mounting provisions for separation springs and supports interfacing components for electrical connectors between the LV and SC. Additional mission-unique provisions, including SC purge provisions, SC range safety destruct units, and mission satisfaction kit instrumentation, may be added as necessary.

Figure 5.1.4.4-1: Atlas V Type D1666 Payload Adapter



AVUG11\_F05010403\_01d

Figure 5.1.4.4.2-1: Atlas V Type D1666 Payload Adapter Structural Capability

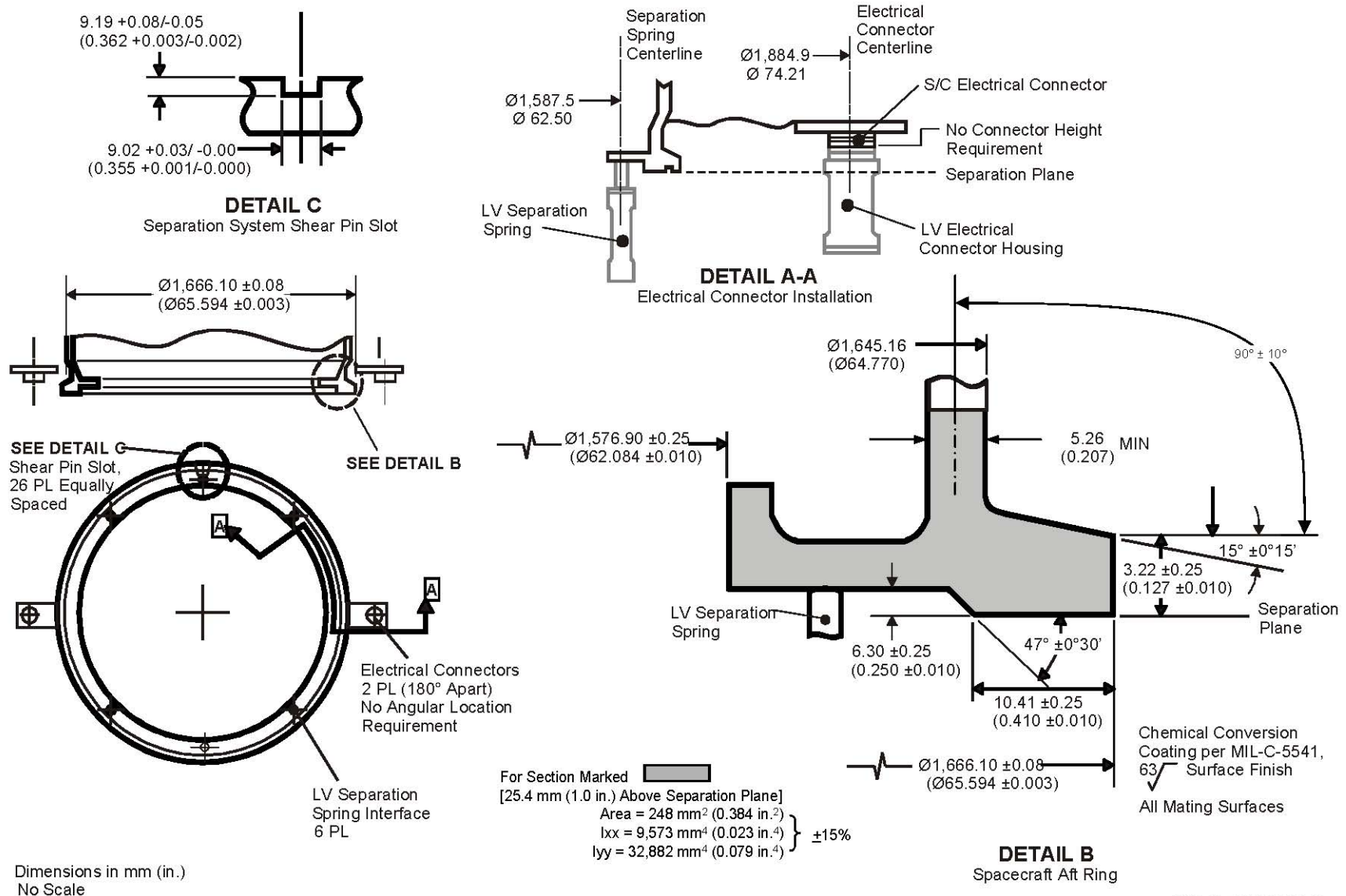


AVUG11\_F0501040302\_01a

5.1.4.4.4 Static Payload Envelope

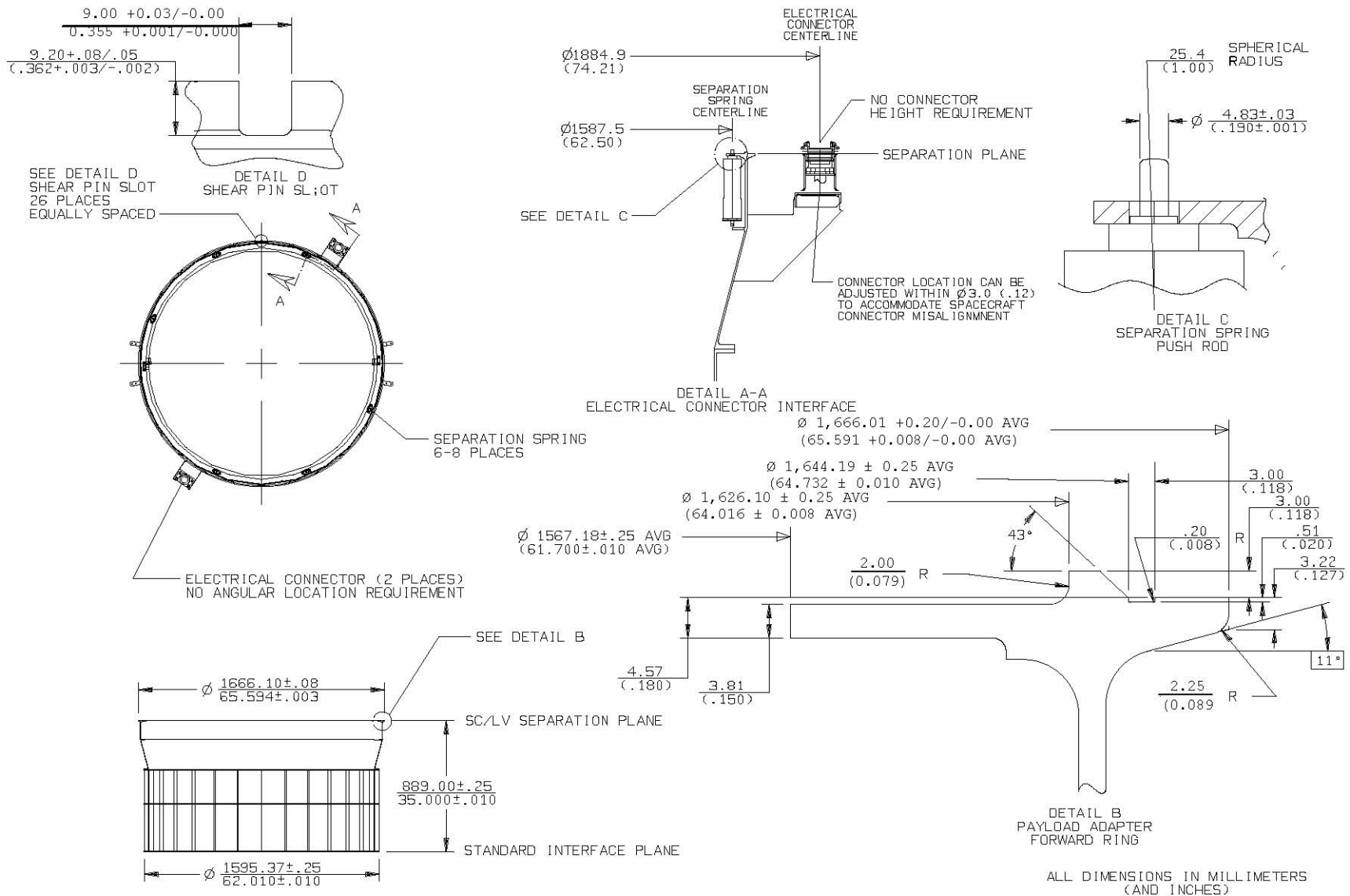
The static payload envelope defines the usable volume for the SC relative to the payload adapter. This envelope represents the maximum allowable SC static dimensions (including manufacturing tolerances) relative to the SC/payload adapter interface. This envelope design allows access to the mating components and payload separation system for integration and installation operations, motion of the payload separation system during its operation, and movement of the SC and LV after separation of the SC. Clearance layouts and separation analyses are performed for each SC configuration, and if necessary, critical clearance locations are measured during SC-to-payload-adapter mate operations to ensure positive clearance during flight and separation. Figure 5.1.4.4.4-1 shows detailed views of the static payload envelope for the D1666 payload adapter.

Figure 5.1.4.4.3-1: Spacecraft Interface Requirements for Atlas V Type D1666 PSR



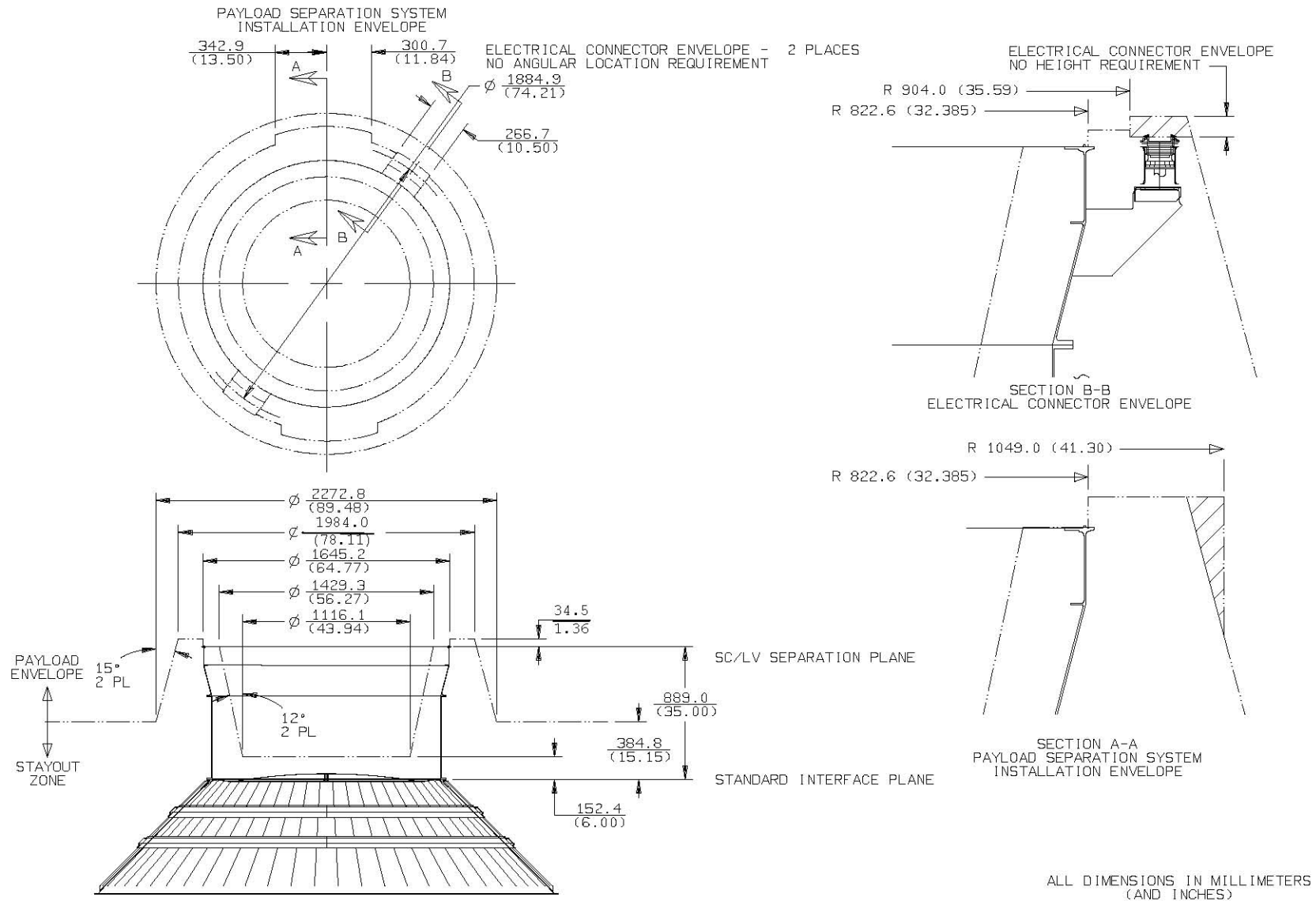
AVUG11\_F0501040303\_01a

Figure 5.1.4.4.3-2: Atlas V Type D1666 Payload Adapter Interface Requirements



AVUG11\_F0501040303\_02a

Figure 5.1.4.4.4-1: Atlas V Type D1666 Payload Adapter Static Payload Envelope



AVUG11\_F0501040304\_01a



#### 5.1.4.5 Atlas V Type F1663 Payload Adapter

The Atlas V Type F1663 adapter was developed to support a payload using a four-hard point interface on a diameter of 1,663 mm (65.50 in.). This payload adapter consists of two major sections: the payload separation ring (with separation system) and the LV adapter. The payload separation ring is a machined aluminum component in the form of approximately a 558.8-mm (22.00-in.) high truncated cone. The forward ring has four bearing surfaces that incorporate shear cones and bolt holes on an interface diameter of 1,663 mm (65.50 in.) that form the SC separation plane. The payload separation ring supports all hardware that directly interfaces with SC, including the payload separation system, electrical connectors, and mission-unique options.

The LV adapter is a machined aluminum component in the form of a monocoque cylinder. The aft ring has an outer diameter of 1,595 mm (62.81 in.) and contains 121 bolt holes that match up with Atlas V standard interface plane requirements. The nominal height of the LV adapter is 558.8 mm (22.00 in.), but this height may be varied from 330.2 mm (13.00 in.) to 736.6 mm (29.00 in.) to meet mission-unique requirements. The LV adapter includes all provisions for mating to the LV ground support equipment, including the torus arms and isolation diaphragm, used during ground processing operations.

Additional information about the Type F1663 payload adapter and SC interface requirements is available upon request.

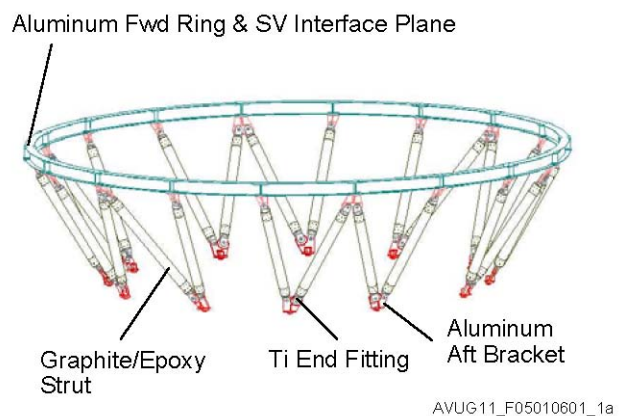
#### 5.1.5 Atlas V Truss Adapters

This section describes the two payload trusses that can be made available to support Atlas V 5-m payload fairing missions. ULA has yet to build, test, or qualify a flight-like truss as an assembly. However, an extensive design and qualification program was completed for individual struts. The struts were designed and manufactured from IM7/8552 fabric bonded to titanium end fittings. The struts were tested to failure in tension and compression. A statistically significant number of struts were tested, and the test data were used to calculate A-Basis and B-Basis allowables in both tension and compression in accordance with methods from MIL-HNDBK-17. This strut assembly design is available for any truss design with a forward ring interface between  $\varnothing$  3,302 mm (130 in) and up to  $\varnothing$  4,572 mm (180 in.). The basic strut design is identical to what was tested and qualified with the exception of a length change to accommodate the truss diameter and height. In fact, a number of truss designs have been completed for a variety of space vehicle request for proposals. The strut and truss design solutions are awaiting a mission to be identified.

##### 5.1.5.1 T4394 Truss Adapter

A payload truss with a forward SC interface of 4,394-mm (173-in.) diameter has been developed to meet future SC interface requirements. The 1,168-mm (46-in.) high truss attaches at 12 locations to the Centaur forward adapter. The forward ring of the payload truss has 18-equally spaced mounting points for the SC, but could be easily modified to accommodate alternate mounting configurations (Figure 5.1.5.1-1). The truss has 24 graphite-epoxy struts with titanium alloy end fittings, aluminum alloy forward and aft brackets, and an aluminum alloy forward ring. When this truss is used, the static payload envelope extends to the top surface of the payload support truss forward ring. This mission-unique truss adapter is being designed to carry a SC up to 6136 kg (13,500 lb). Please contact ULA for more information about the T4394 Truss Adapter.

Figure 5.1.5.1-1: T4394 Truss Adapter

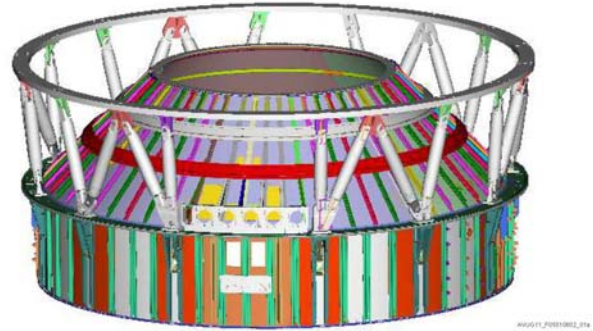


AVUG11\_F05010601\_1a

### 5.1.5.2 T3302 Truss Adapter

A payload truss with a forward SC interface of 3302-mm (130-in) diameter is under development to meet future SC interface requirements. The 914.4-mm (36-in) high truss attaches at 12 locations to the Centaur forward adapter. The forward ring of the payload truss has 14-equally spaced mounting points for the SC, but could be easily modified to accommodate alternate mounting configurations (Figure 5.1.5.2-1). The truss has 24 graphite-epoxy struts with titanium alloy end fittings, aluminum alloy forward and aft brackets, and an aluminum alloy forward ring. When this truss is used, the static payload envelope extends to the top surface of the payload support truss forward ring. This mission-unique truss adapter is being designed to carry SC weighing up to 20,400 kg (45,000 lb). Please contact ULA for more information about the T3302 Truss Adapter.

Figure 5.1.5.2-1: T3302 Truss Adapter



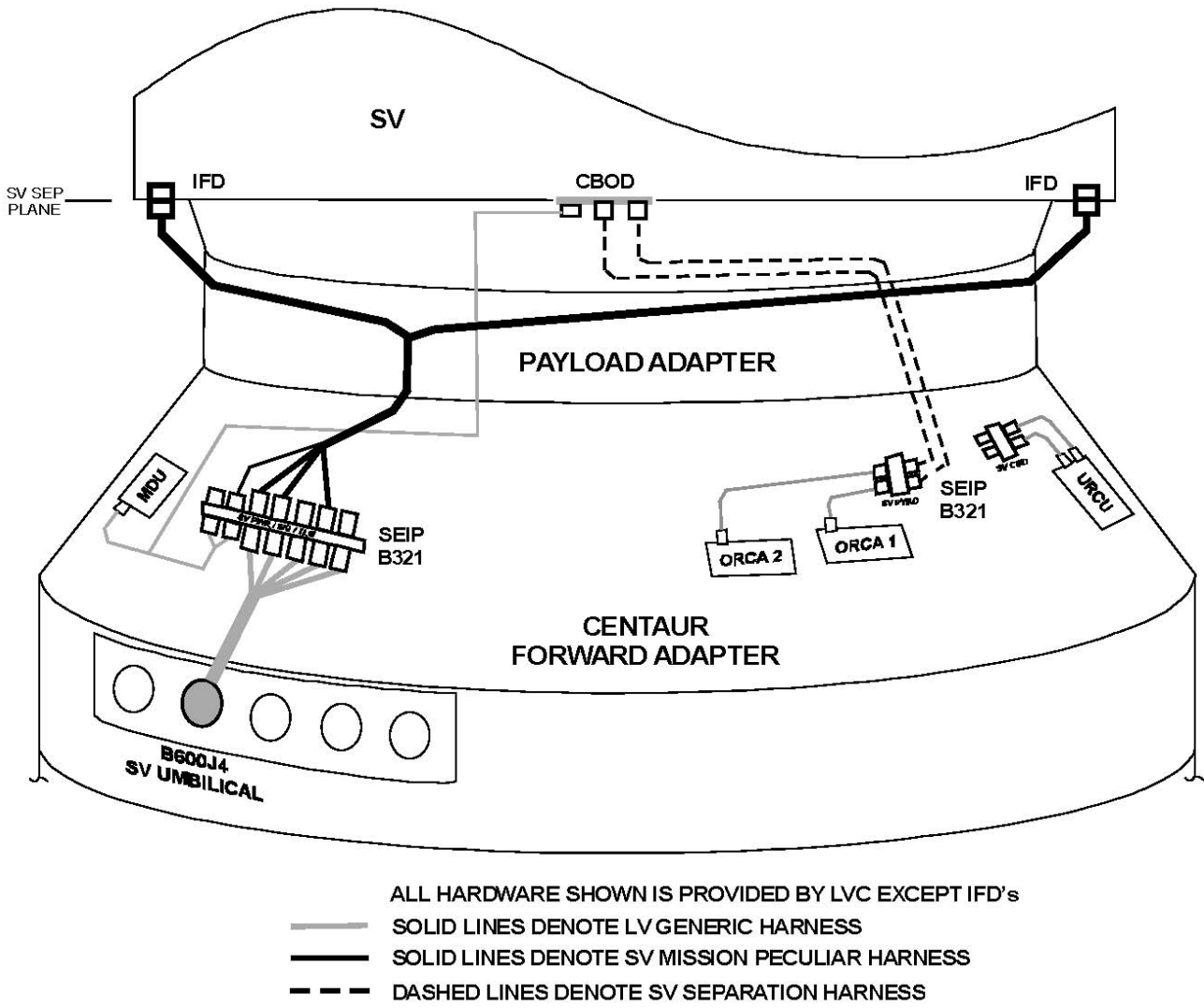
## 5.2 SPACECRAFT-TO-LAUNCH VEHICLE ELECTRICAL INTERFACES

SC and LV electrical interfaces are shown in Figures 5.2-1 and 5.2-2. Standard interfaces include:

1. A SC-dedicated umbilical interface between the umbilical disconnect located on the Centaur forward adapter and electrical In-Flight Disconnects (IFD) at the SC-to-LV interface;
2. SC and LV separation indicators (continuity loop wiring) located in the SC and LV IFDs to verify separation;
3. Standard IFDs or other customer supplied connectors that may be required by mission-unique requirements. For standard connectors, the following part numbers (or equivalent substitutes) apply:
  - a. 37 Contact      MS3446E37-50P (LV)    MS3464E37-50S (SC)
  - b. 61 Contact      MS3446E61-50P (LV)    MS3464E61-50S (SC)

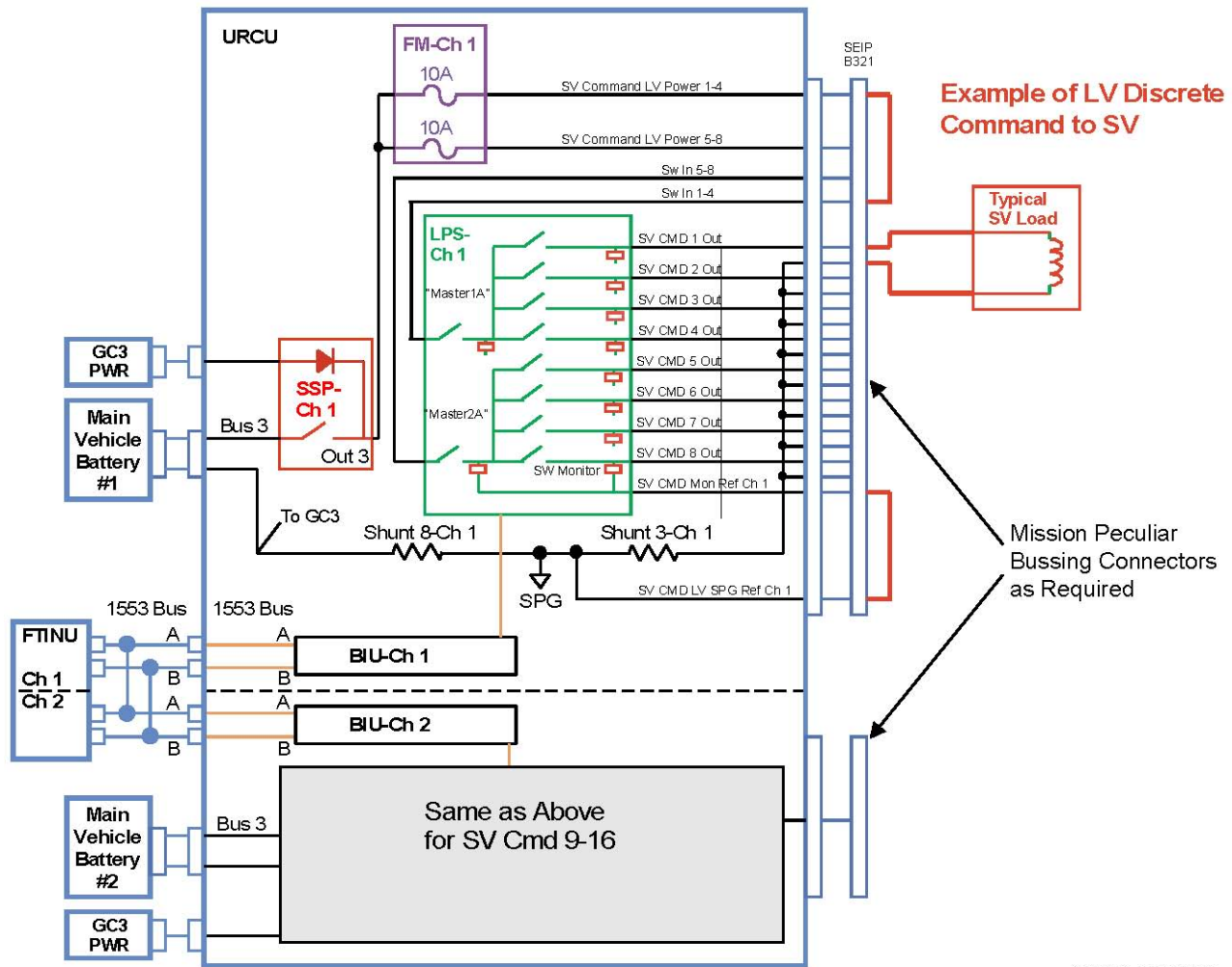
The Atlas V LV can also be configured to provide electrical interfaces for various mission-unique requirements. The following paragraphs describe the Atlas V electrical interfaces in detail.

Figure 5.2-1: Typical Spacecraft/Launch Vehicle Electrical Interface



AVUG-11\_F0502\_01a

Figure 5.2-2: Spacecraft Switch Interface Schematic



AVUG11\_F0502\_02a

### 5.2.1 Umbilical Spacecraft-to-Ground Support Equipment Interface

A SC dedicated umbilical disconnect for on-pad operations is located on the Centaur forward umbilical panel. This umbilical interface provides signal paths between the SC and Ground Support Equipment (GSE) for SC system monitoring during prelaunch and launch countdown operations. The umbilical disconnect separates at liftoff from the Centaur receptacle. The SC in-flight disconnect connectors disengage during separation of the SC from the Centaur. The complement of SC umbilical wires for the Atlas V vehicles for both launch sites are shown in Table 5.2.1-1.

#### 5.2.1.1 Electrical Ground Support Equipment Interface Electrical Constraints

To prevent potential damage to the LV ground and airborne systems in the event of a fault, the SC customer will be required to verify that the SC Electrical Ground Support Equipment (EGSE) interface design will provide current limiting protection in individual circuits for power, signals and data. Table 5.2.1-1 summarizes the current limits.

Increased current limits could be provided if significantly less than 41 wires are fully loaded. For example, if only the power circuits were loaded (24 wires), then the limit would be 27A vs 21 A. Any identified failed criteria will be addressed on a case by case basis. Mitigations such as procedural controls are acceptable.

Table 5.2.1-1: Payload Circuit Current Limits

Signal Type	Gauge (AWG)	Number of Circuits		Conductor Limit (A)	Multiple Wire Factor	Per Wire Limit (A)
		SLC 3E	SLC 41			
Power Circuit <sup>(1)</sup>	12	12 TP	12 TP	60	.35	21
Signal Triplet	20	4 TST	4 TST	15	.35	5
Signal Pair	20	58 TSP	60 TSP	15	.35	5
Data Circuit <sup>(2)</sup>	24	8 TSP 78Ω	6 TSP 78Ω	7.5	.35	2.5
Note: <sup>(1)</sup> If power-bussing provisions are required, other mission unique AWG of wire may be required <sup>(2)</sup> Limited by MLP wiring. <sup>(3)</sup> TP= twisted pair, TST= twisted shielded triples, TSP= twisted shielded pairs						

**5.2.2 Electrical In-Flight Disconnects**

Standard payload adapters provide two in-flight disconnect options of either 37 pins or 61 pins for the SC interface. These IFDs typically provide a SC-dedicated umbilical interface between the SC and GSE, and a capability for any LV command and monitoring required to support the SC during ascent. The Atlas V program can provide more IFDs on a mission-unique basis if the SC requires them.

**5.2.3 Spacecraft Separation System**

The baseline separation system for SC and Centaur separation is a pyrotechnic Marmon-type clampband system. The separation sequence is initiated by redundant commands from the Centaur guidance system. Positive indication of SC separation is detected by continuity loops installed in the SC IFDs that are wired to the Centaur instrumentation system. Indication of the separation event is telemetered to the ground.

**5.2.3.1 Separation Detection Circuits**

SC separation detection circuits across the LV electrical interface that initiate SC mission critical functions are required to be single fault tolerant. These SC circuits must be able to tolerate discontinuities up to 100 microseconds. Any identified failed criteria will be addressed on a case by case basis. The intent of this requirement is to ensure protection against inadvertent initiation of SC mission critical functions during LV ascent dynamic environments.

**5.2.4 Control Command Interface**

For the Atlas V LV, the Upper-stage Remote Control Unit (URCU) provides as many as 16 control commands (eight primary and eight secondary) to the SC as shown in Figure 5.2-2. The URCU channelization architecture allows each group of eight commands to be powered by an independent battery. In addition, there is a series inhibit ("master switch") per each group of four command switches that provide protection against a single "stuck ON" switch failure issuing a premature command. Each group of eight commands, along with two master switches, can be independently configured as a 28 Vdc (nominal) discrete from the LV, or as a switch closure function (using SC-provided power) depending on SC requirements. One of the two command types, discrete or closure, must be selected within a channel, however, each channel can be configured independently. Only one voltage can be applied to each group/channel (e.g. 28 Vdc from the LV to the SC is fed to all eight switches, independent voltage to each switch cannot be accommodated).

Command feedback provisions ensure that control commands issued to the SC are received through SC and LV IFDs. For SC mission critical functions, the SC is responsible for providing a feedback loop on the SC side of the interface, including fault isolation circuits.

The following are the standard electrical switching capabilities:

1. The maximum allowable current through each master switch is 8 amps.

2. Each individual command switch is rated at 4 amps maximum; however, the total current from four simultaneous ON commands cannot exceed the rating of the corresponding master switch.
3. The allowable voltage range which can be switched is 22-33 Vdc.
4. The system has been optimized for LV-discrete commands at 0.5 amps each or for switch closure commands at 1.0 amps each. Other mission unique requirements can be accommodated.
5. Commands can be controlled in 20 msec timing increments, individually or simultaneously per mission requirements. Mission unique implementations will accommodate Atlas V redundancy management requirements to ensure command sequences exceed 80 msec in duration. Such sequences will accommodate the maximum command dropout duration in the unlikely event of an FTINU switch-over.

Mission-unique compatibility analyses are performed for any interfaces that use these commands to verify proper circuit interaction and appropriate circuit electrical deratings.

### **5.2.5 Spacecraft Environment Instrumentation**

The Atlas V program offers a suite of instrumentation options to capture SC environments.

#### **5.2.5.1 Spacecraft Telemetry Interface**

The LV provides a mission satisfaction telemetry kit as an option to ascertain certain vehicle environments and ensure ICD requirements are met. Low frequency data (less than 200 Hz) can be captured through the LV Data Acquisition System (DAS) located on the Centaur. The Digital Telepak and Telemetry and Data Relay Satellite System (TDRSS) transmitter combination can provide up to 32 channels of wideband data (up to 8-kHz data) with a Pulse-Code Modulation (PCM) (Quadrature Phase-Shift Keying [QPSK]) telemetry format. Additional instrumentation may be added optionally up to the bandwidth and interface capabilities of these data systems. Data recorded from these measurements are provided post launch to evaluate compliance with ICD environmental requirements.

The available mission satisfaction instrumentation consists of (1) two acoustic measurements located inside the PLF, (2) three acceleration measurements at the SC-to-LV separation plane spaced 120 degrees apart, (3) three orthogonal vibration measurements at the SC-to-LV separation plane, (4) three orthogonal shock measurements at the SC-to-LV separation plane, (5) one absolute pressure measurement located in the SC compartment, and (6) one temperature measurement located in the SC compartment.

#### **5.2.5.2 Spacecraft Telemetry Options**

The Atlas V program offers two options for transmission of SC data.

##### **5.2.5.2.1 Radio Frequency Reradiation GSE Interface**

A modification of the Atlas V PLF is made to accommodate an RF reradiating antenna system to reradiate SC radio frequency (RF) telemetry and command signals from inside the PLF to a GSE site before launch. It must be noted that radiating RF inside an enclosed fairing will produce an enhanced resonant environment that may be in excess of SC or LV limits. Early in the integration process, ULA will perform an EMC analysis to evaluate this condition.

##### **5.2.5.2.2 Spacecraft Serial Data Interface**

The Atlas V LV can provide transmission of two SC serial data interfaces. SC data are interleaved with LV DAS data and serially transmitted in the PCM bit stream. For each data interface, the SC provides Nonreturn-to-Zero Level (NRZ-L) coded data and a clock from dedicated drivers (as an input to the LV). SC data and clock signals must be compliant with Electronics Industry Association RS-422, Electrical Characteristics of Balanced Voltage Digital Interface Circuits, with a maximum data bit rate of 2 kbps. SC

data are sampled by the LV on the leading edge of the SC clock signal. The clock-to-data skew must be less than 50 microseconds and the signal and clock duty cycles must be 50%  $\pm$ 5%. Cabling from the signal driver to the LV has a nominal characteristic impedance of 78 ohms. Data are presented as the original NRZ-L data stream in real time for those portions of prelaunch operations and flight for which Atlas V data are received. For postflight analysis, SC data can be recorded to digital media.

### 5.2.6 Spacecraft Destruct Option

If required for Range Safety considerations, Atlas V can provide a SC destruct capability. The Atlas V Flight Termination Subsystem (FTS) provides the capability to destruct the LV and payload if required during non-nominal performance either by a secure radio link, autonomously after detecting an inadvertent vehicle break-up, or unintentional separation of LV stages.

## 5.3 SPACECRAFT-TO-GROUND EQUIPMENT INTERFACES

### 5.3.1 Spacecraft Console

Floor space is allocated on the operations level of the launch control facility (the Launch Service Building at SLC-3E, and the payload van at LC-41) for installation of a SC ground control console(s). This console(s) is provided by the user, and interfaces with ULA-provided control circuits through the dedicated umbilical to the SC. Control circuits provided for SC use are isolated physically and electrically from those of the LV to minimize Electromagnetic Interference (EMI) effects. SC that require a safe and arm function for apogee motors will also interface with the range operated pad safety console. The Atlas V program will provide cabling between the SC console and the pad safety console. The safe and arm command function for the SC apogee motor must be inhibited by a switch contact in the pad safety console. Pad Safety will close this switch when it is safe to arm the system.

### 5.3.2 Power

Several types of electrical power are available at the launch complex for SC use. Commercial Alternating Current (AC) power is used for basic facility operation. Critical functions are connected to an Uninterruptible Power System (UPS). The dual UPS consists of battery chargers, batteries, and a static inverter. UPS power is available for SC use in the launch service building, umbilical tower, and payload van. Twenty-eight Vdc power can be provided for SC use in the launch service building. Facility power supplies are operated on the UPS to provide reliable service.

### 5.3.3 Liquids and Gases

All chemicals used will be in compliance with requirements restricting ozone-depleting chemicals.

**Gaseous Nitrogen (GN<sub>2</sub>)** — At SLC-41 three pressure levels of GN<sub>2</sub> are available on the service tower or Vertical Integration Facility (VIF) for SC use. Nominal pressure settings are 13,790 kN/m<sup>2</sup> (2,000 psi), 689.5 kN/m<sup>2</sup> (100 psi), and approximately 68.95 kN/m<sup>2</sup> (10 psi). The 10-psi system is used for purging electrical cabinets for safety and humidity control.

At VAFB, GN<sub>2</sub> is provided to payload pneumatic panels at SLC-3E. GN<sub>2</sub> is provided at 689.5 kN/m<sup>2</sup> (100 psig); 2,758 kN/m<sup>2</sup> (400 psig); 24,822 kN/m<sup>2</sup> (3,600 psig); and 34,475 kN/m<sup>2</sup> (5,000 psig).

**Gaseous Helium (GHe)** — Gaseous helium is available on service towers at both Cape Canaveral Air Force Station (CCAFS) and Vandenberg Air Force Base (VAFB). At CCAFS, GHe at 15,169 kN/m<sup>2</sup> (2,200 psi) is available. At VAFB SLC-3E, GHe at 589.5 kN/m<sup>2</sup> (100 psig) and 34,475 kN/m<sup>2</sup> (5,000 psig) is available.

**Liquid Nitrogen (LN<sub>2</sub>)** — LN<sub>2</sub> is available at the CCAFS launch complex storage facility. LN<sub>2</sub> is used primarily by the Atlas V pneumatic and LN<sub>2</sub> cooling systems. Small dewars can be filled at Range facilities and brought to the Atlas V launch complex for SC use.

**Gaseous Xenon (Xe)** — Gaseous xenon is available for use at CCAFS and VAFB. At both locations, xenon can be provided at various pressures and quantities subject to the user's specific requirements.

### 5.3.4 Propellant and Gas Sampling

Liquids and gases provided for SC use will be sampled and analyzed by the Range propellant analysis laboratory. Gases (e.g., helium, nitrogen, xenon, and breathing air) and liquids (e.g., hypergolic fuels and oxidizers), water, solvents, and hypergolic decontamination fluids may be analyzed to verify that they conform to the required specification.

### 5.3.5 Work Platforms

The launch complex service tower provides work decks approximately 3.048 m (10 ft) apart in the SC area. Portable workstands will be provided to meet SC mission requirements where fixed work decks do not suffice. Access can be provided inside the encapsulated nose fairing. Access requirements will be developed during the planning stage of each mission.

## 5.4 ATLAS V IN-FLIGHT VIDEO OPTION

Atlas V has the mission-unique capability to provide a non-standard launch service option of flight proven, in-flight video during the Atlas V LV mission. The Atlas V LV can be custom outfitted with up to two real-time National Television System Committee (NTSC) video links on the Centaur upper stage for pre-flight and in-flight video and one real time NTSC video link on the Atlas boosters. The two video streams on the Centaur can be configured from video inputs from up to two of three standard camera locations with a user-defined camera switching sequence. The Atlas booster video link can be configured from up to two standard video locations. If both cameras are selected on the Atlas booster they must be switched into the video transmitter. Only one camera can be powered on at any given time. ULA has installed video cameras on previous missions for viewing LV ascent, LV staging events, payload fairing separation and SC separation events. ULA provides the in-flight video to the customer in real-time viewing mode and high-quality recordings generated from supporting ground stations for post-flight use.

Table 5.4-1 lists the Atlas V's custom outfitted with in-flight video. Figures 5.4-1 and 5.4-2 show examples of in-flight video images taken during ascent.

**Table 5.4-1: Atlas Launch Vehicle In-Flight Video Missions**

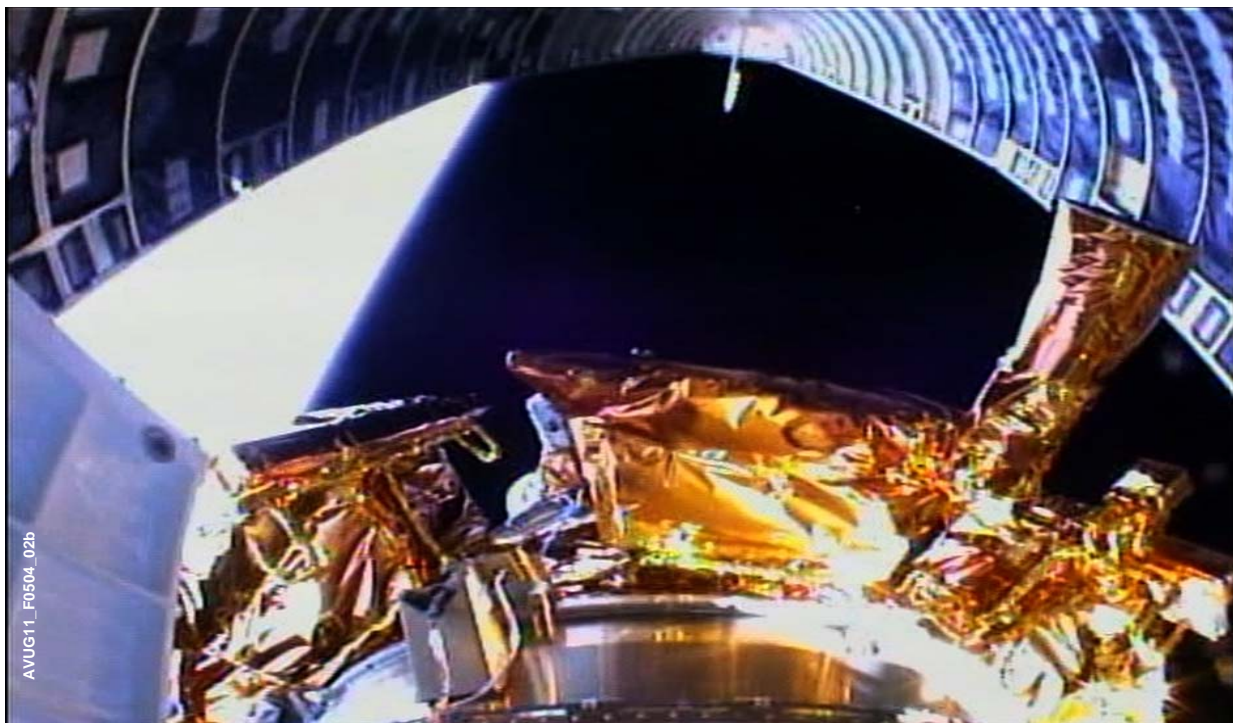
Mission	Atlas Vehicle	Spacecraft	Launch Site	Date
AC-201	Atlas IIIA — First Flight from CCAFS	Eutelsat-W4	CCAFS	May 24, 2001
AC-160	Atlas IIAS	MLV-10	VAFB	September 8, 2001
AV-001	Atlas V 401 — First Flight from CCAFS	Hotbird-6	CCAFS	August 21, 2002
AV-003	Atlas V 521 — First Flight from CCAFS	Rainbow 1	CCAFS	July 17, 2003
AC-164	Atlas IIAS	MLV-14	VAFB	December 2, 2003
AV-004	Atlas V 431 — First Flight with 3 SRBs	Inmarsat 4F1	CCAFS	March 11, 2005
AC-206	Atlas III	MLV-15	CCAFS	February 3, 2005
AV-010	Atlas V 551 — First 551, First Block II Avionics, First Block B SRBs	Pluto New Horizons	CCAFS	January 19, 2006
AV-020	Atlas V 401 — First IPC	LRO/LCROSS	CCAFS	June 18, 2009



Figure 5.4-1: Atlas Launch Vehicle In-Flight Video Image — Solid Rocket Booster Separation



Figure 5.4-2: Atlas Launch Vehicle In-Flight Video Image — Payload Fairing Separation



Intentionally Left Blank

## 6. PAYLOAD FAIRINGS

The Payload Fairing (PLF) encloses and protects the spacecraft during ground operations and launch vehicle ascent. The PLF incorporates hardware to control thermal, acoustic, electromagnetic, and cleanliness environments for the spacecraft. The PLF has standard access door locations and may also be tailored to provide additional spacecraft access and Radio Frequency (RF) communications to the encapsulated spacecraft. The Atlas V customer has a choice between the 4-meter (m) diameter (400 series) and 5-meter diameter (500 series) PLF configurations as shown in Figure 6-1. Both the 4-m and 5-m payload fairings are available in different lengths to meet spacecraft mission requirements as shown in Figure 6-2. Should a customer have a unique requirement to accommodate a larger payload, longer and wider payload fairings can be developed. Payload fairings as large as 7.2m (283 in.) in diameter and up to 32.3m (106 ft) in length have been considered. These larger fairings require moderate vehicle changes and modifications to the launch pad, which are limited mostly to secondary vertical processing facility structure. Please contact ULA for additional information on larger fairings.

Figure 6-1: Atlas V Payload Fairings



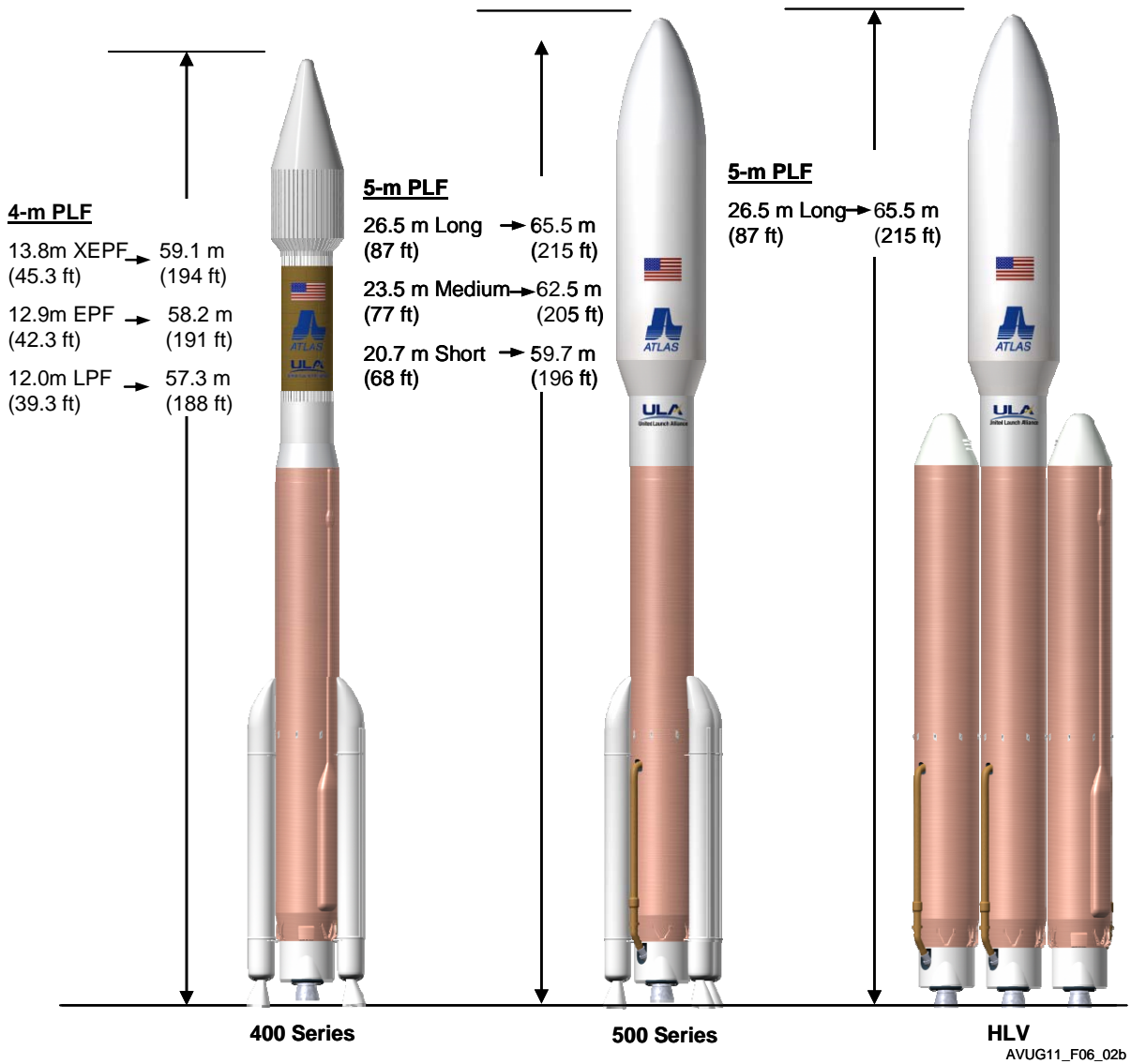
Atlas V 4-m PLF



Atlas V 5-m PLF

AVUG11\_F06\_01a

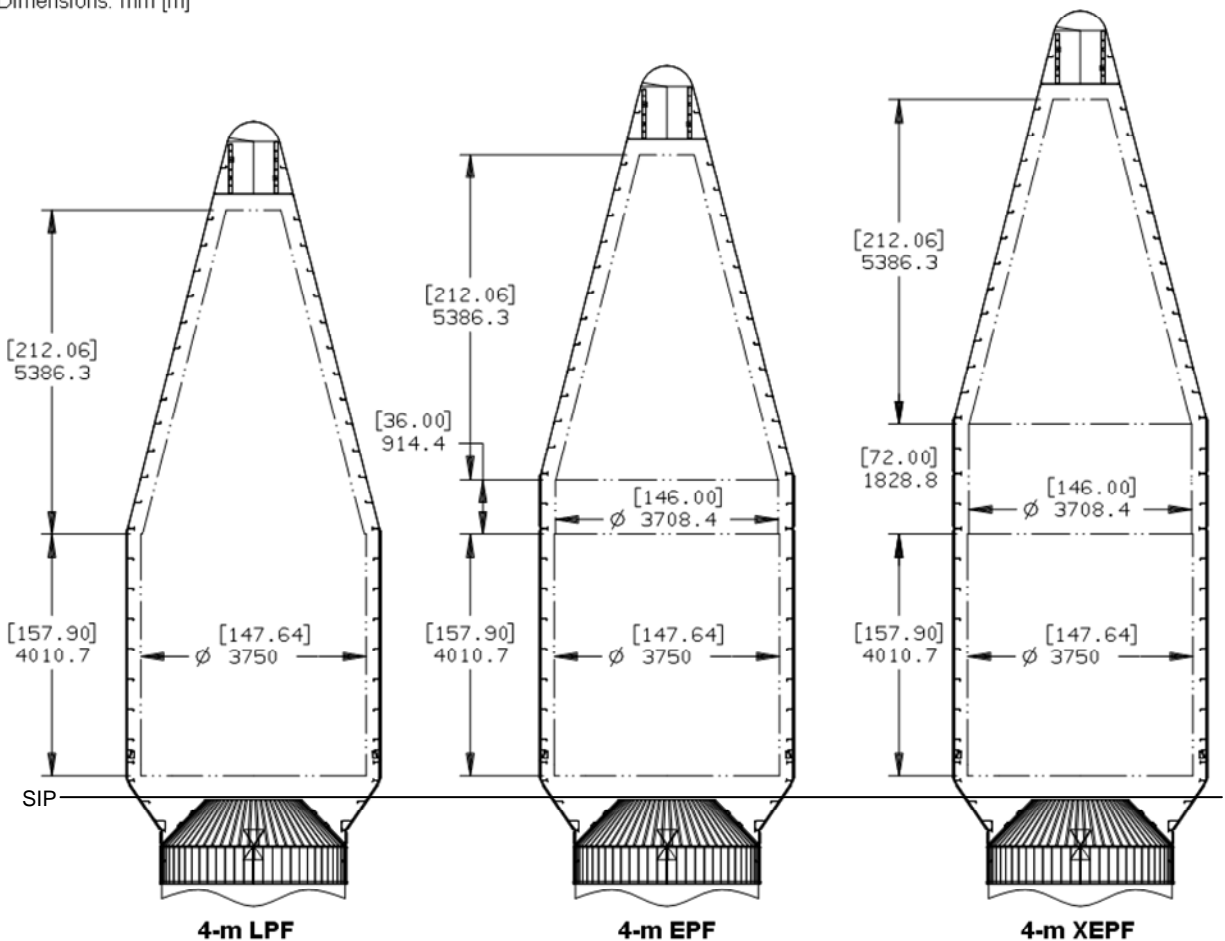
Figure 6-2: Atlas V Vehicle Lengths with Payload Fairing Options



The static payload envelope defines the usable volume for a spacecraft. This envelope represents the maximum allowable spacecraft static dimensions (including manufacturing tolerances) relative to the spacecraft and payload adapter interface. Some increases in diameter may be allowed on a mission-unique basis, but must be analyzed. For clearances between the spacecraft and PLF, primary clearance concerns are for dynamic deflections of the spacecraft and PLF and the resulting relative loss of clearance between these components. For clearances between the spacecraft and Payload Adapter (PLA), primary envelope concerns include access to the mating components and payload separation system for integration and installation operations, motion of the payload separation system during its operation, and movement of the spacecraft and launch vehicle after separation of the spacecraft. For all static payload envelopes, clearance layouts and analyses are performed for each spacecraft configuration, and if necessary, critical clearance locations are measured during spacecraft and launch vehicle integration operations to ensure positive clearance maintenance. Figure 6-3 shows the overall, simplified views of static payload envelopes for Atlas V 400 series launch vehicle configurations; Figure 6-4 shows these views for the Atlas V 500 series launch vehicle configurations. Detailed descriptions and figures are included in Section 6.1 for the 4-m fairing and Section 6.2 for the 5-m fairing.

**Figure 6-3: Atlas V 4-m Simplified Static Payload Envelopes**

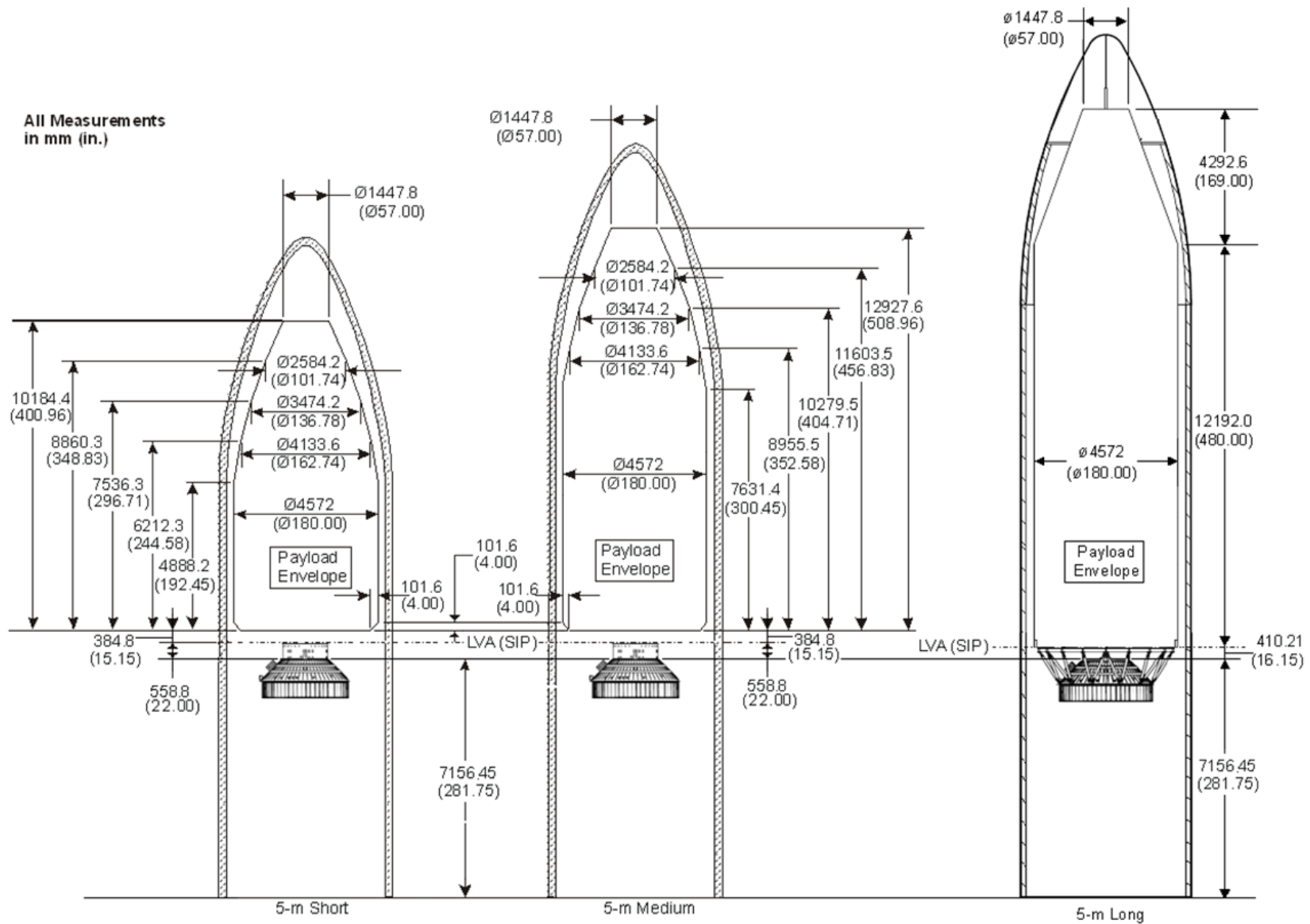
Dimensions: mm [in]



AVUG11\_F06\_03b



Figure 6-4: Atlas V 5-m Simplified Static Payload Envelopes



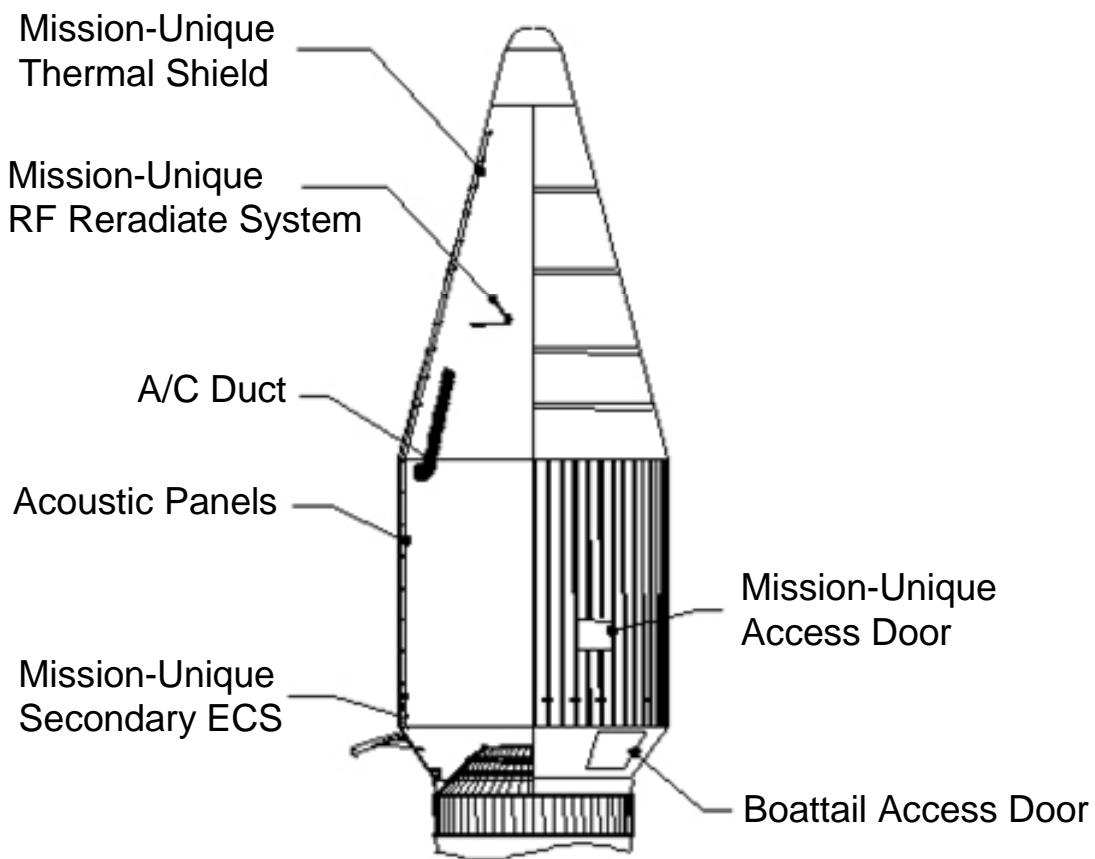
AVUG11\_F06\_04c

### 6.1 ATLAS V 4-M PAYLOAD FAIRINGS

The Atlas V Large Payload Fairing (LPF), Extended Payload Fairing (EPF), and Extra Extended Payload Fairing (XEPP) have a common 4.2-m (165-in) diameter cylindrical section topped by a conical section. Figure 6.1-1 shows the PLF interface features and Figures 6.1-2 through 6.1-4 depict the three PLF configurations. Major sections of these payload fairings are the boattail, the cylindrical section, and the nose cone that is topped by a spherical cap. Atlas V developed the EPF to support launches of larger-volume spacecraft by adding a 0.9-m (36-in.) high cylindrical plug atop the cylindrical section of the LPF. The XEPP is a modified version of the EPF that incorporates an additional 0.9-m (36-in.) high cylindrical plug to further increase the available payload volume.

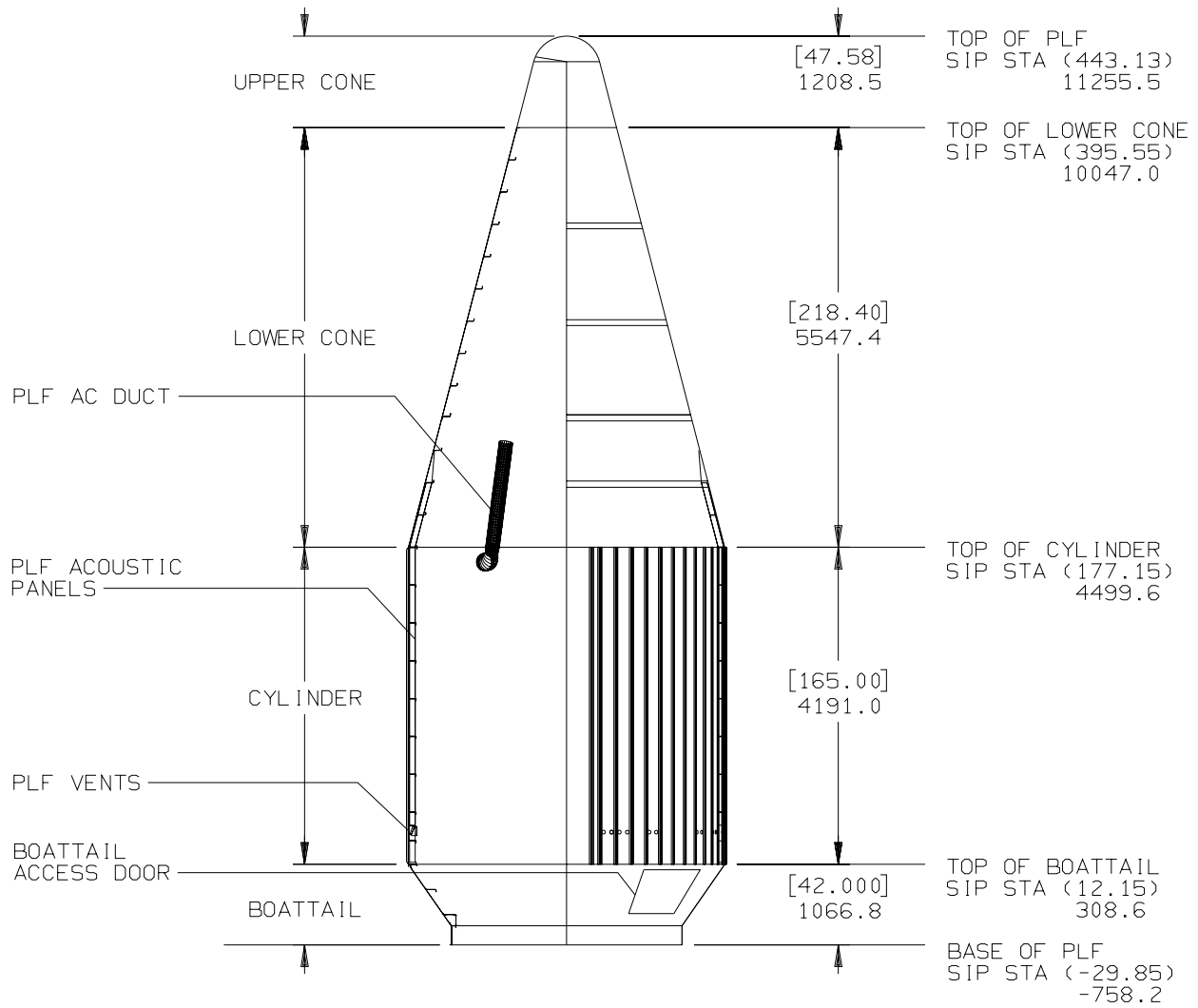
Additional mission-unique items can be mounted on the PLF to provide support services to the spacecraft. Figure 6.1-1 shows these standard and mission-unique features.

Figure 6.1-1: Atlas V 4-m Payload Fairing Interface Features



AVUG11\_F0601\_01d

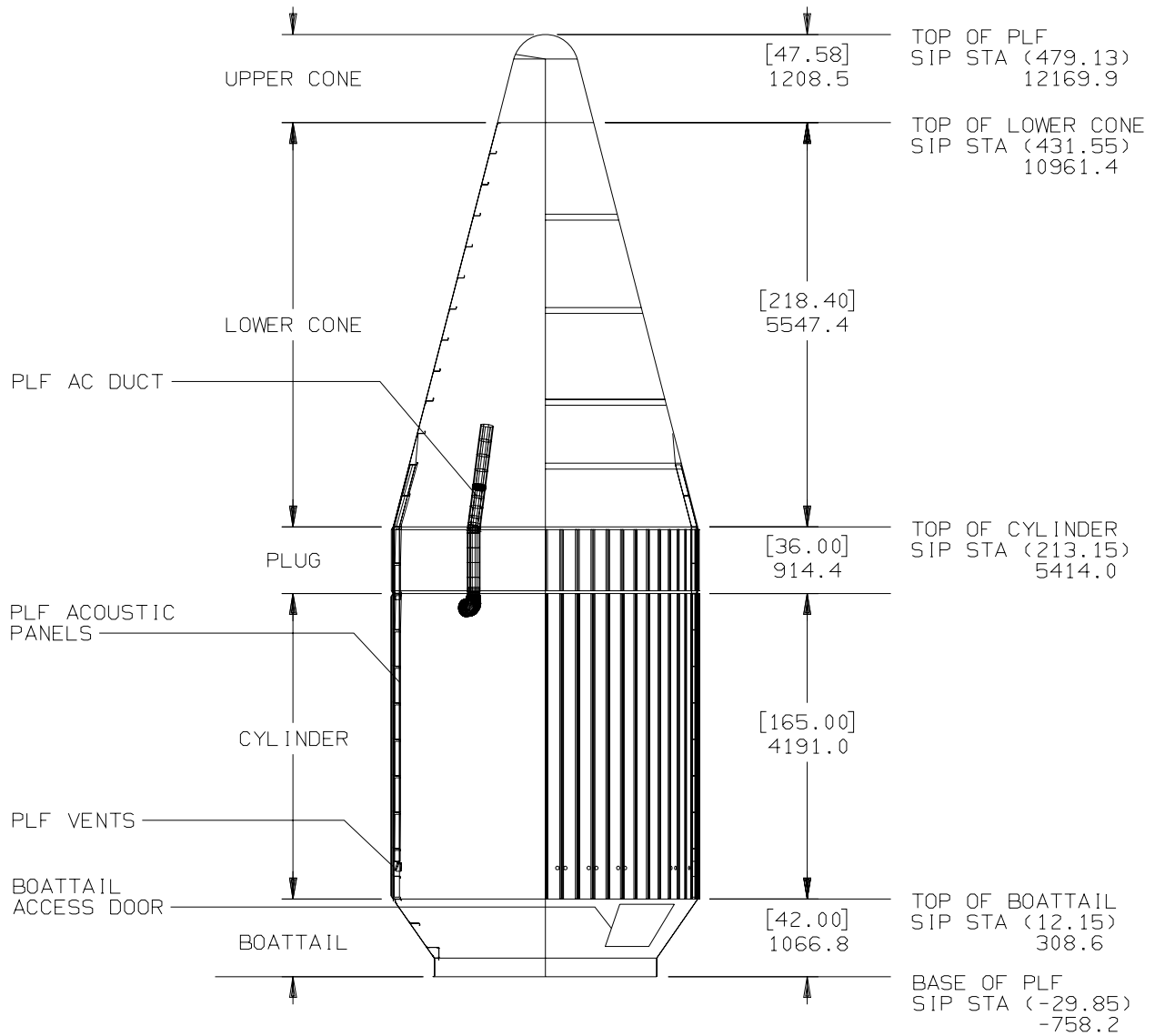
Figure 6.1-2: Atlas V 4-m Large Payload Fairing (LPF)



AVUG11\_F0601\_02b

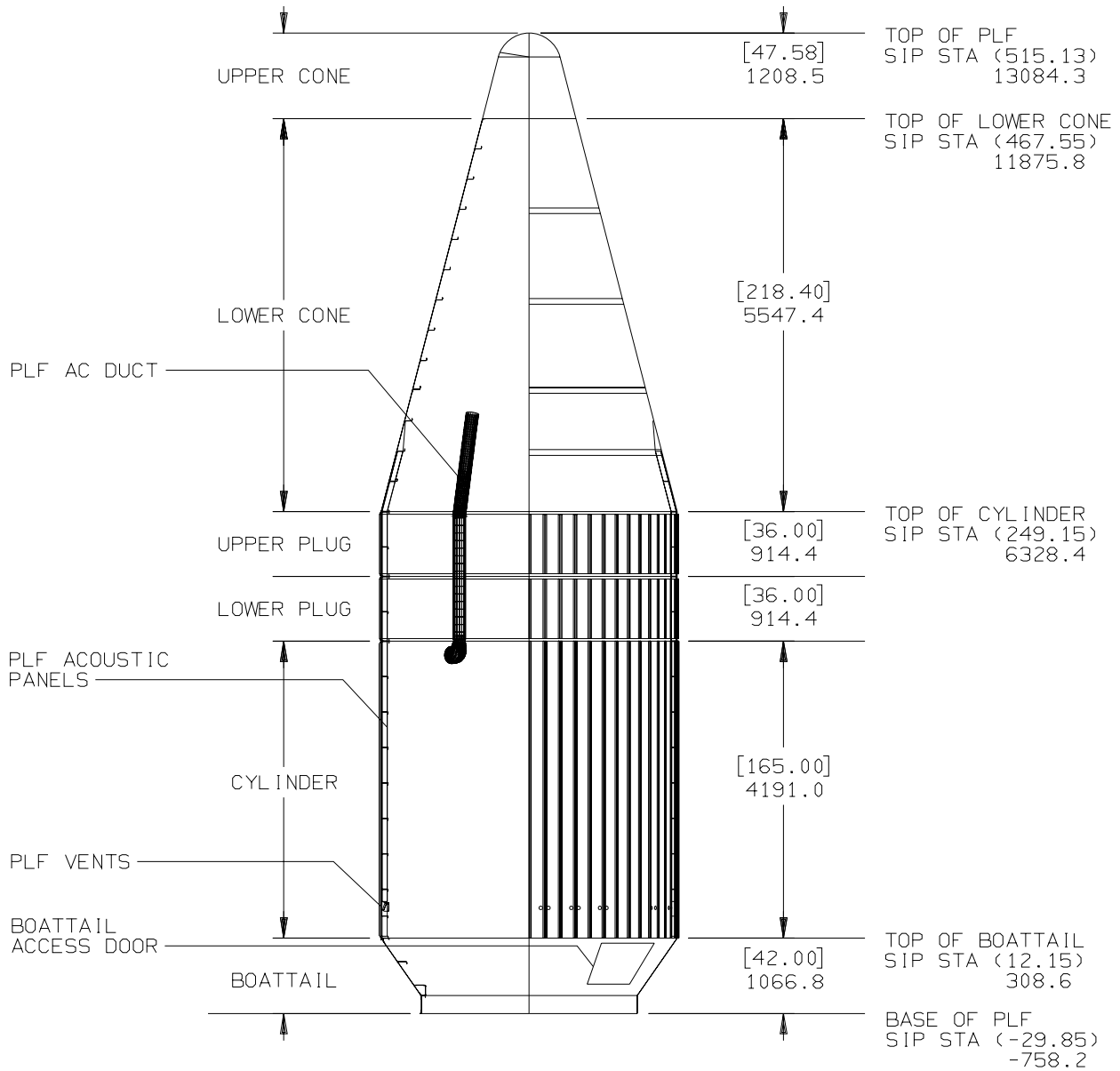


Figure 6.1-3: Atlas V 4-m Extended Payload Fairing (EPF)



AVUG11\_F0601\_03b

Figure 6.1-4: Atlas V 4-m Extra Extended Payload Fairing (XEPF)



AVUG11\_F0601\_04b

### 6.1.1 Atlas V 4-m Static Payload Envelope

The static payload envelope defines the usable volume for a spacecraft inside the PLF. The Atlas V 4-m PLF provides a 3,750-mm (147.64-in.) diameter envelope in the cylindrical section, as shown in Figure 6.1.1-1, with additional volume available in the conical section of the PLF. On a mission-unique basis, the envelope may be increased to a 3,850-mm (151.57-in.) diameter in localized areas by modifying portions of the PLF structure. This envelope represents the maximum allowable spacecraft static dimensions (including manufacturing tolerances) relative to the spacecraft/payload adapter interface. These envelopes include allowances for PLF static tolerances and misalignments, PLF and spacecraft dynamic deflections, and PLF out-of-round conditions, and were established to ensure a minimum 25-mm (1-in.) clearance between the spacecraft and the PLF. These envelopes are applicable for spacecraft that meet the stiffness and load requirements discussed in Section 3.2.1. Clearance layouts and analyses are performed for each spacecraft configuration and, if necessary, critical clearance locations are measured after the spacecraft is encapsulated inside the fairing to verify positive clearance during flight. Isometric views of the bottom and overall static payload envelopes for the LPF, EPF and XEPF appear in Figure 6.1.1-2, while detailed views appear in Figures 6.1.1-3 to 6.1.1-6.

For customers who request a dynamic payload envelope, the static payload envelopes shown in Figures 6.1.1-1 and 6.1.1-2 can be conservatively used for preliminary design purposes. These envelopes meet the requirements for dynamic payload envelopes of the Evolved Expendable Launch Vehicle (EELV) Standard Interface Specification (SIS). The static payload envelopes were based on a combination of flight, jettison, and ground handling conditions, and the spacecraft dynamic deflections are only a consideration during flight conditions. Mission-unique modifications to these envelopes, either on a static or dynamic basis, depend on the spacecraft configuration and dynamic behavior of the spacecraft.

Figure 6.1.1-1: Atlas V 4-m PLF Static Payload Envelope, 3,850-mm Diameter

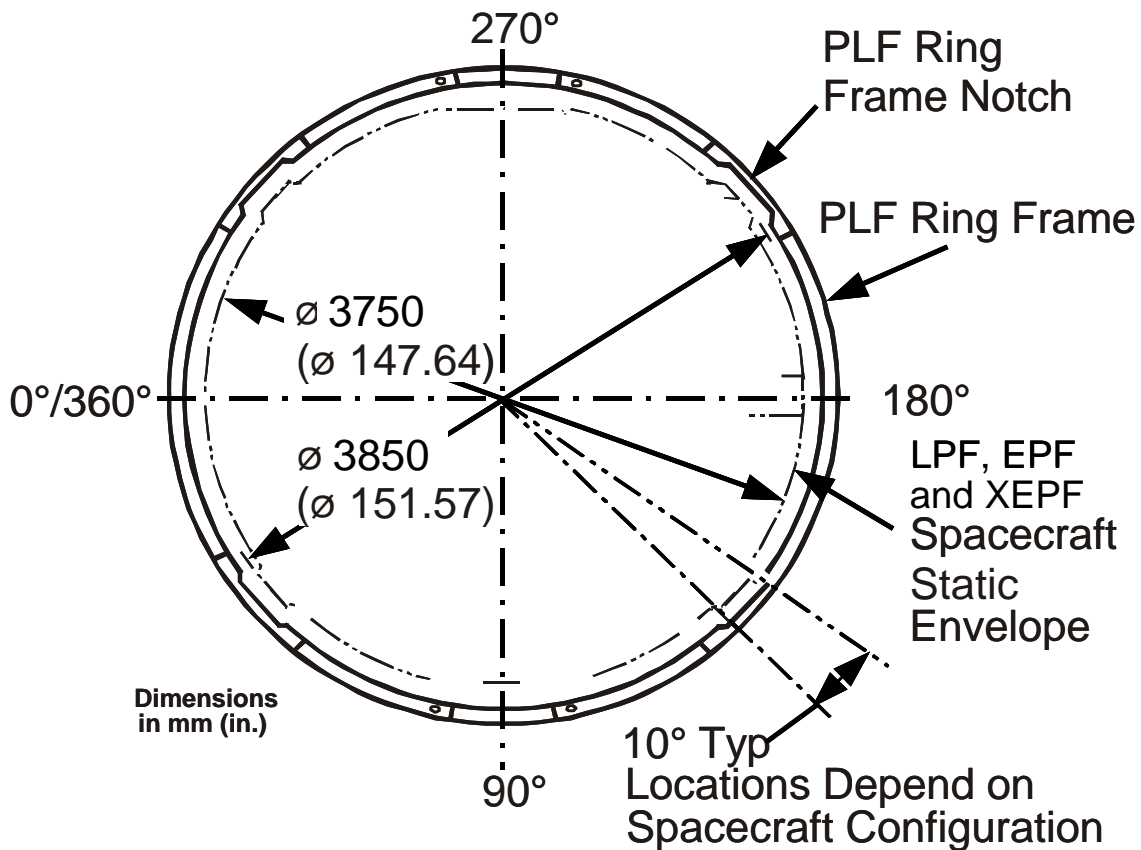
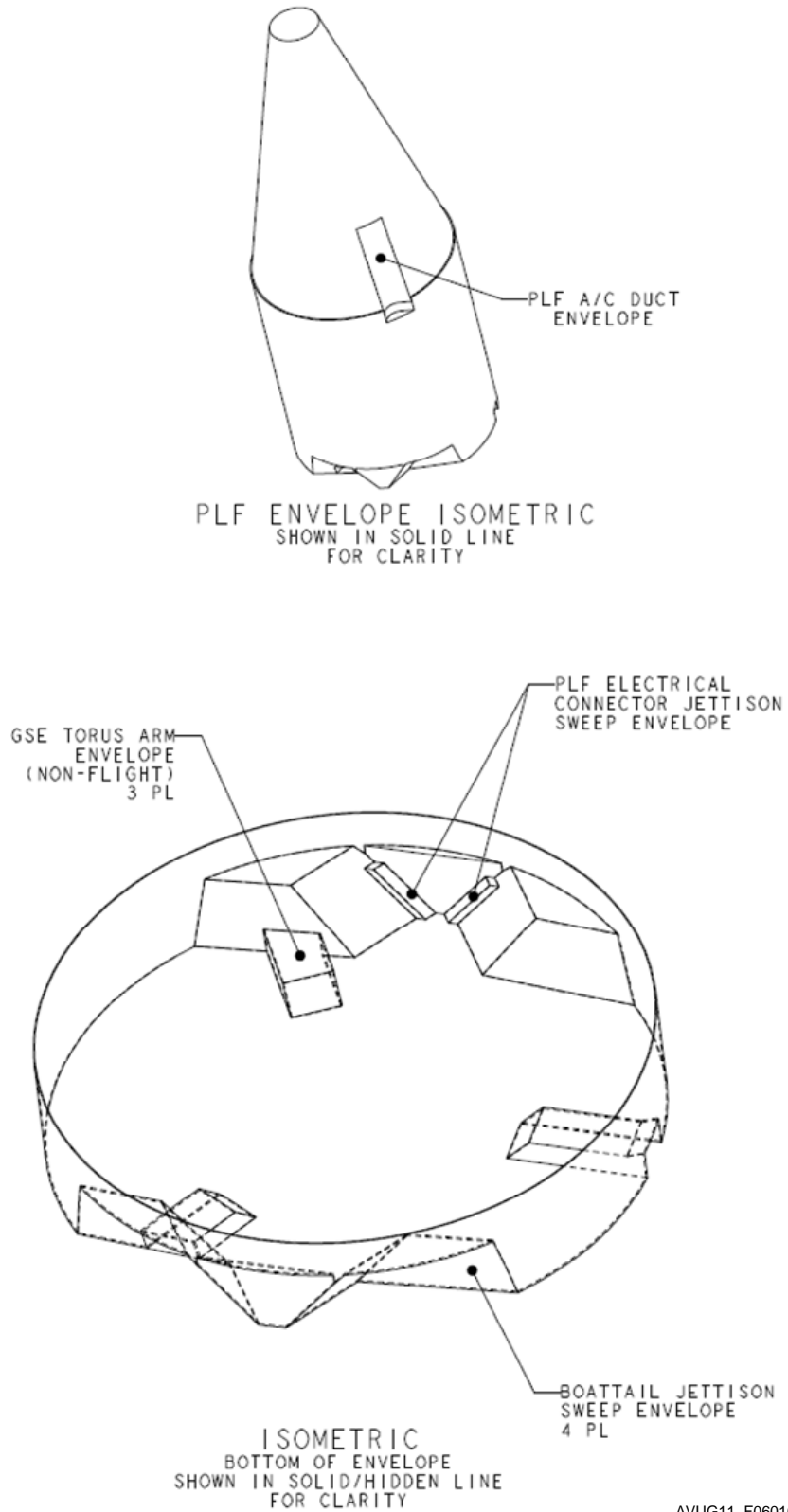
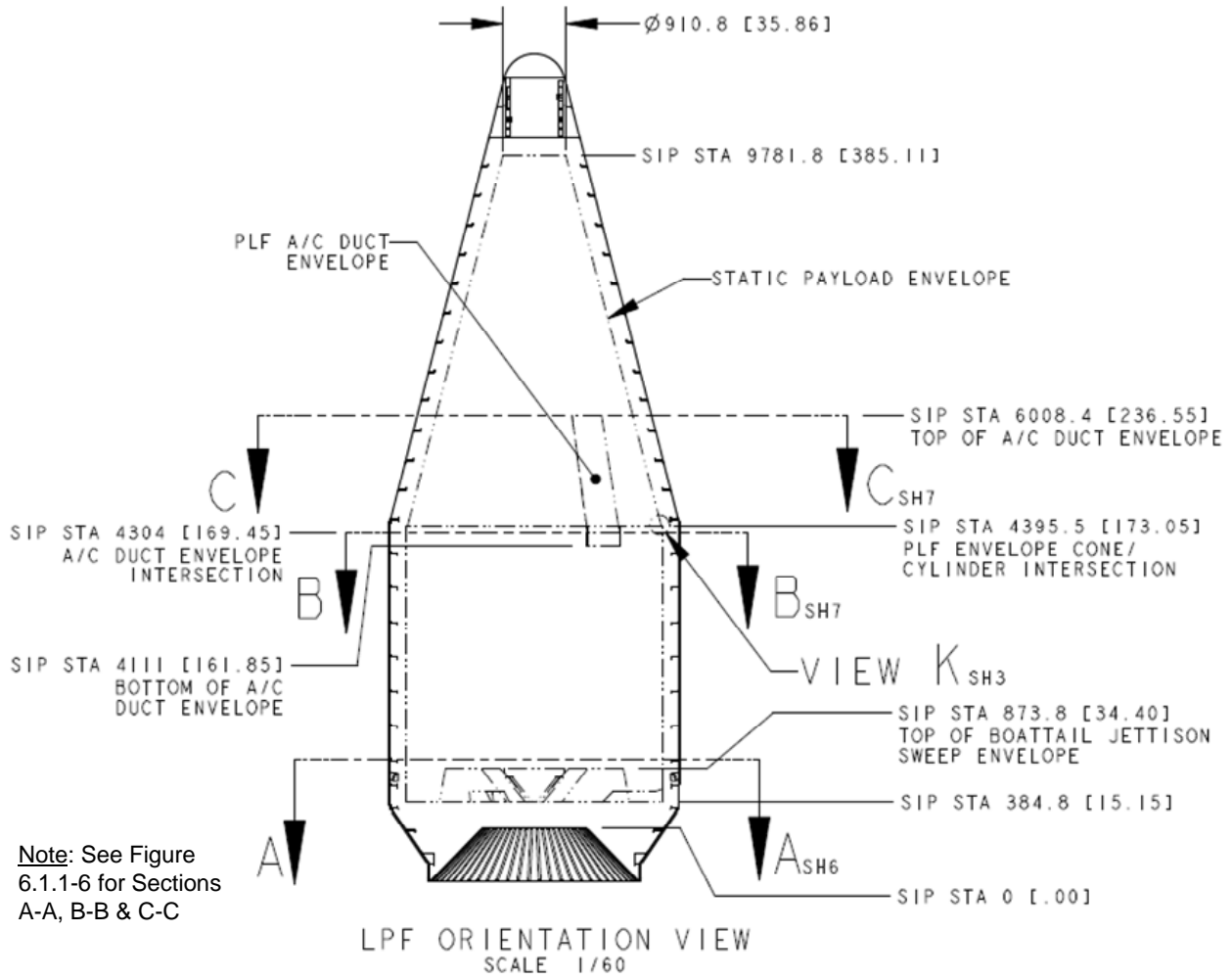


Figure 6.1.1-2: Atlas V 4-m Isometric Views of the PLF Static Payload Envelope

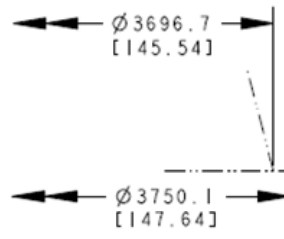


AVUG11\_F060101\_02a

Figure 6.1.1-3: Atlas V 4-m LPF Static Payload Envelope



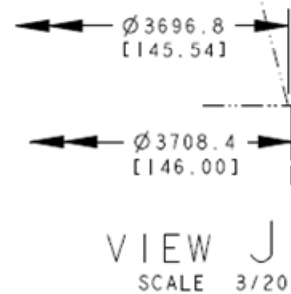
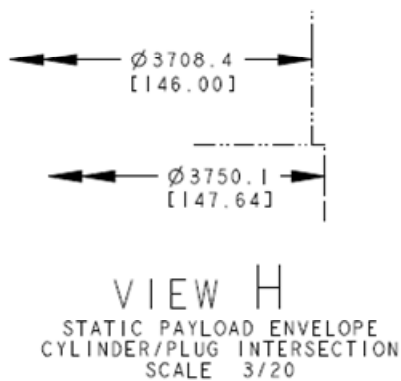
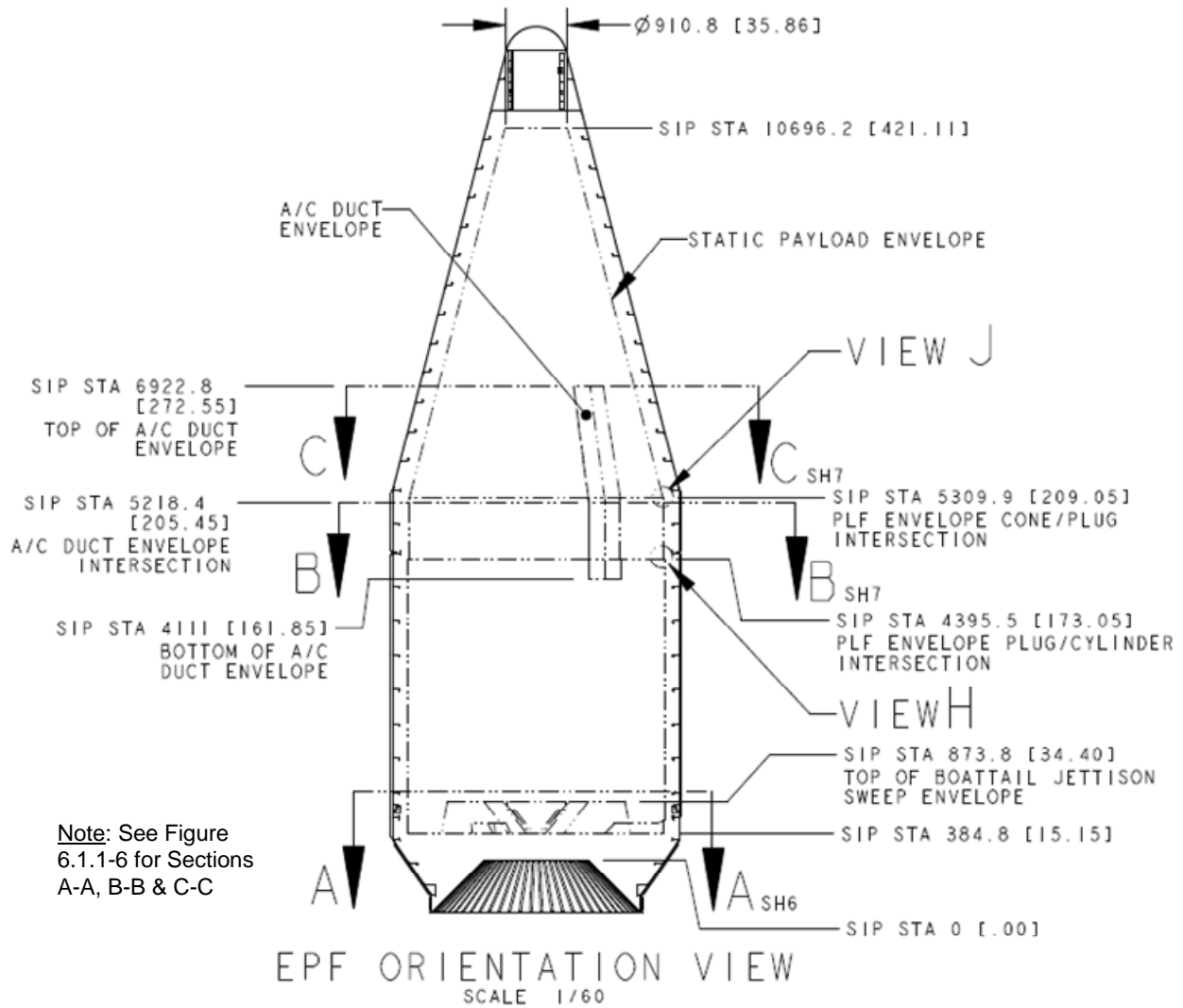
Note: See Figure 6.1.1-6 for Sections A-A, B-B & C-C



VIEW K<sub>SH3</sub>  
 PLF ENVELOPE  
 CONE/CYLINDER  
 INTERSECTION  
 SCALE 3/20

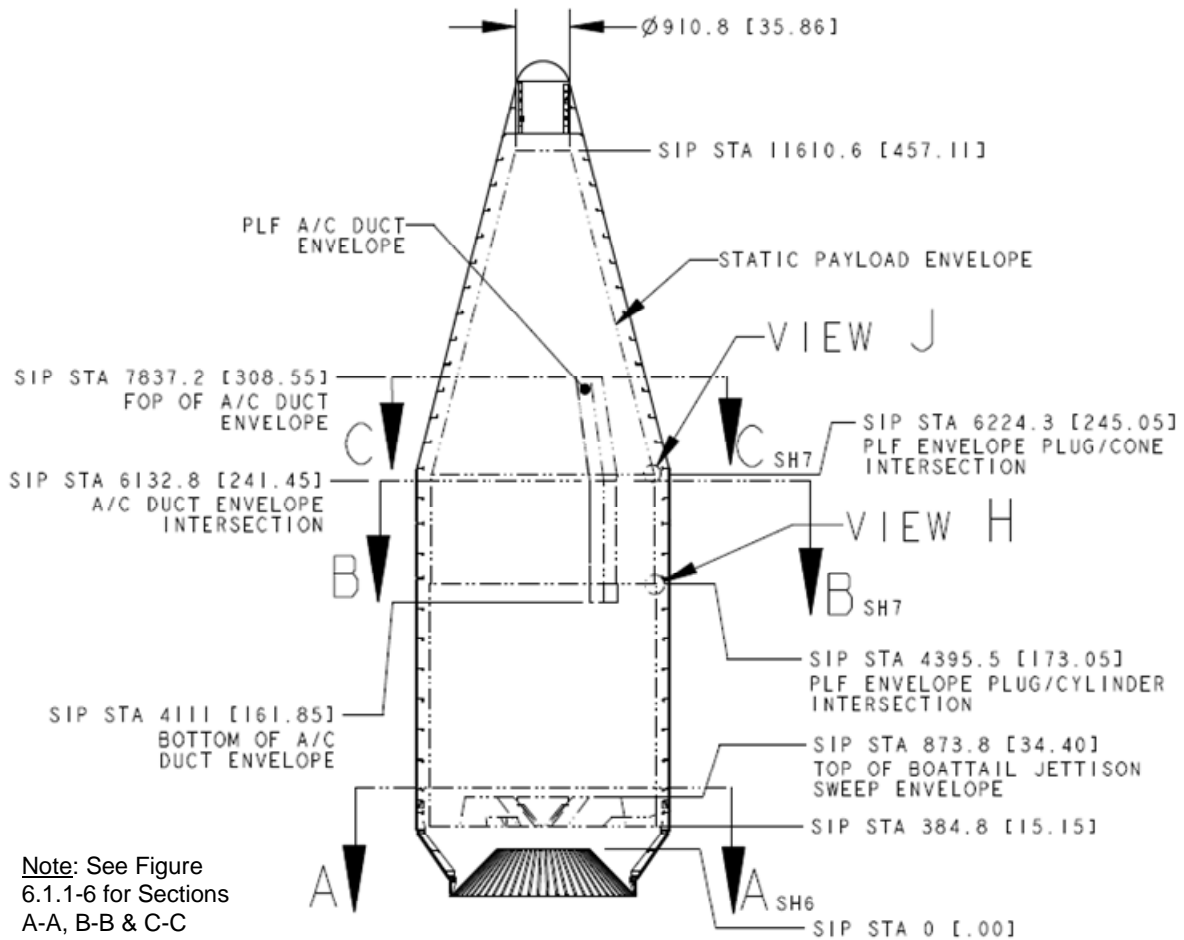
AVUG11\_F060101\_03a

Figure 6.1.1-4: Atlas V 4-m EPF Static Payload Envelope



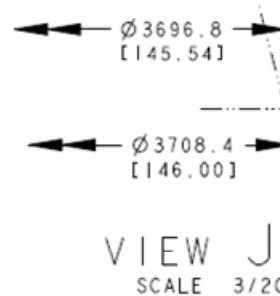
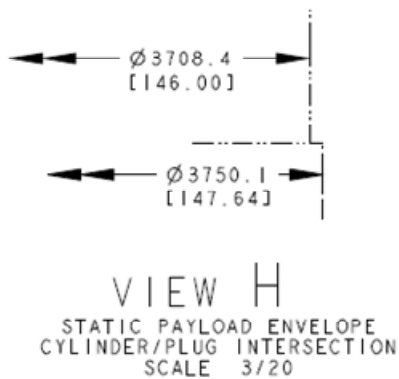
AVUG11\_F060101\_04b

Figure 6.1.1-5: Atlas V 4-m XEPF Static Payload Envelope



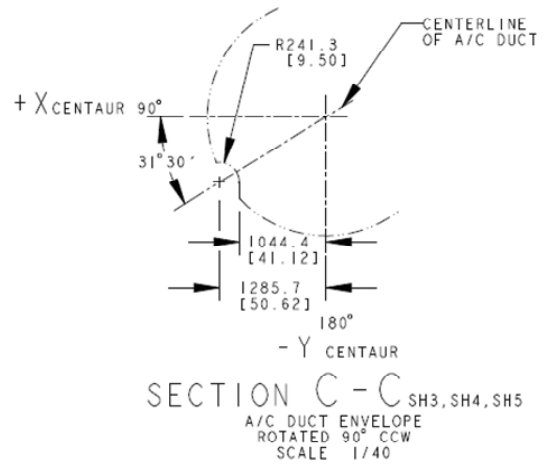
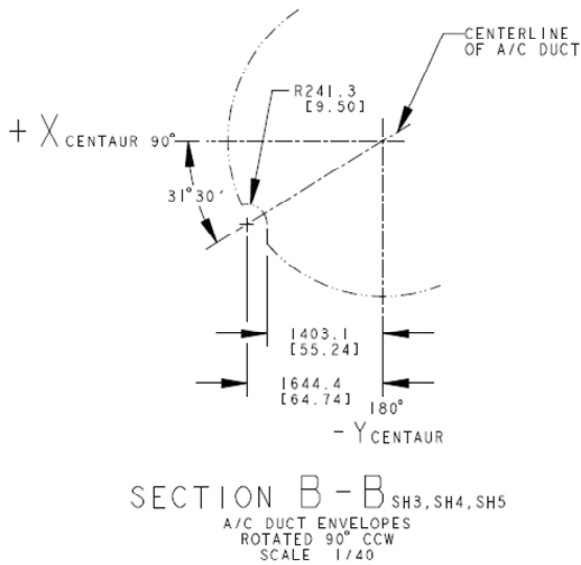
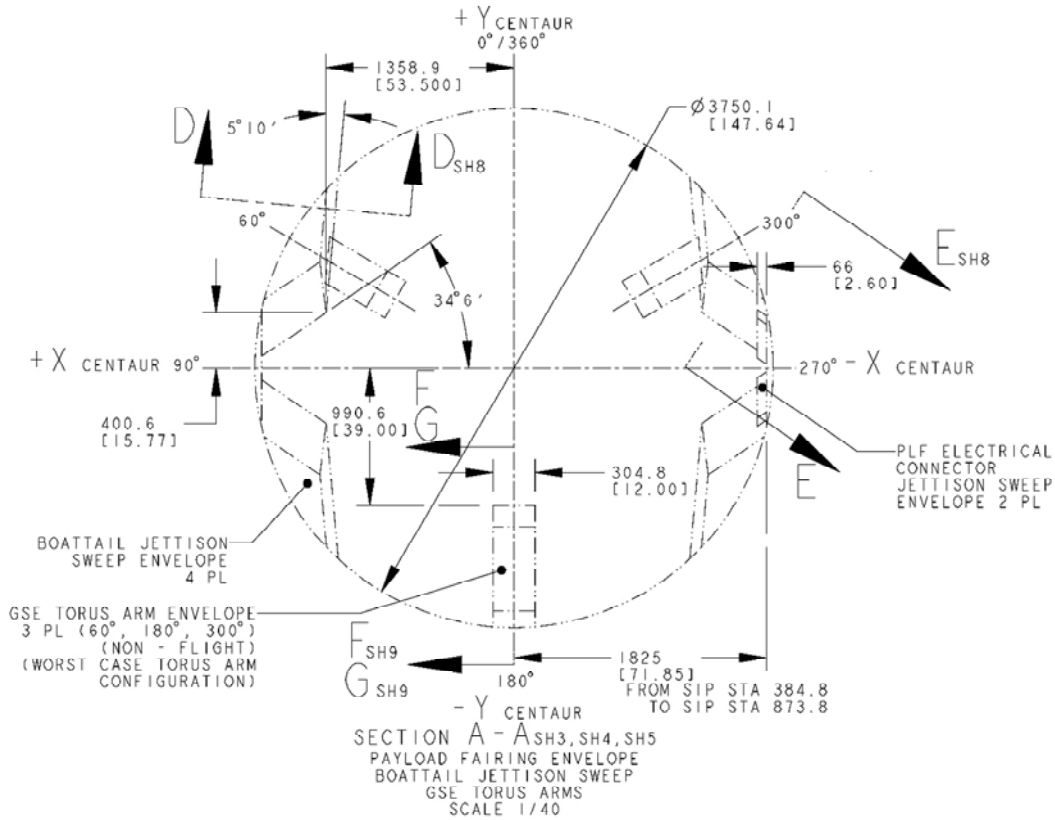
Note: See Figure 6.1.1-6 for Sections A-A, B-B & C-C

XEPF ORIENTATION VIEW  
 SCALE 1/72



AVUG11\_F060101\_05b

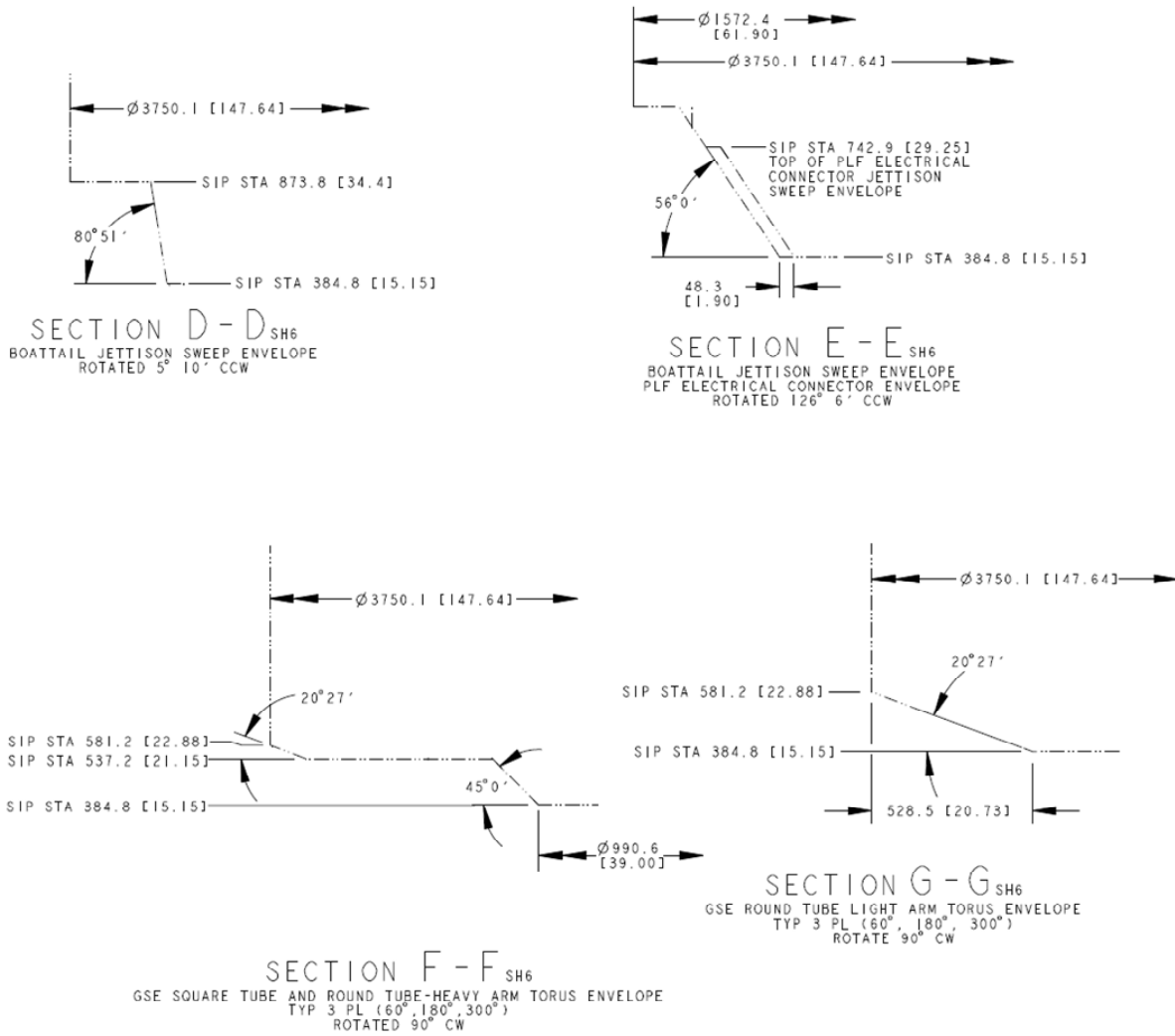
Figure 6.1.1-6: Atlas V 4-m LPF, EPF, XEPF Static Payload Envelope Common Views (1 of 2)



AVUG11\_F060101\_06\_1of2b



Figure 6.1.1-6: Atlas V 4-m LPF, EPF, XEPF Static Payload Envelope Common Views (2 of 2)

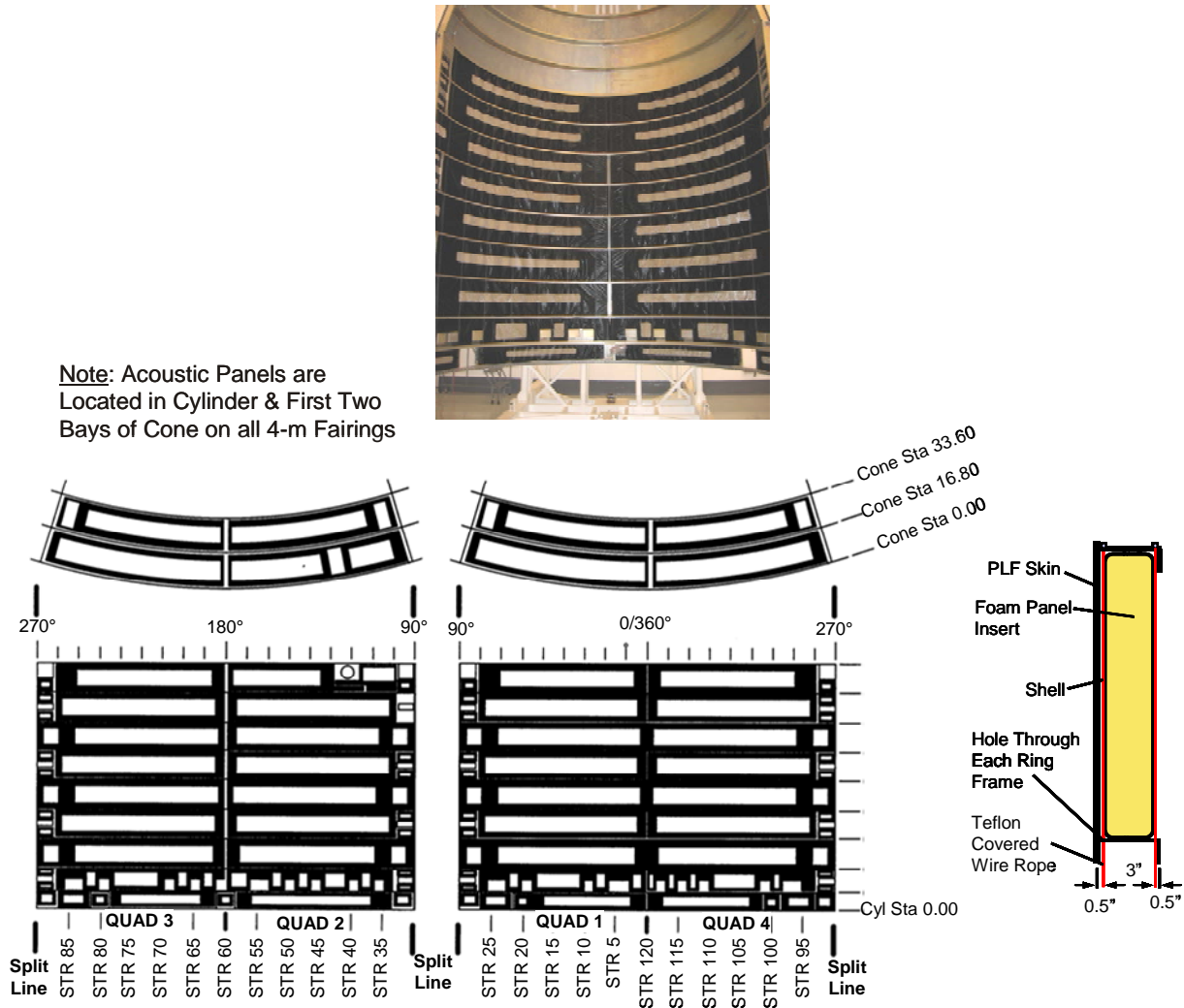


AVUG11\_F060101\_06\_2of2a

6.1.2 Payload Compartment Environmental Control

The Atlas V 4-m PLF provides a suitable acoustic, thermal, electromagnetic, and contamination controlled environment for its payload. The acoustic panels (Figure 6.1.2-1) attach to the cylindrical section of the fairing and the first two bays of the cone to attenuate the sound pressure levels to acceptable limits (Section 3.2.2).

Figure 6.1.2-1: Atlas V 4-m PLF Acoustic Panels



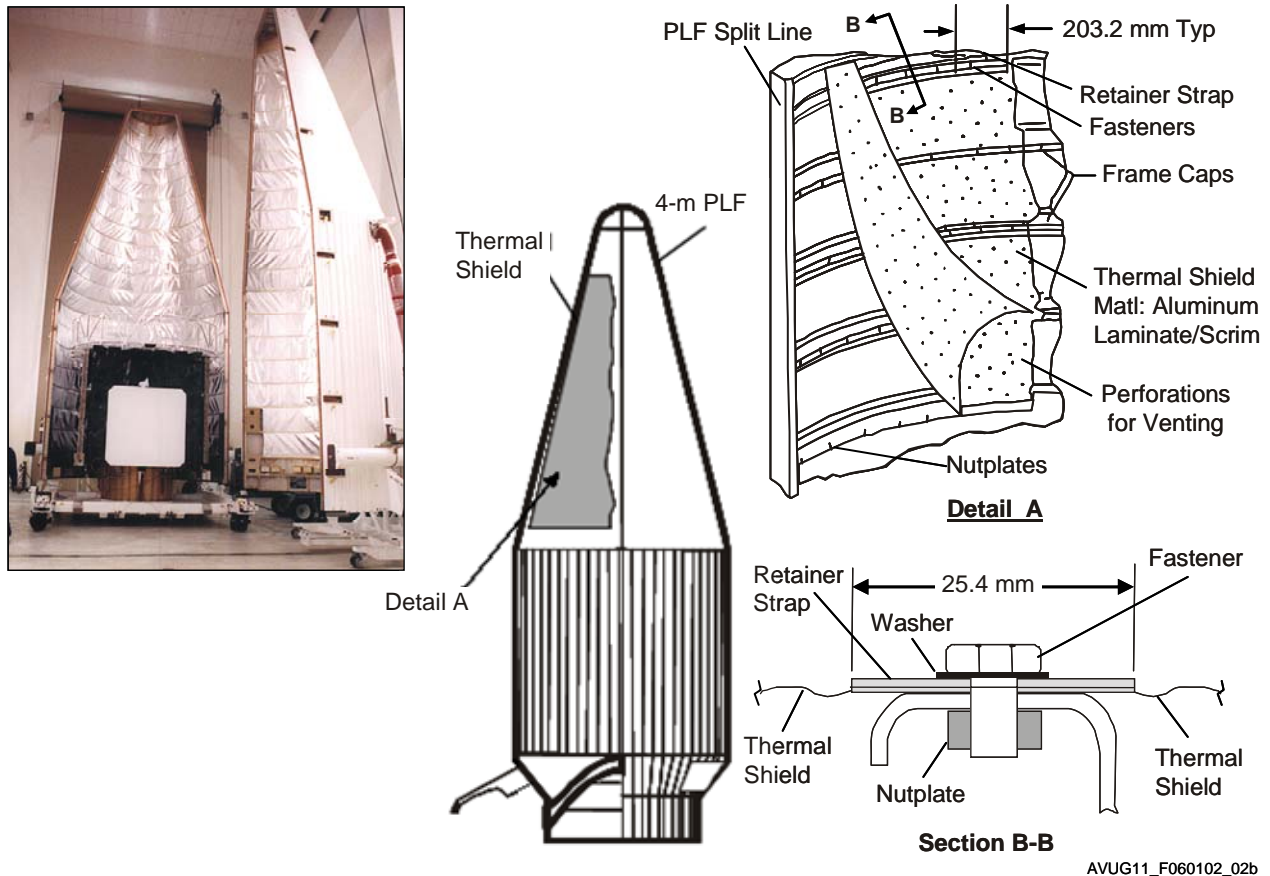
AVUG11\_F060102\_01b

For thermal control, the external surface of the conical section fairing is insulated with cork to limit temperatures to acceptable values (Sections 3.1.1 and 3.2.5). Non-contaminating, low-emittance thermal control coatings are used on payload fairing internal surfaces to reduce incidental heat fluxes to the spacecraft. The acoustic panels located in the cylindrical section of the PLF also serve to reduce heating in the payload compartment. As a mission-unique option, thermal shields (Figure 6.1.2-2) may be added in the conical section of the fairing, above the acoustic panels, to provide additional thermal control. During prelaunch activities, conditioned air is provided through the air-conditioning duct located in the upper cylindrical and lower conical portion of the fairing. This duct directs conditioned air to provide thermal and humidity control upward into the conical section to avoid direct impingement on the spacecraft. Vent holes and housings are mounted on the lower part of the cylindrical section of the PLF to allow air from the air-conditioning system to exit the fairing and to allow depressurization during ascent. As a mission-unique option a secondary environmental control system may be added to provide additional cooling or to direct cooling air to specific points on the payload.

The metallic construction of the fairing provides some electromagnetic shielding for the spacecraft and may serve to attenuate external Radio Frequency (RF) environment and all access doors and entry points are sealed during ground operations. Electrically conductive seal materials are used between mating surfaces on the PLF to reduce entry paths for RF signals. For analysis purposes, Atlas V assumes 0 decibel (dB) of shielding for a standard PLF and assumes 6 decibel (dB) after PLF closeout and during ascent. Higher levels of RF shielding can be achieved with mission unique modifications to the PLF.

The PLF is fabricated and operated according to requirements of the Atlas contamination control plan described in Section 3.1.3. This plan establishes rigorous procedures to ensure that all hardware that comes into close proximity with the payload meets cleanliness requirements and may be tailored to meet mission-unique payload requirements.

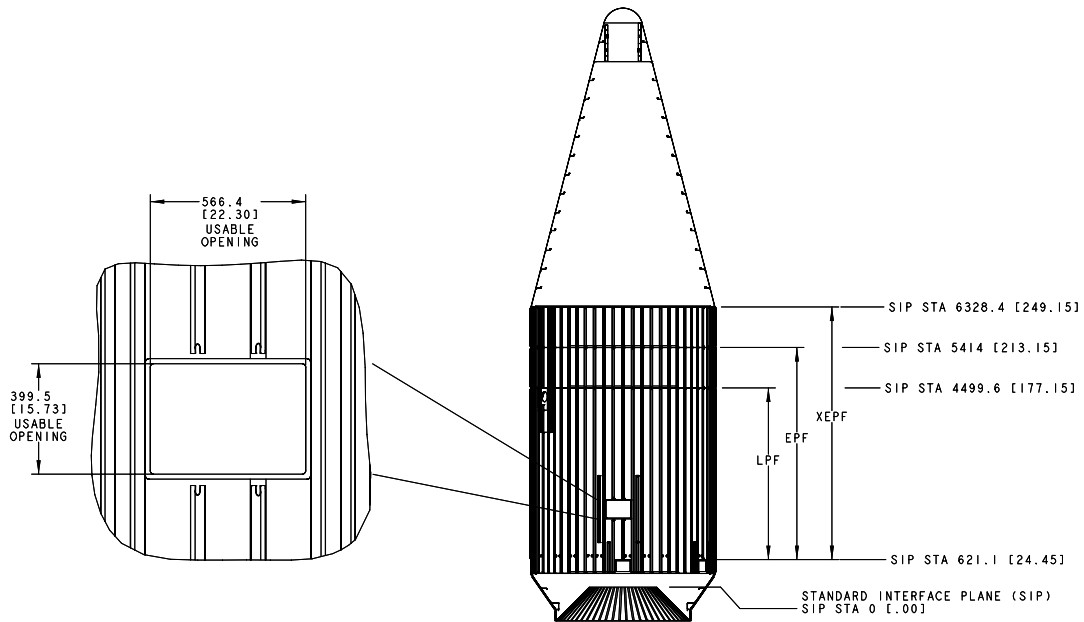
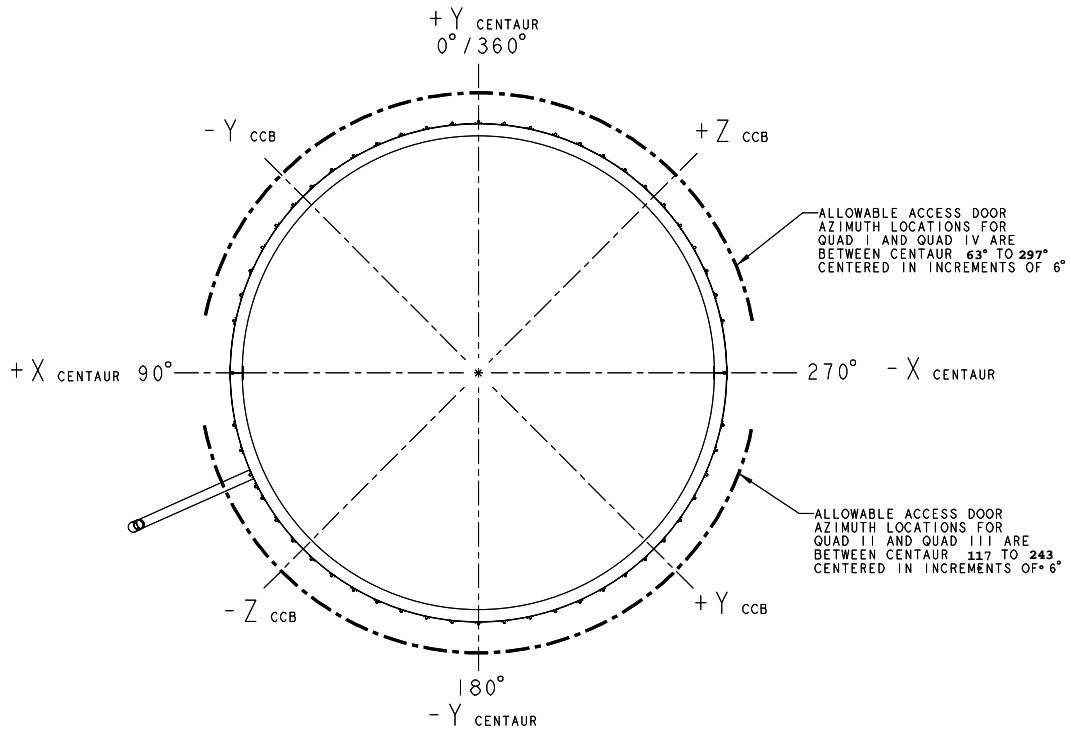
Figure 6.1.2-2: Atlas V 4-m PLF Thermal Shields



### 6.1.3 Payload Access

The four large doors in the boattail section of the 4-m PLF provides primary access to Centaur forward adapter packages and the encapsulated spacecraft. Work platforms can be inserted into the payload compartment through these doors to allow access to spacecraft hardware near the aft end of the payload compartment. If additional access to the spacecraft is required, doors can be provided on a mission-unique basis on the cylindrical section of each PLF. Figure 6.1.3-1 shows the available standard sizes and allowable locations for these doors. Larger doors can be accommodated as a mission-unique option. Access is permitted from the time of payload encapsulation until closeout operations prior to launch operations.

Figure 6.1.3-1: Atlas V 4-m PLF Access Doors



AVUG11\_F60103\_01a

### 6.1.4 Payload RF Communications

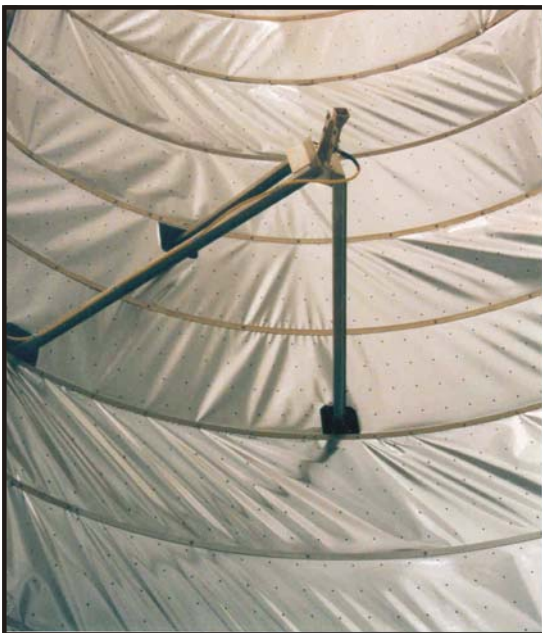
The aluminum 4-m PLF provides some electromagnetic shadowing from external RF sources; however, apertures and openings preclude it from being an effective RF shield, particularly at frequencies above 1 Gigahertz (GHz), without significant mission-unique modifications.

A reradiating system is a mission-unique modification that allows payload RF telemetry transmission and command receipt communications after the payload is encapsulated in the spacecraft until launch. The airborne system consists of an antenna, a mounting bracket, and cabling inside the PLF. Reradiating antennas are available in S-, C-, and Ku-bands. The pick-up antenna is mounted on a bracket at a location appropriate for the spacecraft configuration (Figure 6.1.4-1). This antenna acquires the spacecraft RF signal and routes it via RF cabling to PLF T-0 disconnect. A cable runs from the T-0 disconnect to a junction box that routes the signal to a customer-specified location. It must be noted that radiating RF inside an enclosed fairing will produce an enhanced resonant environment that may be in excess of spacecraft or launch vehicle limits. ULA will perform an Electromagnetic Compatibility (EMC) analysis to evaluate this condition early in the integration process.

### 6.1.5 Customer Logo

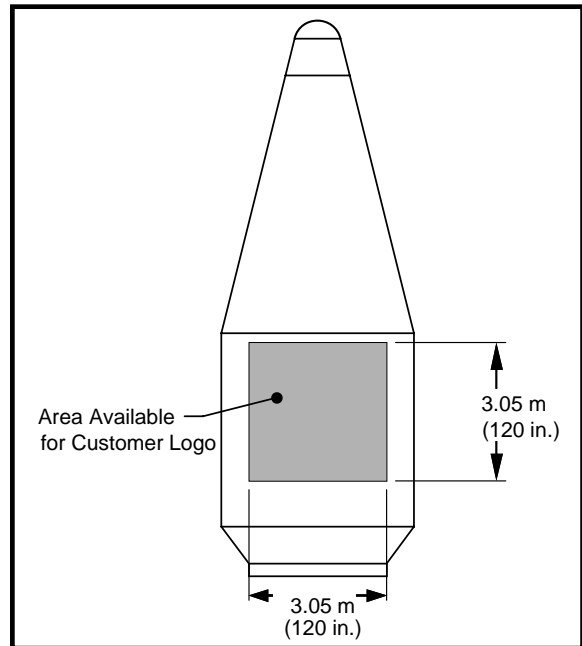
A customer-specified logo may be placed on the cylindrical section of the PLF. Logos up to 3.05 x 3.05 m (10 x 10 ft.) are provided as a standard service. Figure 6.1.5-1 shows the area of the PLF reserved for customer logos. The ULA Customer Program Office works with customers and provides logo layout options on the launch vehicle to assist in determining proper size and location.

Figure 6.1.4-1: Atlas V 4-m PLF RF Reradiate Antenna Installation



AVUG11\_F060104\_01a

Figure 6.1.5-1: Atlas V 4-m PLF Customer Logo Provisions

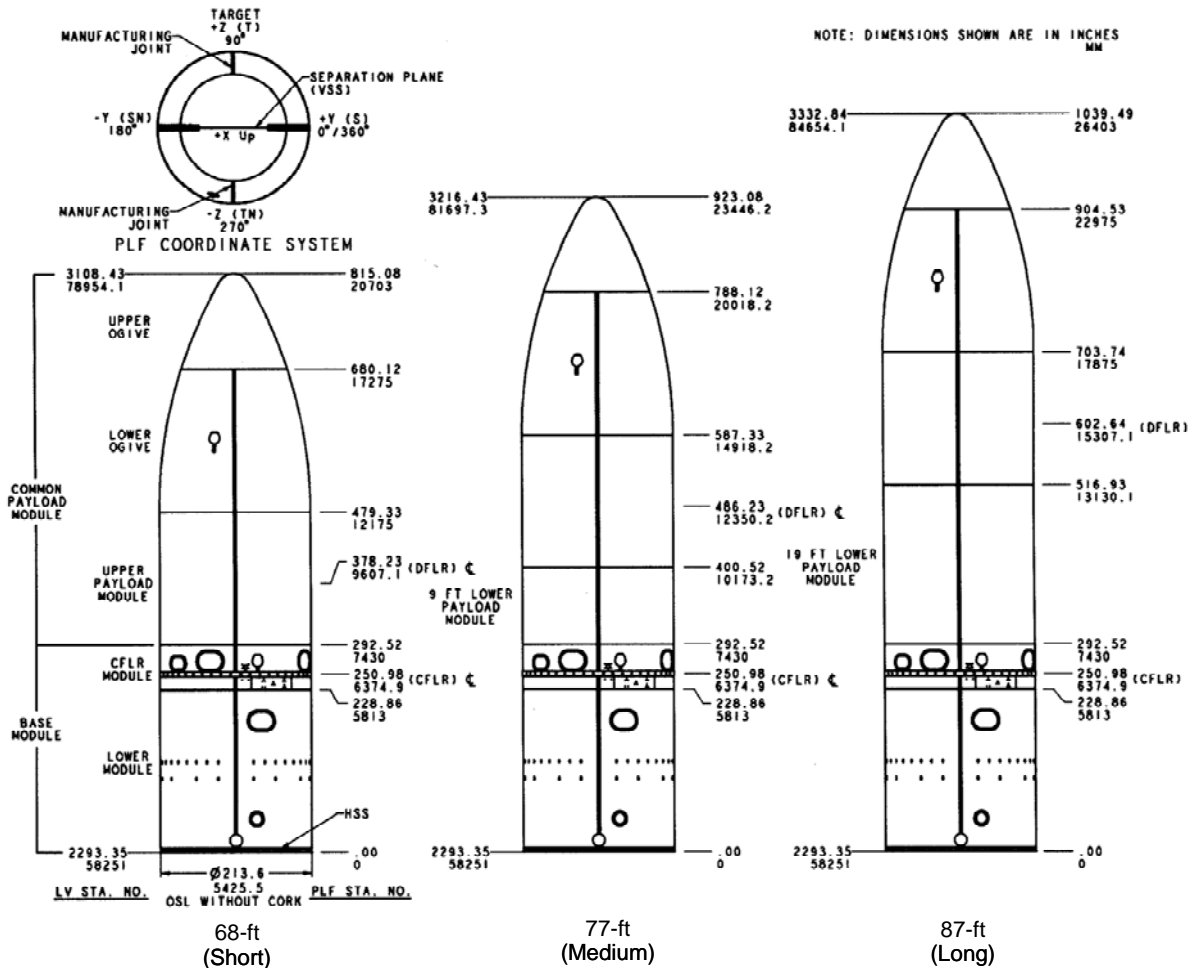


AVUG11\_F060105\_01b

### 6.2 ATLAS V 5-M PAYLOAD FAIRINGS

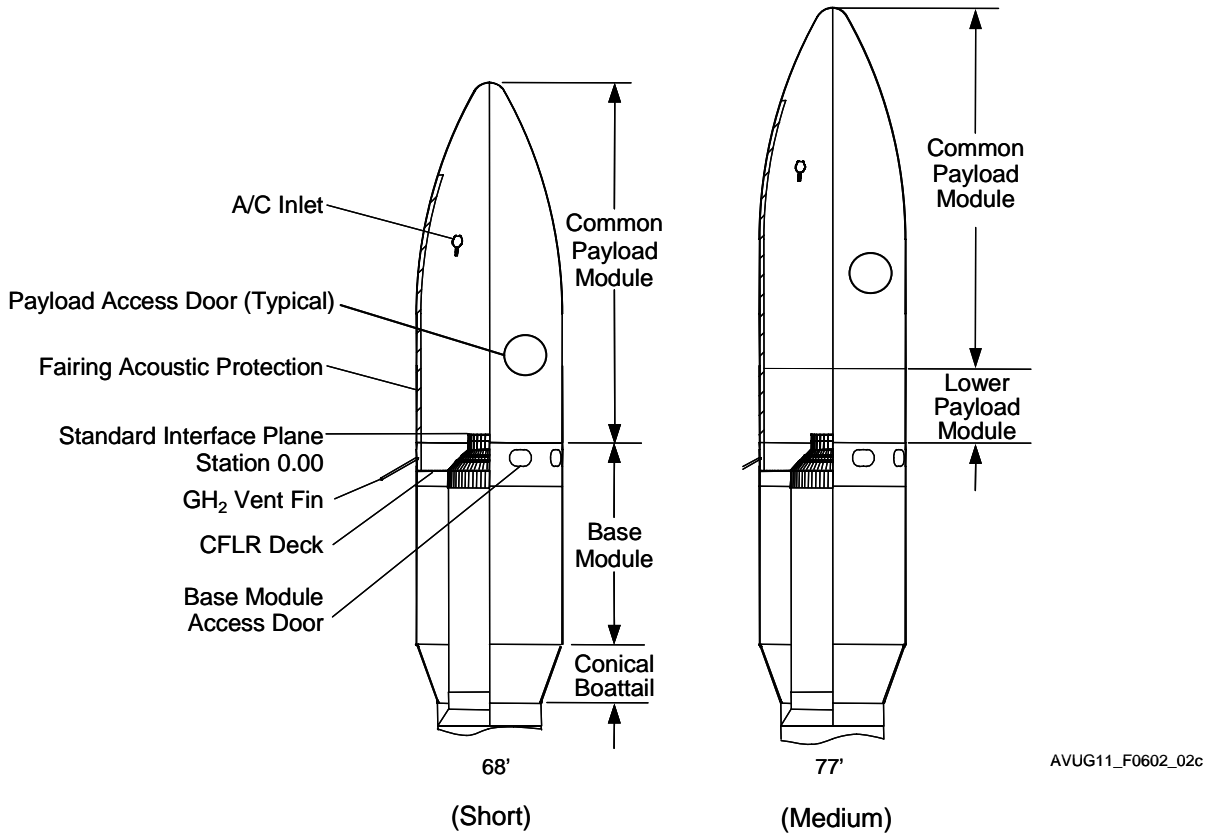
The Atlas V 5-m diameter PLF was developed along with the increased launch vehicle performance to accommodate growing spacecraft volume requirements. The PLF and boattail provide a protective enclosure for the spacecraft and Centaur during prelaunch operations and launch vehicle ascent. The 5-m short (68 ft.), medium (77 ft.), and long (87 ft.) length PLFs have a 5.4-m (213.6-in.) outer skin line diameter cylindrical section. The 5-m PLF is a bisector payload fairing with a composite structure made from sandwich panels with composite facesheets and a vented aluminum honeycomb core. There are two major components of the bisector payload fairing: the Base Module (BM) and the Common Payload Module (CPM). The BM is the lower section of the PLF that encapsulates the Centaur upper stage. The CPM is the upper section of the PLF that encapsulates the spacecraft. The CPM consists of a cylindrical section that transitions into a constant radius ogive nose section topped by a spherical nose cap as shown in Figure 6.2-1. The ogive shape minimizes aerodynamic drag and buffet during booster ascent. The 5-m medium PLF adds a 2,743-mm (108-in.) Lower Payload Module (LPM) to the base of the CPM to increase the available payload volume. The fairing interfaces with the launch vehicle at the fixed conical boattail that is attached to the launch vehicle first stage. Clearance losses for payloads are minimized by the Centaur Forward Load Reactor (CFLR) system that stabilizes the top of the Centaur, thereby reducing the relative motion between the PLF and payload. Figure 6.2-2 shows the 5-m PLF interface features. The PLF sections provide mounting provisions for various secondary systems. Electrical packages required for the PLF separation system are mounted on the internal surface of the fairing. PLF compartment cooling system provisions are in the ogive section of the fairing.

Figure 6.2-1: Atlas V 5-Meter Payload Fairing Configuration



AVUG11\_F0602\_01c

Figure 6.2-2: Atlas V 5-m Payload Fairing Interface Features



### 6.2.1 Atlas V 5-m Static Payload Envelope

The static payload envelope defines the useable volume for a spacecraft inside the PLF. The Atlas V 5-m PLF provides a 4,572-mm (180-in.) diameter envelope in the cylindrical section with additional volume available in the ogive section of the PLF. This envelope represents the maximum allowable spacecraft static dimensions (including manufacturing tolerances) relative to the spacecraft/payload adapter interface. Some increases in diameter may be allowed on a mission-unique basis, but must be analyzed. These envelopes were developed to ensure a minimum 25-mm (1-in.) clearance between the spacecraft and the PLF and to include allowances for PLF static tolerances and misalignments, spacecraft-to-PLF dynamic deflections, and PLF out-of-round conditions. They are also applicable for spacecraft that meet the stiffness and load requirements discussed in Section 3.2.1. Atlas V performs clearance layouts and analyses for each spacecraft configuration and, if necessary, measures critical clearance locations after the spacecraft is encapsulated inside the PLF to ensure positive clearance during flight. Figure 6-4 shows simplified views of the static payload envelope for the Atlas V 5-m short, medium, and long PLFs.

For customers who request a dynamic payload envelope, the static payload envelopes shown in Figure 6-4 can be conservatively used for preliminary design purposes. These envelopes meet the requirements for dynamic payload envelopes of the EELV SIS. The static payload envelopes were based on a combination of flight, jettison, and ground handling conditions, and the spacecraft dynamic deflections are only a consideration during flight conditions. Mission-unique modifications to these envelopes, either on a static or dynamic basis, depend on the spacecraft configuration and dynamic behavior of the spacecraft.

### 6.2.2 Payload Compartment Environmental Control

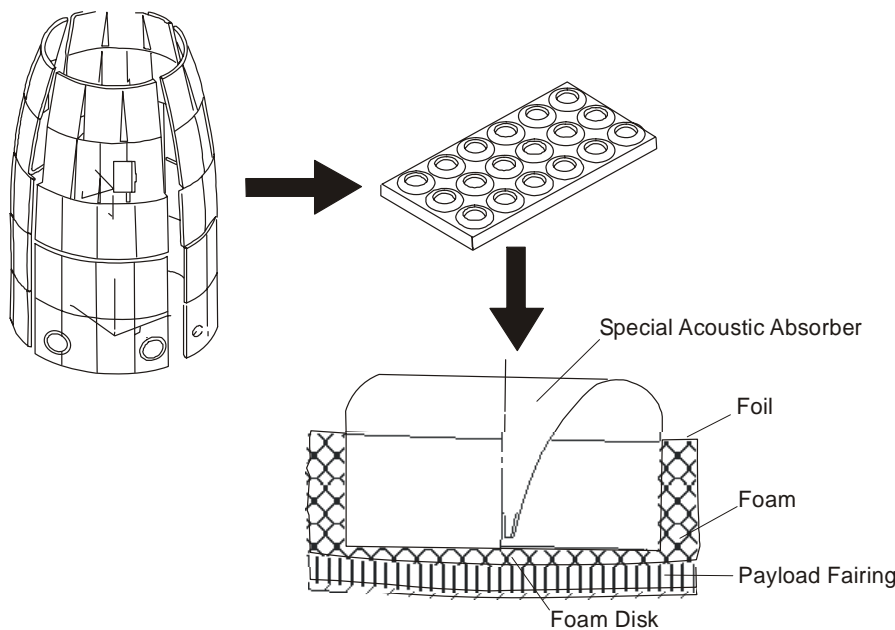
The Atlas V 5-m PLF provides a suitable acoustic, thermal, electromagnetic, and contamination-controlled environment for the payload. Atlas V provides the Fairing Acoustic Protection (FAP) in Figure 6.2.2-1 as a standard service to attenuate the sound pressure levels to acceptable limits (Section 3.2.2).

For thermal control, the external surface of the fairing is insulated with cork and painted white to limit temperatures to acceptable values as identified in Sections 3.1.1 and 3.2.5. The FAP panels also reduce heating in the payload compartment. During prelaunch activities, conditioned air is provided through the air-conditioning inlet located in the ogive section of the PLF. This inlet directs conditioned air to provide thermal and humidity control for the payload compartment and prevents direct impingement of this flow on the spacecraft. Vent ports and vent port assemblies are mounted in the mid-section of the base module for air from the air-conditioning system to exit the PLF and to allow depressurization during ascent. A secondary environmental control system may be added as a mission-unique option to provide additional cooling or to direct cooling air to specific points on the payload.

Electrically conductive paint is used on the outside of the PLF to prevent electrostatic build-up on the PLF.

Atlas fabricates and operates the PLF according to the requirements of the Atlas Contamination Control plan described in Section 3.1.3. This plan establishes rigorous procedures to ensure that all hardware that comes into close proximity with the payload meets cleanliness requirements and may be tailored to meet mission-unique payload requirements.

**Figure 6.2.2-1: Atlas V 5-m Fairing Acoustic Protection**



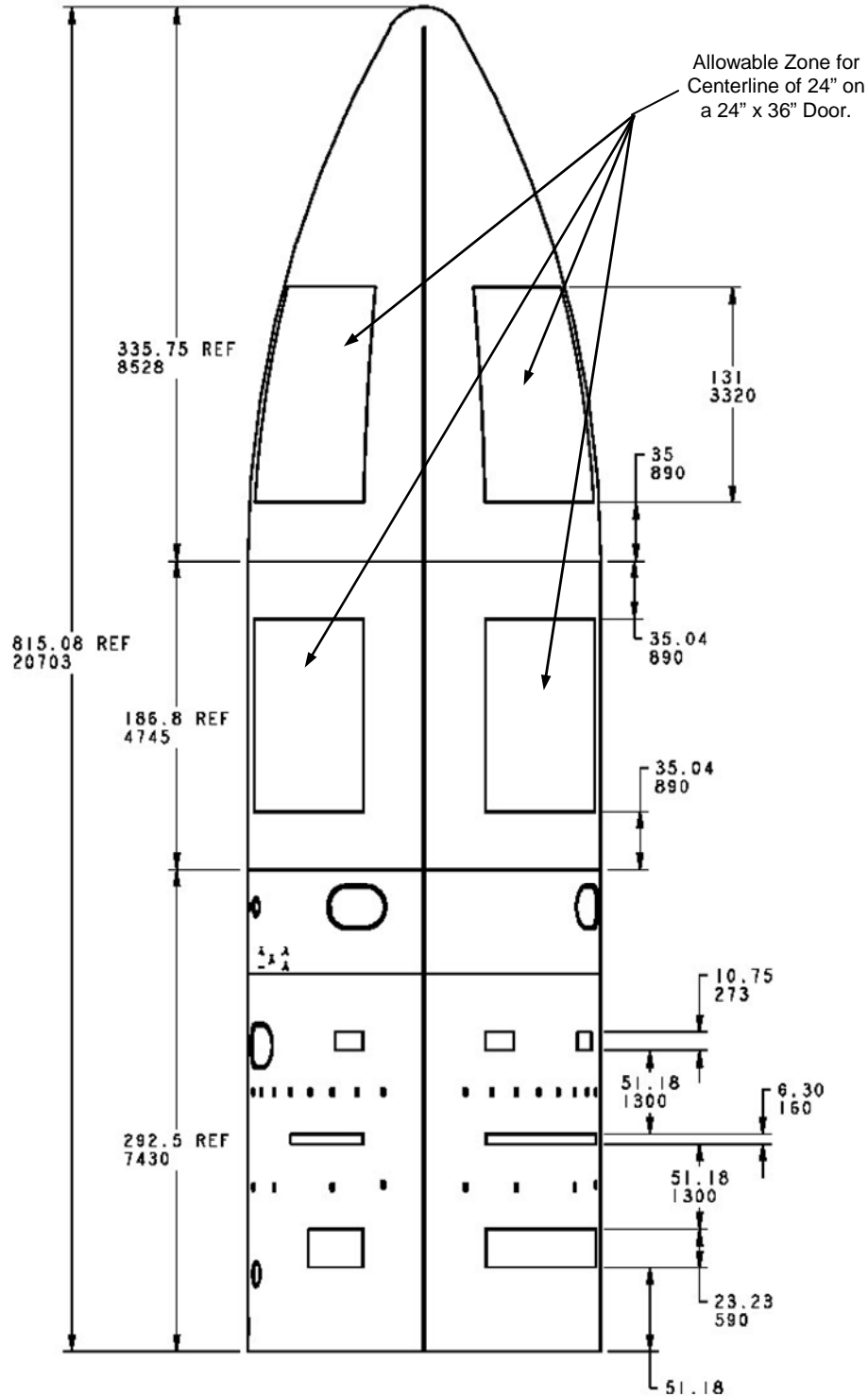
AVUG11\_F060202\_01a

### 6.2.3 5-m PLF Payload Access

The 5-m PLF has four large doors in the PLF base module to provide primary access to the Centaur forward adapter packages and the encapsulated spacecraft. The doors provide an opening of approximately 600 x 900 mm (24 x 36 in.). Work platforms can be inserted through these doors onto the CFLR deck to allow access to spacecraft hardware near the aft end of the payload module. If additional access to the spacecraft is required, additional doors can be provided on a mission-unique basis on the cylindrical and ogive section of the PLF. The available sizes and allowable locations for these mission-unique doors are shown in Figures 6.2.3-1 to 6.2.3-3. Access is permitted from the time of payload encapsulation until closeout operations prior to launch operations.



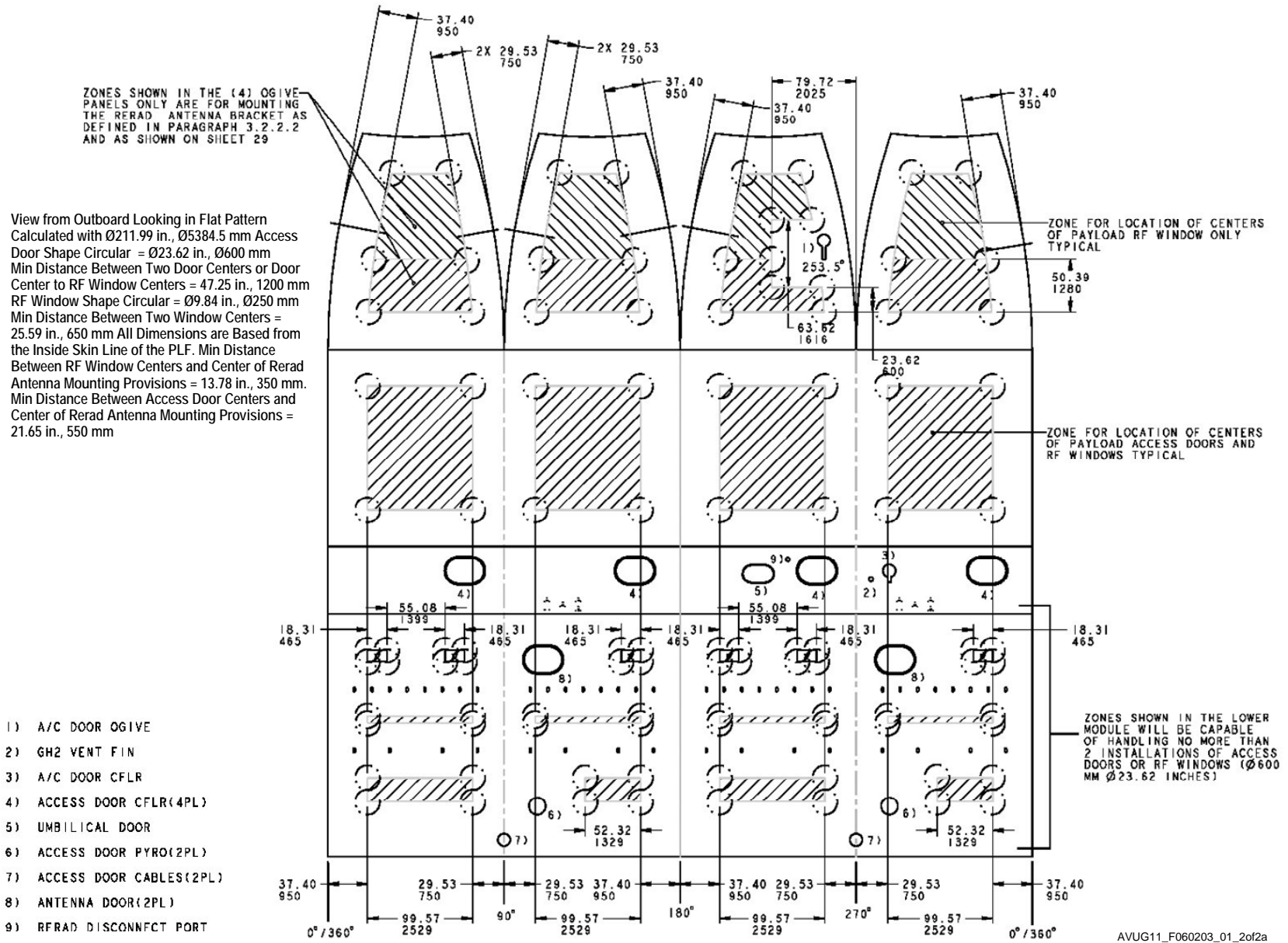
Figure 6.2.3-1: Atlas V 5-m Short PLF Mission Specific Access Door Allowable Locations (1 of 2)



68-Ft Payload Fairing  
(Short)

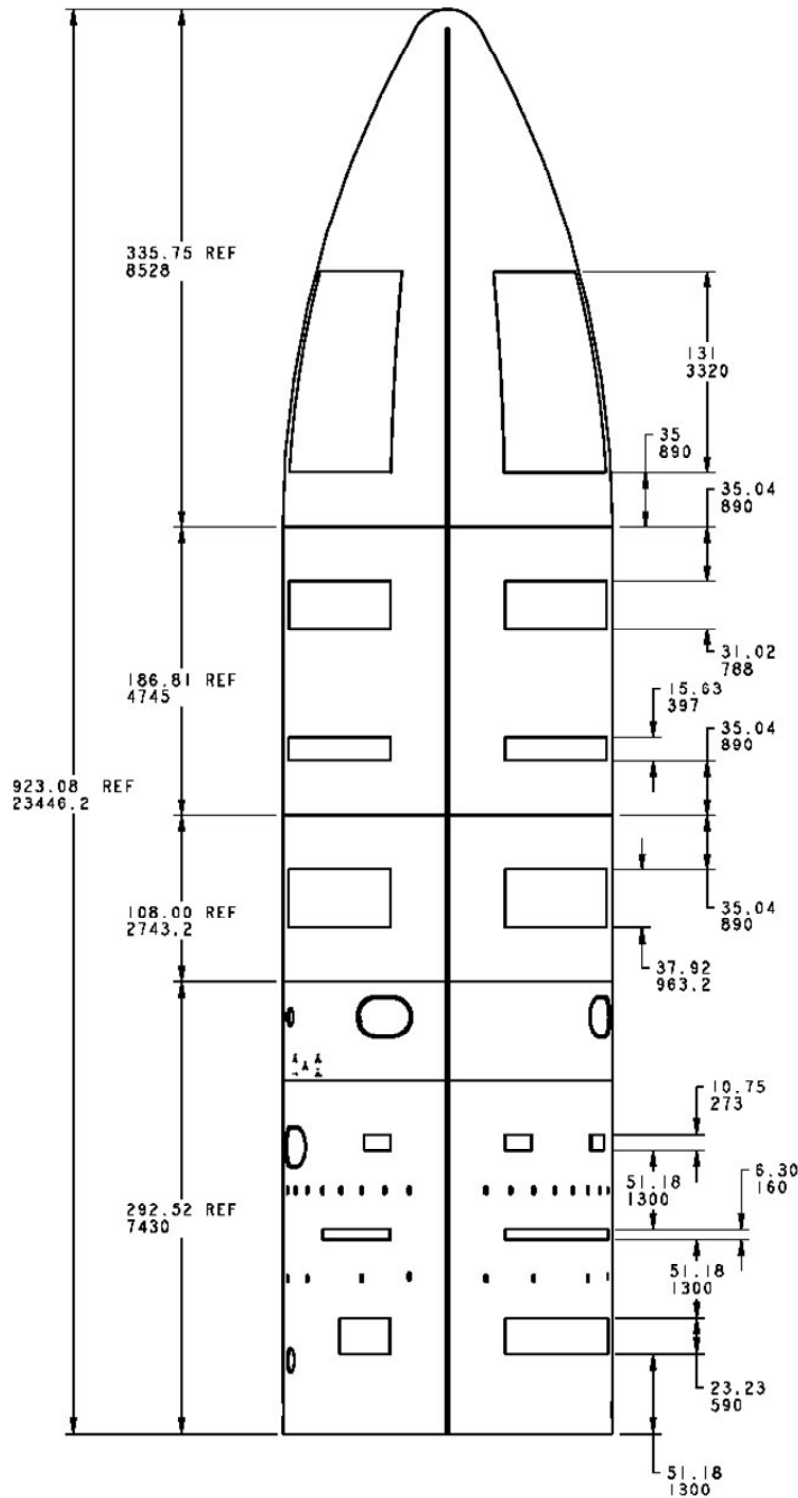
AVUG11\_F060203\_01\_1of2d

Figure 6.2.3-1: Atlas V 5-m Short PLF Mission Specific Access Door Allowable Locations (2 of 2)



AVUG11\_F060203\_01\_2of2a

Figure 6.2.3-2: Atlas V 5-m Medium PLF Mission Specific Access Door Allowable Locations (1 of 2)



77-Ft Payload Fairing  
(Medium)

AVUG11\_F060203\_02\_1of2d

Figure 6.2.3-2: Atlas V 5-m Medium PLF Mission Specific Access Door Allowable Locations (2 of 2)

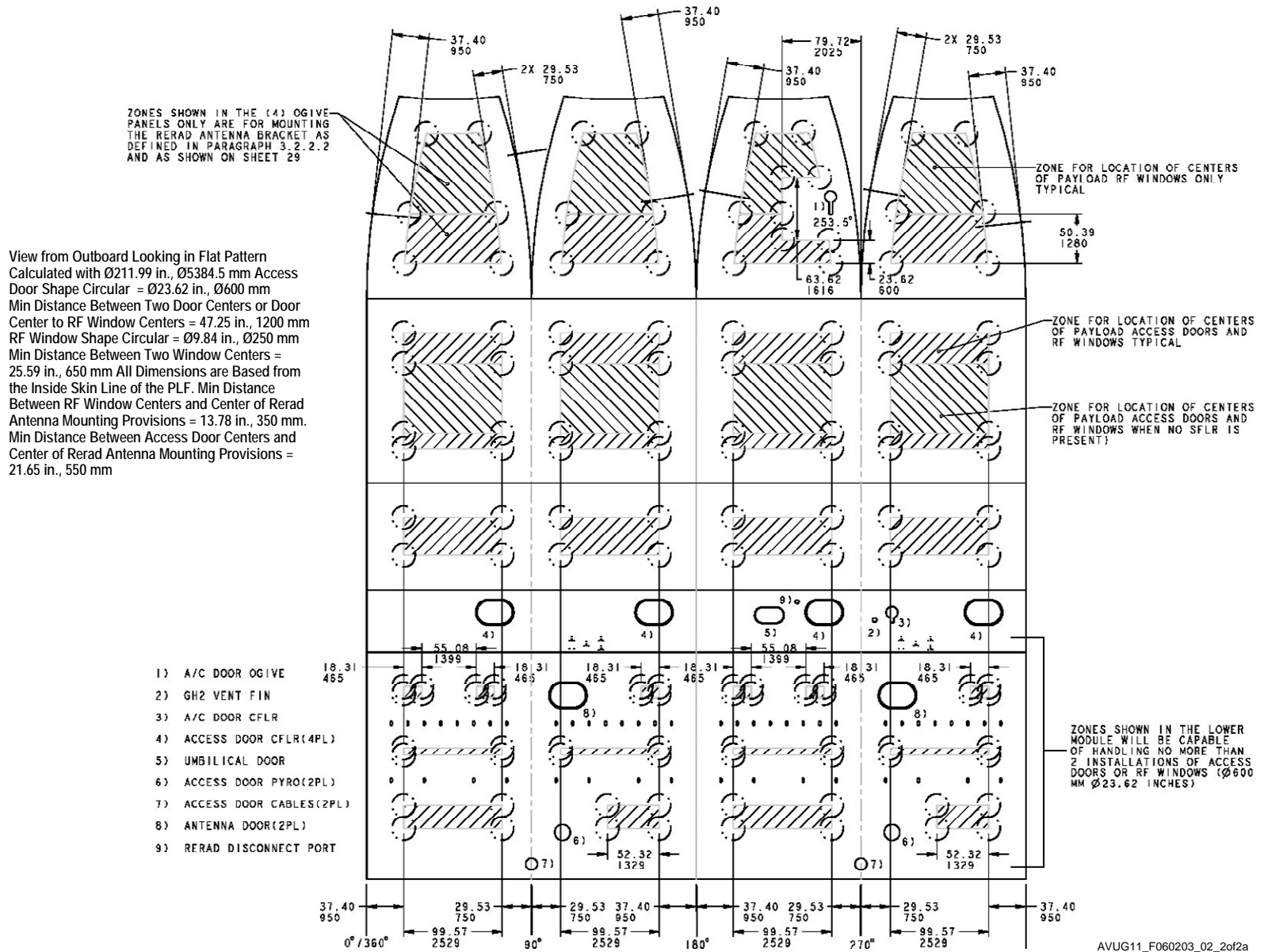
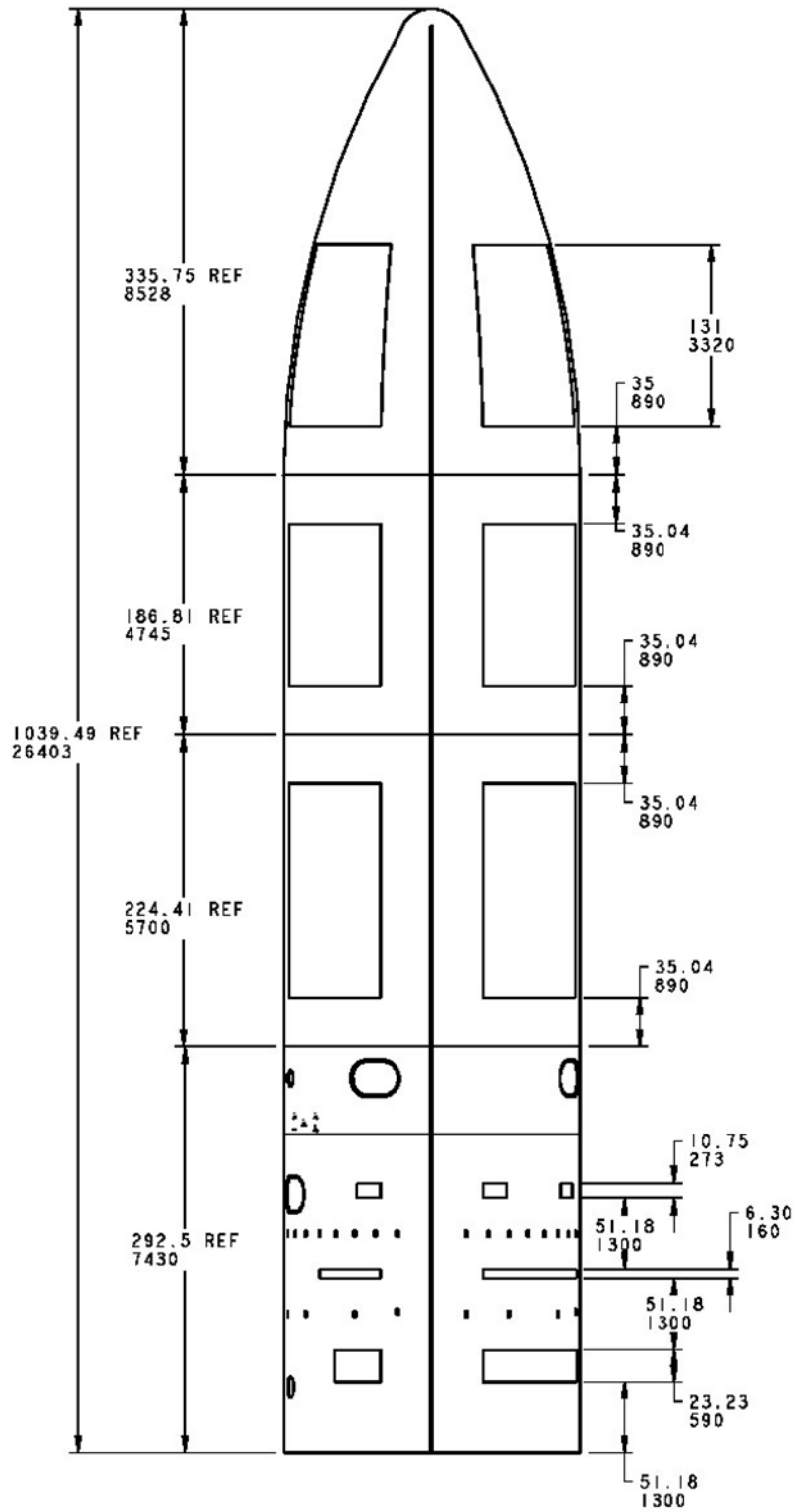


Figure 6.2.3-3: Atlas V 5-m Long PLF Mission Specific Access Door Allowable Locations (1 of 2)



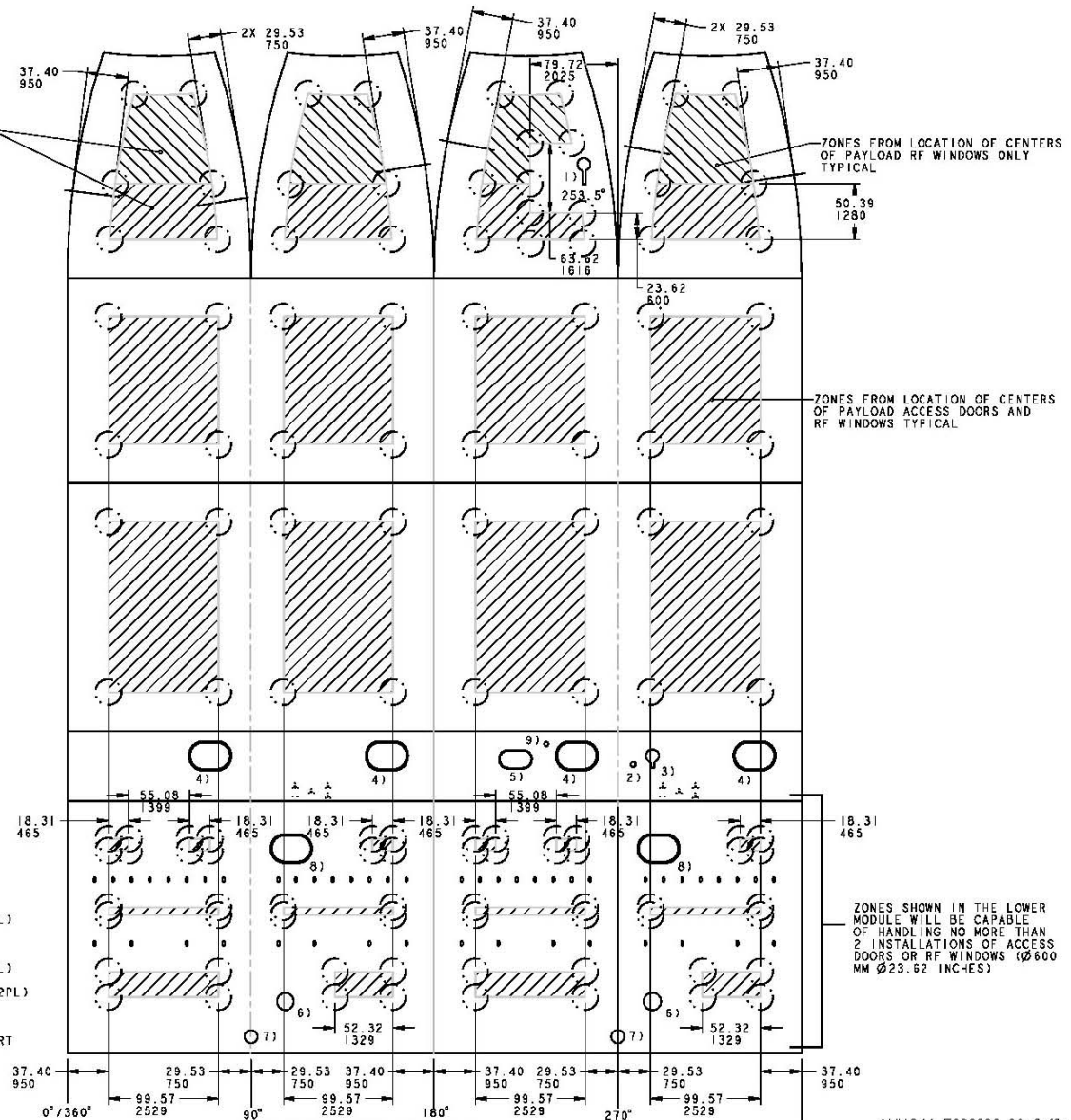
87-Ft Payload Fairing  
(Long)

AVUG11\_F060203\_03\_1of2d

Figure 6.2.3-3: Atlas V 5-m Long PLF Mission Specific Access Door Allowable Locations (2 of 2)

View from Outboard Looking in Flat Pattern  
 Calculated with  $\varnothing 211.99$  in.,  $\varnothing 5384.5$  mm Access  
 Door Shape Circular =  $\varnothing 23.62$  in.,  $\varnothing 600$  mm  
 Min Distance Between Two Door Centers or Door  
 Center to RF Window Centers = 47.25 in., 1200 mm  
 RF Window Shape Circular =  $\varnothing 9.84$  in.,  $\varnothing 250$  mm  
 Min Distance Between Two Window Centers =  
 25.59 in., 650 mm All Dimensions are Based from  
 the Inside Skin Line of the PLF. Min Distance  
 Between RF Window Centers & Center of Rerad  
 Antenna Mounting Provisions = 13.78 in., 350 mm.  
 Min Distance Between Access Door Centers and  
 Center of Rerad Antenna Mounting Provisions =  
 21.65 in., 550 mm

ZONES SHOWN IN THE (4) OGIVE  
 PANELS ONLY ARE FOR MOUNTING  
 THE RERAD ANTENNA BRACKET AS  
 DEFINED IN PARAGRAPH 5.2.2.2  
 AND AS SHOWN ON SHEET 29



- 1) A/C DOOR OGIVE
- 2) GH2 VENT FIN
- 3) A/C DOOR CFLR
- 4) ACCESS DOOR CFLR(4PL)
- 5) UMBILICAL DOOR
- 6) ACCESS DOOR PYRO(2PL)
- 7) ACCESS DOOR CABLES(2PL)
- 8) ANTENNA DOOR(2PL)
- 9) RERAD DISCONNECT PORT

AVUG11\_F060203\_03\_2of2a

### 6.2.4 Payload RF Communications

The composite 5-m PLF will provide some electromagnetic shadowing from external RF sources; however apertures and openings preclude it from being an effective RF shield, particularly at frequencies above 1 GHz.

A PLF reradiating system provides the capability for payload RF telemetry transmission and command receipt communications after payload encapsulation through the time of launch. The airborne system consists of an antenna, a mounting bracket, and cabling inside the PLF. Reradiating antennas are available as a mission-unique option in the S-band, C-band, and Ku-bands. The pickup antenna is mounted on a bracket at a location appropriate for the spacecraft configuration. This antenna acquires the spacecraft RF signal and routes it via RF cabling to the PLF T-0 disconnect. A cable runs from the T-0 disconnect to a junction box that routes the signal to a customer-specified location. Radiating RF inside an enclosed fairing produces an enhanced resonant environment that may be in excess of spacecraft or launch vehicle limits. An EMC analysis is performed to evaluate this condition early in the integration process.

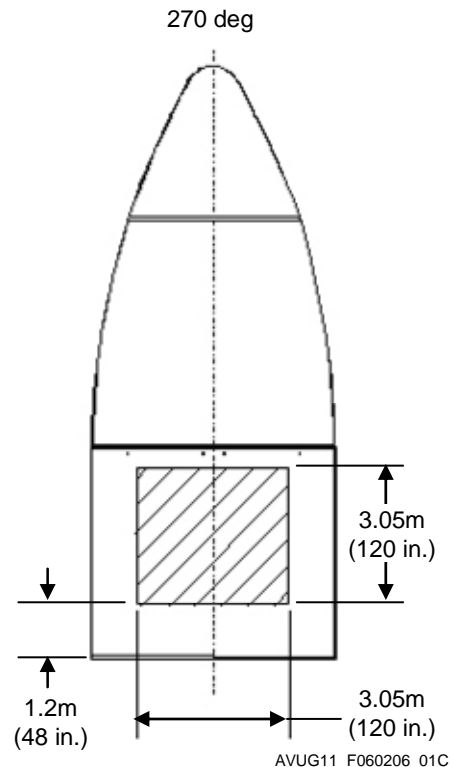
### 6.2.5 5-m PLF Shielding

The composite construction of the 5-meter fairing is not considered to provide any electromagnetic shielding for the spacecraft. Atlas assumes 0 dB of shielding for analysis purposes for standard 5-m PLF. Higher levels of shielding would require further investigation, development, and mission-unique modifications to the PLF.

### 6.2.6 Customer Logo

Customer-specified logos may be placed on the cylindrical section of the PLF. ULA provides logos up to 3.05 x 3.05 m (10 x 10 ft.) as a standard service. Figure 6.2.6-1 shows the area of the PLF reserved for customer logos. The ULA Customer Program Office works with customers and provides logo layouts on the launch vehicle to assist in determining proper size and location.

Figure 6.2.6-1: Atlas V 5-m Customer Logo Provisions



Intentionally Left Blank

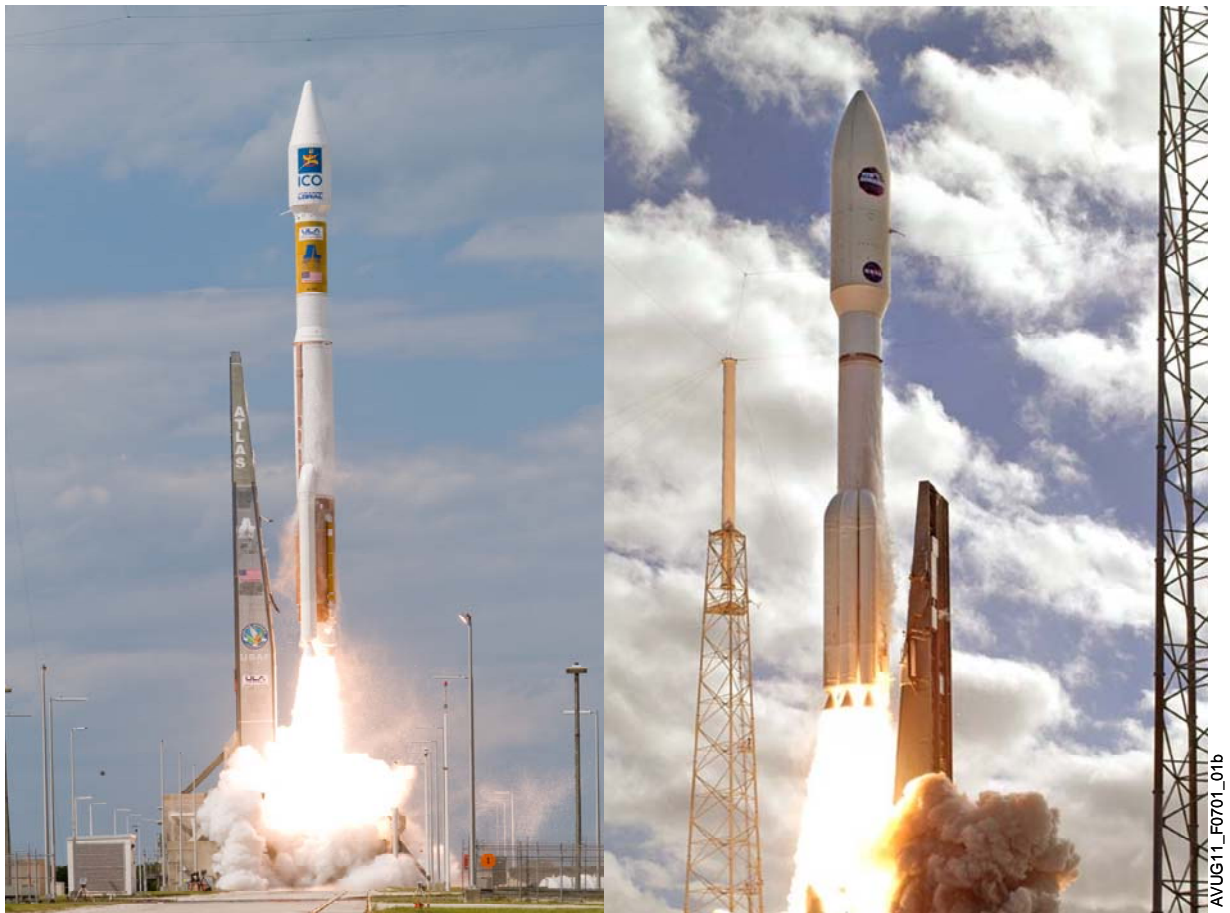


## 7. SPACECRAFT PROCESSING AND LAUNCH OPERATIONS

ULA has the capability to launch the Atlas V from facilities on both the East and West Coasts of the United States. Spacecraft (SC) requiring an equatorial or prograde orbit generally utilize the Eastern Range (ER) at Cape Canaveral Air Force Station (CCAFS) Florida, while polar and retrograde SC orbits use the Western Range (WR) at Vandenberg AFB California. Long-term use agreements with the United States Air Force (USAF) are in place for Space Launch Complex 41 (SLC-41) at CCAFS (Figure 7.1-1) and for Space Launch Complex 3E (SLC-3E) at VAFB (Figure 7.1-2) that encompass facilities, range services, and equipment.

This section summarizes launch facility capabilities available to Atlas V customers at CCAFS and VAFB.

Figure 7.1-1: Atlas V CCAFS Launches



Atlas 400 Series

Atlas 500 Series

AVUG11\_F0701\_01b

Figure 7.1-2: Atlas V VAFB Launch



## 7.1 CAPE CANAVERAL AIR FORCE STATION ATLAS V LAUNCH FACILITIES

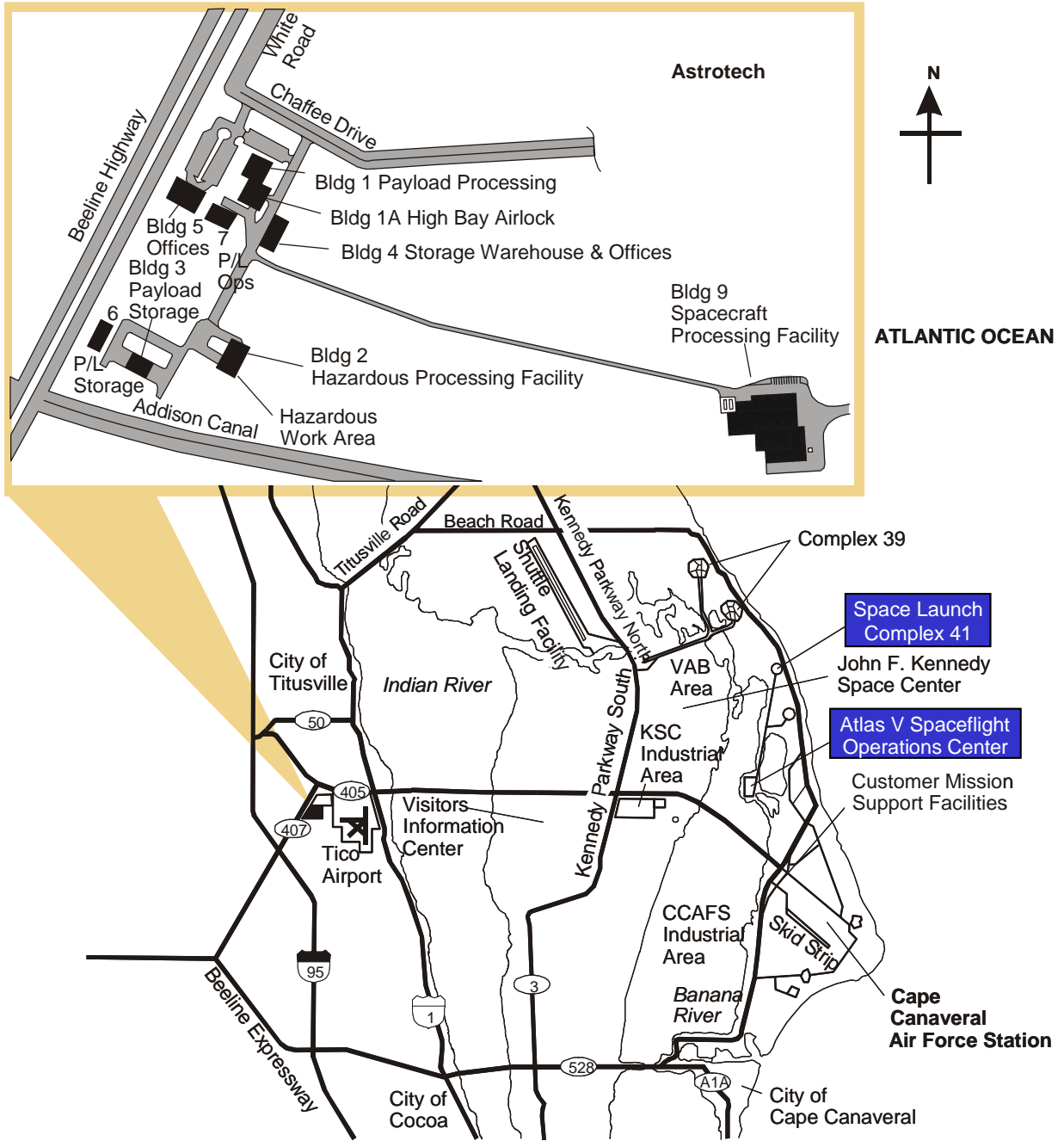
CCAFS facilities include SC processing facilities available to commercial and U.S. government users. Figure 7.1.1-1 identifies facility locations at or near CCAFS.

### 7.1.1 CCAFS Spacecraft Processing Facilities

CCAFS facilities include SC processing facilities available to commercial and U.S. government users. The Astrotech Payload Processing Facility (PPF), owned and operated by Spacehab Inc., is the primary facility for processing Atlas V class civil, government, and commercial SC. The following section describes the Astrotech SC processing and encapsulation facilities. Please visit the Astrotech website at [www.spacehab.com](http://www.spacehab.com) for the latest CCAFS Facilities Accommodations Manual.

**Astrotech Commercial Payload Processing Facility** — The Astrotech facility shown in Figure 7.1.1-2 contains nine major buildings identified as Buildings 1 through 9, and is divided into nonhazardous and hazardous work areas, storage buildings, and offices. Buildings 7 and 8 are not available for customer use. The following sections describe the facilities and floor plans. Astrotech complies fully with all applicable federal, state, regional, and local statutes, ordinances, rules, and regulations relating to safety and environmental requirements.

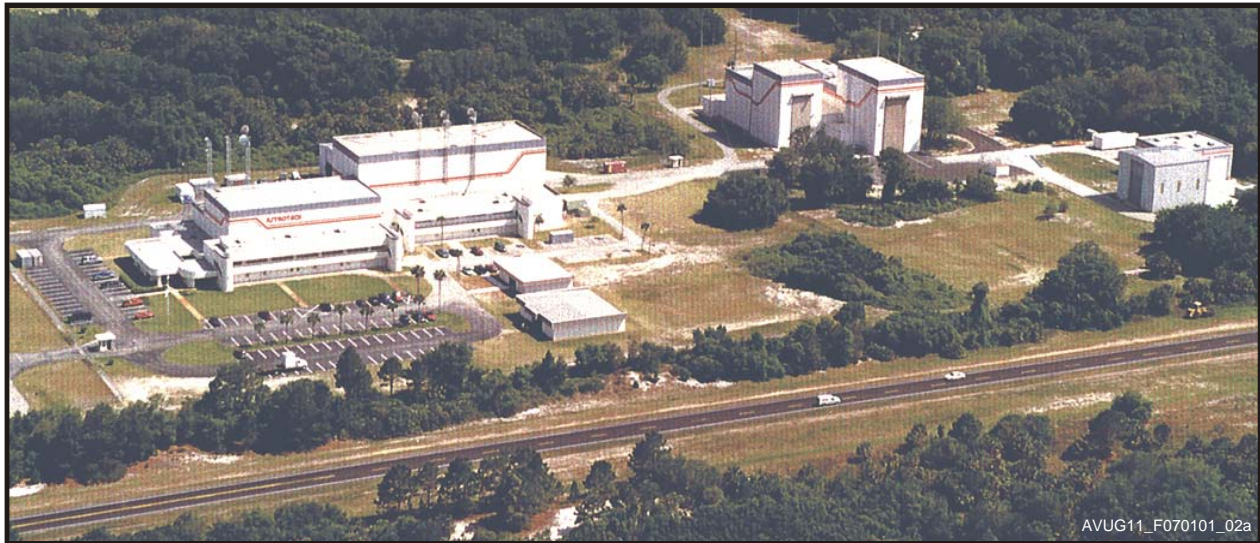
Figure 7.1.1-1: Facility Locations at or Near CCAFS



AVUG11\_F070101\_01c



Figure 7.1.1-2: Astrotech Facility



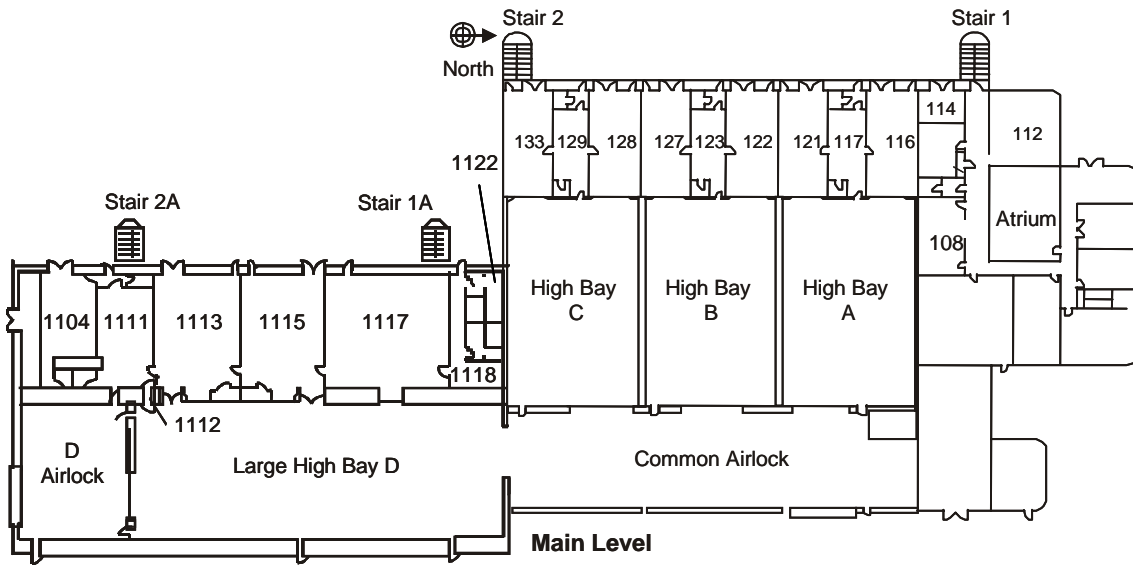
**Astrotech PPF** — Astrotech Building 1 (Figure 7.1.1-3) contains four high bay complexes with a supporting airlock. The PPF is used for nonhazardous SC operations, including final SC assembly and checkout. Transport to Building 2 or 9 for integrated activities is the responsibility of the SC contractor. Figures 7.1.1-4 depict Building 1's floor plan. Table 7.1.1-1 lists details of Building 1 facility room dimensions, cleanliness, and crane capabilities. With overall dimensions of approximately 61.0 m (200 ft) by 38.1 m (125 ft) and a height of 14 m (46 ft), the building's major features are:

1. An airlock
2. Four high bays (three identical and one larger)
3. Control rooms (two per high bay)
4. Office complex, administrative area, communications mezzanine, conference rooms, and support areas

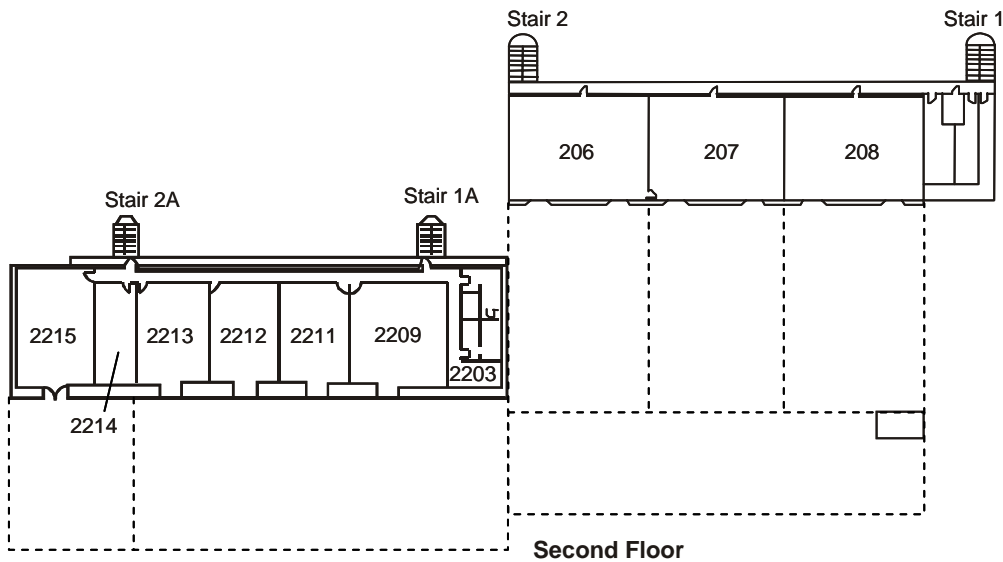
Figure 7.1.1-3: Astrotech Building 1



Figure 7.1.1-4: Astrotech Building 1 Detailed Floor Plan



Room	Function	Room	Function	Room	Function
108	Conference Room	123	Change Room B	1112	Air Shower
112	Break/Lunch Room	127	Control Room B2	1113	Control Room D2
114	Machine Shop	128	Control Room C1	1115	Control Room D1
116	Control Room A1	129	Change Room C	1117	Office Area
117	Control Room A	133	Control Room C2	1118	Break Room
121	Control Room A2	1104	Conference D1		
122	Control Room B1	1111	Change Room D		



Room	Function	Room	Function	Room	Function
206	Office Area C	2209	Office Area	2214	Office Area
207	Office Area B	2211	Office Area	2215	Office Area
208	Office Area A	2212	Office Area		
2203	Break Room	2213	Office Area		

AVUG11\_F070101\_04

**Table 7.1.1-1: Astrotech Building 1 Payload Processing Facility**

High Bays A, B, C (3) — Class 100,000 Clean Room			Large High Bay D — 100,000 Clean Room		
Temperature	23.8 ±2.8 °C*	75 ±5 °F*	Temperature	23.8 ±2.8 °C	75 ±5 °F
Relative Humidity	50 ±5%*		Relative Humidity	50 ±5%	
Usable Floor Space	18 x 12.19 m	60 x 40 ft	Usable Floor Space	38.1 x 15.5 m	125 x 51 ft
Ceiling Height	13.2 m	43.5 ft	Ceiling Height	18.3 m	60 ft
Crane Type (Each Bay)	Bridge		Crane Type (Each Bay)	Bridge	
Crane Capacity	9.07 tonne	10 ton	Crane Capacity <sup>1</sup>	27.21 tonne	30 ton
Crane Hook Height	11.3 m	37.1 ft	Crane Hook Height	15.2 m	50 ft
Roll-Up Door Size (w x h)	6.1 x 7 m	20 x 23 ft	High Bay Airlock Door Size (w x h)	6.1 x 15.2 m	20 x 50 ft
			Main Airlock Door Size (w x h)	6.1 x 7 m	20 x 23 ft
High Bay Control Rooms A, B, C (3)			Large Bay Control Rooms (2)		
Size	9.1 x 12.8 m	30 x 42 ft	Size	9.1 x 10.7 m	30 x 35 ft
Ceiling Height	2.67 m	8.75 ft	Ceiling Height	2.8 m	9.33 ft
Door Size (w x h)	2.44 x 2.44 m	8 x 8 ft	Door Size (w x h)	2.44 x 2.44 m	8 x 8 ft
Temperature	23.8 ±2.8 °C	75 ±5 °F	Temperature	23.8 ±2.8 °C	75 ±5 °F
Bay Window Size	1.22 x 2.44 m	4 x 8 ft			
Common Airlock: Class 100,000 Clean Room			Large Bay Airlock		
Temperature	23.8 ±2.8 °C*	75 ±5 °F*	Temperature	23.8 ±2.8 °C	75 ±5 °F
Relative Humidity	50 ±5%*		Relative Humidity	50 ±5%	
Usable Floor Space	36.6 x 9.14 m	120 x 30 ft	Usable Floor Space	12.2 x 15.5 m	40 x 51 ft
Ceiling Height	7.0 m	23 ft	Ceiling Height	18.3 m	60 ft
Door Size (w x h)	6.1 x 7 m	20 x 23 ft	Door Size (w x h)	6.1 x 15.2 m	20 x 50 ft
			Crane Hook Height	15.2 m	50 ft
			Crane Capacity <sup>1</sup>	27.21 tonne	30 ton
Offices: Second Floor			Offices: Second Floor		
Floor Size	12.5 x 7.3 m	41 x 24 ft	Floor Size (D1)	10.7 x 12.5 m	35 x 41 ft
Ceiling Height	2.43 m	8 ft	Floor Size (D2)	9.1 x 10.7 m	30 x 35 ft
Door Size (w x h)	0.91 x 2.04 m	3 x 6.7 ft	Floor Size (D3)	7.6 x 9.1 m	25 x 30 ft
Bay Window Size	1.22 x 1.22 m	4 x 4 ft	Ceiling Height	2.8 m	9.33 ft

<sup>1</sup>Building 1 D high bay and airlock crane capacity is 27.21 tonnes (30 tons). A 13.6-tonne (15-ton) hook is installed as standard, however the 27.2-tonne (30-ton) hook can be installed at the request of the customer. The crane is normally proof-tested for the 13.6-tonne (15-ton) hook only.

**Astrotech Hazardous Processing Facility** — Astrotech's Building 2 is a Hazardous Processing Facility (HPF) located within the controlled hazardous work area of the complex. This facility supports liquid propellant transfer operations, solid propellant rocket motor and ordnance preparations, dynamic balancing, and SC encapsulation operations. Table 7.1.1-2 lists the facility's room dimensions, cleanliness levels, and crane capabilities. With overall dimensions of approximately 48.5 m (159 ft) by 34.1 m (112 ft) and a height of 14 m (46 ft), the major features are:

1. An airlock
2. Two SC processing high bay and operations rooms
3. Two SC encapsulation high bays
4. One spin balance bay

Table 7.1.1-2: Astrotech Building 2 — Three Blast-Proof Processing Rooms

<b>North and South High Bay — Class 100,000 Clean Room</b>			<b>Airlock — Class 100,000 Clean Room</b>		
Temperature	23.9 ±2.8 °C*	75 ±5 °F*	Temperature	23.9±2.8 °C*	75±5 °F*
Relative Humidity	50 ±5%*		Relative Humidity	50 ±5%*	
Floor Space	18.3 x 11.3 m	60 x 37 ft	Floor Space	11.6 x 8.8 m	38 x 29 ft
Ceiling Height	13.1 m	43 ft	Ceiling Height	13.1 m	43 ft
Crane Type (Each Bay)	Bridge		Crane Type	Monorail	
Crane Capacity	9.1 tonne	10 ton	Crane Capacity	1.8 tonne	2 ton
Crane Hook Height	11.0 m	36.2 ft	Crane Hook Height	11.3 m	37 ft
Fuel Island	7.6 x 7.6 m	25 x 25 ft	South Encapsulation	6.1 x 12.2 m	20 x 40 ft
Spin Bay Door (w x h)	6.1 x 13.1 m	20 x 43 ft	Bay Door (w x h)		
North Encapsulation Bay & South Air Lock Doors (w x h)	6.1 x 12.2 m	20 x 40 ft	South High Bay Door (w x h)	6.1 x 12.2 m	20 x 40 ft
<b>North High Bay Control Room</b>			<b>North Encapsulation High Bay</b>		
			<b>Class 100,000 Clean Room</b>		
Temperature	21.1 to 23.9 °C	70 to 75 °F	Temperature	23.9±2.8 °C*	75±5 °F*
Floor Space	7.6 x 9.1 m	25 x 30 ft	Relative Humidity	50±5%*	
Ceiling Height	2.84 m	9.33 ft	Floor Space	15.2 x 12.2 m	50 x 40 ft
Outside Door (w x h)	2.4 x 2.4 m	8 x 8 ft	Fuel Island	7.6 x 7.6 m	25 x 25 ft
Bay Window (w x h)	0.81 x 0.76 m	2.67 x 2.50 ft	Ceiling Height	19.8 m	65 ft
<b>South High Bay Control Room</b>			<b>South Encapsulation High Bay</b>		
			<b>Class 100,000 Clean Room</b>		
Temperature	21.1 to 23.9 °C	70 to 75 °F	Crane Type	Bridge	
Floor Space	7.6 x 7.6 m	25 x 25 ft	Crane Capacity	27.2 tonne	30 ton
Ceiling Height	2.84 m	9.33 ft	Crane Hook Height	16.99 m	55.75 ft
Outside Door (w x h)	2.4 x 2.4 m	8x8 ft	Outside Door (w x h)	6.1x15.2 m	20 x 50 ft
Bay Window (w x h)	0.81 x 0.76 m	2.67 x 2.50 ft	North High Bay Door (w x h)	6.1x12.2 m	20 x 40 ft
<b>Spin Balance High Bay</b>			<b>South Encapsulation High Bay</b>		
			<b>Class 100,000 Clean Room</b>		
Temperature	23.9±2.8 °C*	75±5 °F*	Temperature	23.9 ±2.8 °C*	75 ±5 °F*
Relative Humidity	50±5%*		Relative Humidity	50 ±5%*	
Floor Space	14.6x8.2 m	48x27 ft	Floor Space	13.7 x 21.4 m	45 x 70 ft
Ceiling Height	13.1 m	43 ft	Ceiling Height	19.8 m	65 ft
Crane Type	Bridge		Crane Type	Bridge	
Crane Capacity	9.1 tonne	10 ton	Crane Capacity	27.2 tonne	30 ton
Crane Hook Height	11.0 m	36.2 ft	Crane Hook Height	17.1 m	56.7 ft
North & South High Bay Door (w x h)	6.1 x 13.1 m	20 x 43 ft	Outside Door (w x h)	7.0 x 16.8 m	23 x 55 ft
			South Airlock Door (w x h)	6.1 x 12.2 m	20 x 40 ft
<b>Spin Balance High Bay Control Room</b>			<b>Propellant (Oxidizer &amp; Fuel) Cart Rooms (2)</b>		
Temperature	23.9 ±2.8 °C	75 ±5 °F	Floor Space	6.1 x 6.1 m	20 x 20 ft
Floor Space	3 x 4.6 m	10 x 15 ft	Ceiling Height	2.84m	9.33 ft
Ceiling Height	2.84 m	9.33 ft	South High Bay Door	3.1 x 2.4 m	10 x 8 ft
South Control Room Door (w x h)	1.8 x 2.03 m	6 x 6.67 ft	Outside Door (w x h)	1.8 x 2.03 m	6 x 6.67 ft
* Can be Adjusted as Needed					

Figure 7.1.1-5 depicts the Building 2 floor plan. Each high bay is built to explosion-proof or equivalent standards to support operations involving liquid propellant transfer, solid propellant motor preparations, and ordnance installation.

Figure 7.1.1-5: Astrotech Building 2 Hazardous Operations Facility



AVUG11\_F070101\_05a

**Astrotech Spacecraft Support Facilities** — Building 3 at Astrotech is a thermally controlled, short-term SC storage area supporting SC processing activities. Table 7.1.1-3 identifies storage bay and door dimensions and thermal control ranges.

Astrotech's Building 4 is a warehouse storage area without environmental controls and is suitable for storage of shipping containers and mechanical Ground Support Equipment (GSE). Table 7.1.1-4 details this facility's dimensions.

Astrotech's Building 5 provides 334.4 m<sup>2</sup> (3,600 ft<sup>2</sup>) of customer office space divided into 17 offices with a reception area sufficient to accommodate up to three administrative assistants.



Astrotech's Building 6 provides storage primarily for ULA PLF support equipment. However, if customers require additional non-environmentally controlled storage, this additional space can be made available.

**Table 7.1.1-3: Astrotech Building 3 — Short Term Spacecraft Storage**

Building 3: Thermally Controlled Storage Facility		
Temperature Control	25.6 °C	70 to 78 °F
Relative Humidity	50±10%	
Height (All Bays)	8.5 m	28 ft
Floor Space		
• Bays A, C, D & F	7.6 x 6.7 m	25 x 22 ft
• Bays B & E	7.6 x 7.3 m	25 x 24 ft
Door Size (w x h)		
• Bays A, C, D & F	6.1x7.6 m	20x25 ft
• Bays B & E	5.5x7.6 m	18x25 ft
Crane	None	

**Table 7.1.1-4: Astrotech Building 4 — Warehouse Storage Area**

Building 4: Storage without Environmental Control		
Floor Space	15.2x38.1 m	50x125 ft
Height	8.5 m	28 ft
Door Size	6.1x7.9 m	20x26 ft
Crane	None	

**Spacecraft Services** — Astrotech can provide full services for SC processing and integration.

**Electrical Power and Lighting** — The Astrotech facility is served by 480-VAC/three-phase commercial 60- and 50-Hz electrical power that can be redistributed as 480-VAC/three-phase/30-A, 120/208-VAC/three-phase/60-A, or 120-VAC/single-phase, 20-A power to any location in Buildings 1 and 2. A diesel generator provides backup to commercial power during critical testing and launch periods. Astrotech can provide 35 kW of 230/380-VAC/three-phase 50-Hz power, which is also backed up by a diesel generator.

The high bays and airlocks in Buildings 1 and 2 are lighted by 400-W metal halide lamps to maintain 100 fc of illumination. Control rooms, offices, and conference areas have 35-W fluorescent lamps to maintain a minimum 70 fc of illumination.

**Telephone and Facsimile** — Astrotech provides telephone equipment, local telephone service, and long distance access. A Group 3 facsimile machine is also available.

**Intercommunication Systems** — Astrotech provides a minimum of three channels of voice communications among all work areas. The facility is connected to the NASA/USAF Operational Intercommunications System (OIS) and Transistorized Operational Phone System (TOPS) to provide multiple-channel voice communications between the Astrotech facility and selected locations at CCAFS.

**Closed-Circuit Television** — Closed-Circuit Television (CCTV) cameras are located in the high bays of Building 2 and can be placed in the high bays of Building 1, as required, to permit viewing operations in those areas. CCTV can be distributed within the Astrotech facility to any location desired. In addition, Astrotech has the capability to transmit and receive a single channel of video to and from Kennedy Space Center (KSC)/CCAFS via a dedicated microwave link.

**Command and Data Links** — Astrotech provides wideband and narrowband data transmission capability and the KSC/CCAFS cable transmission system to all locations served by the KSC/CCAFS network. If a SC requires a hard-line transmission capability, the SC is responsible for providing correct signal characteristics to interface to the KSC/CCAFS cable transmission system.

Astrotech provides antennas for direct S-band, C-band, and Ku-band airlinks from the Astrotech facility to SLC-41 and antennas for S-band, C-band, and Ku-band airlinks between Astrotech Buildings 1 and 2. There is also a ground connection between the PPF and HPF for hard-line Radio Frequency (RF) transmissions up to Ku-band.

**Customer Local Area Network** — Astrotech provides customer assistance for connectivity into an existing Local Area Network (LAN) that has drops available in the PPF and HPF. System interface is via standard RJ 45 connectors. End-item instruments, such as hubs, are customer provided. A limited number of drops on this system are available at the Launch Services Buildings (LSB). If the customer has arranged for a T1 line from an outside provider for LAN connectivity to their home facilities, Astrotech will ensure it is properly connected to the customer's PPF control room. Customers are responsible for verifying connectivity of the T1 line from the Astrotech facility back to their own facility.

**Remote Spacecraft Control Center** — Astrotech has the capability to link remote ground stations (voice and data) between Astrotech and CCAFS resources.

**Temperature and Humidity Control** — The environment of all Astrotech high bays and airlocks is maintained at a temperature of  $24 \pm 2.8$  °C ( $75 \pm 5$  °F) and a relative humidity of  $50 \pm 5\%$ . The environment of all other areas is maintained by conditioned air at a temperature between 21 and 25 °C (70 to 78 °F) and a comfortable humidity.

**Compressed Air** — Regulated compressed air at 125 psi is available in Buildings 1 and 2.

**Security and Emergency Support** — Perimeter security is provided 24 hours a day. Access to the Astrotech facility is via the main gate, where a guard is posted during working hours to control access. Cypher locks on all doors leading into SC processing areas provide internal security. Brevard County provides emergency medical support and the City of Titusville provides emergency fire support. In the event of an accident, personnel will be transported to Jess Parish Hospital in Titusville. NASA has trained both medical and fire personnel.

**Foreign Trade Zone** — Astrotech has been designated a foreign trade zone. Astrotech coordinates all licensing requirements to meet governmental regulations for importing and exporting support hardware for the duration of mission support.

**Electromagnetic Interference Control** — While the Astrotech building structures may provide some electromagnetic shadowing capability, doors and windows preclude it from being considered an effective EMI shield. EMI shielding attenuation values have not been quantified.

**Astrotech Spacecraft Processing Facility** — Astrotech's Building 9 Spacecraft Processing Facility (SPF) provides an additional HPF. This facility is capable of processing the full range of Atlas Payload Fairing (PLF) configurations from the 4-m Large Payload Fairing (LPF), Extended Payload Fairing (EPF), Extra EPF (XEPF), and the larger Atlas V 5-m PLF. Final preparations of the SC and the PLF take place in the SPF in a similar manner to those in the HPF. Table 7.1.1-5 lists the facility's room dimensions, cleanliness levels, and crane capabilities. Major areas of the SPF are:

1. One airlock
2. One encapsulation bay
3. Two high bays
4. Two propellant cart storage rooms
5. Two garment change rooms
6. Three control rooms

Figure 7.1.1-6 depicts the Building 9 floor plan. Each processing cell is built to explosion-proof or equivalent standards to support operations involving liquid propellant transfer, solid propellant motor preparations, and ordnance installation.

Figure 7.1.1-6: Astrotech Building 9 Layout

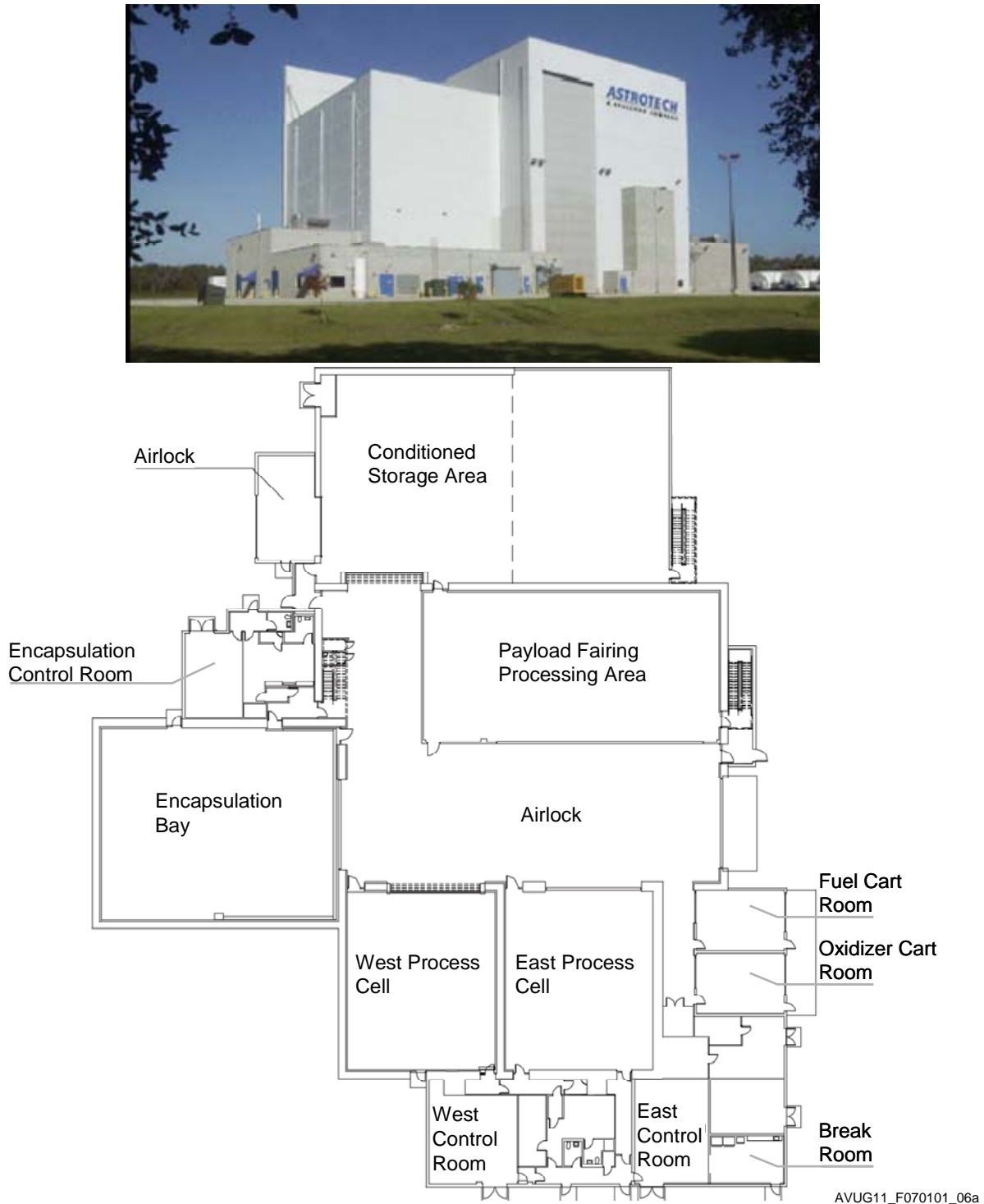


Table 7.1.1-5: Astrotech Building 9 — Two Processing Rooms

Airlock — Class 100,000 Clean Room			Encapsulation Bay — Class 100,000 Clean Room		
Temperature	23.9±2.8 °C*	75 ±5 °F*	Temperature	23.9±2.8 °C*	75 ±5 °F*
Relative Humidity	50 ±5%*		Relative Humidity	50±5%*	
Floor Space	38.7x30.2 m	127 x 99 ft	Floor Space	24.4x19.8 m	80 x 65 ft
Ceiling Height	30.8 m	101 ft	Ceiling Height	33.5 m	110 ft
Crane	Bridge/Trolley		Crane Type	Bridge/Trolley	
Crane Capacity	27.15 tonne	30 ton	Crane Capacity	45.25 tonne	50 ton
Crane Hook Height	27.7 m	91 ft	Crane Hook Height	30.5 m	100 ft
Encapsulation Bay Door (w x h)	9.1 x 27.7 m	30 x 91 ft	<b>Encapsulation Control Room</b>		
East/West High Bays Doors	9.1 x 19.8 m	30 x 65 ft	Temperature	21.1-23.9 °C	70-75 °F
(w x h)			Floor Space	8.5 x 5.8 m	28 x 19 ft
Outside Door (w x h)	9.1 x 27.7 m	30 x 91 ft	Ceiling Height	3.2 m	10.5 ft
Fairing Process Room Door (w x h)	21.3 x 7.6 m	70 x 25 ft	Door for EGSE Installation (w x h)	2.4 x 3.0 m	8 x 10 ft
Fairing Cnd Storage Door	7.6 x 19.8 m	25 x 65 ft	Access Door (w x h)	0.9 x 2.1 m	3 x 7 ft
(w x h)					
East High Bay — Class 100,000 Clean Room			Encapsulation Bay Garment Change Room		
Temperature	23.9±2.8 °C*	75 ±5 °F*	Floor Space	5.2 x 7.3 m	17 x 24 ft
Relative Humidity	50 ±5%*		Ceiling Height	2.7 m	9 ft
Floor Space	18.3x15.2 m	60 x 50 ft	<b>Fairing Processing Area</b>		
Ceiling Height	24.4 m	80 ft	Floor Space	30.8x15.7 m	101x51.5 ft
Access Door (w x h)	0.9 x 2.1 m	3 x 7 ft	Ceiling Height	9.1 m	30 ft
Crane Type (Each Bay)	Bridge/Trolley		<b>Conditioned Storage Area</b>		
Crane Capacity	22.67 tonne	25 ton	Floor Space	30.8x15.7 m	101x51.5 ft
Crane Hook Height	22.3 m	73 ft	Ceiling Height	19.8&6.1 m	65 & 20 ft
East High Bay Control Room			Conditioned Storage Airlock		
Temperature	21.1-23.9 °C	70-75 °F	Floor Space	11.6 x 9.1 m	38 x 30 ft
Floor Space	10.7 x 7.6 m	35 x 25 ft	Ceiling Height	11.6 m	11.6 m
Ceiling Height	3.2 m	10.5 ft	Outside Door (w x h)	6.1 x 9.1 m	20 x 30 ft
Door for EGSE Installation (wxh)	2.4 x 3.0 m	8 x 10 ft	Airlock Door (w x h)	6.1 x 9.1 m	20 x 30 ft
Access Door (w x h)	0.9 x 2.1 m	3 x 7 ft	Crane Capacity	13.6 tonne	15 ton
			Crane Hook Height	9.1 m	30 ft
West High Bay — Class 100,000 Clean Room			Propellant (Oxidizer & Fuel) Cart Rooms (2)		
Temperature	23.9±2.8 °C*	75 ±5 °F*	Floor Space	6.7 x 4.4 m	22 x 14.5 ft
Relative Humidity	50 ±5%*		Height	2.7 m	9 ft
Floor Space	18.3x15.2 m	60 x 50 ft	Airlock Door (w x h)	3.05 x 3.0m	10 x 10 ft
Ceiling Height	24.4 m	80 ft	Outside Door (w x h)	3.7 x 3.0 m	12 x 10 ft
Access Door (w x h)	0.9 x 2.1 m	3 x 7 ft	Floor Space	6.7 x 4.4 m	22 x 14.5 ft
Crane Type (Each Bay)	Bridge/Trolley		Height	2.7 m	9 ft
Crane Capacity	27.21 tonne	30 ton			
Crane Hook Height	22.3 m	73 ft			
West High Bay Control Room			Break Room		
Temperature	21.1-23.9 °C	70-75 °F	Floor Space	7.6 x 5.2 m	25 x 17 ft
Floor Space	9.3 x 9.3 m	30.5 x 30.5 ft	Ceiling Height	2.7 m	9 ft
Ceiling Height	3.2 m	10.5 ft			
Door for EGSE Installation (wxh)	2.4 x 3.0 m	8 x 10 ft			
Access Door (w x h)	0.9 x 2.1 m	3 x 7 ft			

\*Can be Adjusted as Needed

### 7.1.2 Encapsulated Spacecraft Transport to SLC-41

There are two transporters used to transport the encapsulated SC from Buildings 2 or 9 to the launch complex. The 5-m PLF configuration is transported on the KAMAG, the 4 meter square tube torus configuration is transported on either the KAMAG or the Lufkin Trailer, and the round tube torus configuration is transported on the Lufkin Trailer. Both transporters are equipped with an In Transport Payload Air Conditioning (ITPAC) Environmental Control System (ECS) and a Gaseous Nitrogen supply. The ECS is considered the primary system and the convoy will not leave the SPF or HPF if the ECS is not functioning. The GN<sub>2</sub> is used as a backup in case there is a failure of the ECS and to provide purges if required. The ECS system will provide positive pressure, humidity, and temperature control where the GN<sub>2</sub> system will provide a positive pressure and humidity control. The transport is performed at night when temperatures are within SC parameters and there is no solar heating of the PLF. Instrumentation is used during transport to monitor shock, temperature, and relative humidity within the PLF.

### 7.1.3 CCAFS Atlas V Launch Site Facilities

Atlas V uses three primary facilities with integrated GSE that support SC processing in addition to the encapsulation facilities identified in Section 7.1.1. The following section describes SLC-41 consisting of the Vertical Integration Facility, Payload Van, the Mobile Launch Platform, the launch pad and the Atlas Spaceflight Operations Center.

#### 7.1.3.1 Vertical Integration Facility

The Vertical Integration Facility (VIF) is a weather-enclosed steel structure, approximately 22.9 m (75 ft) square and 87.2 m (286 ft) tall, with metal doors, a hammerhead bridge crane, platforms, and servicing provisions required for LV integration and checkout (Figure 7.1.3.1-1). LV processing in the VIF includes stacking booster(s) and Centaur, performing LV subsystem checks and system verification, installing the encapsulated SC, performing integrated system verification, final installations, and vehicle closeouts.

Figure 7.1.3.1-1: Vertical Integration Facility



No provisions for SC propellant loading are available at the launch complex, either on-pad or in the VIF. The SC is fueled at the PPF before encapsulation. If required, emergency SC detanking on the launch complex will occur in the VIF.

The facility includes two stairways and one freight elevator for access to the platforms. Elevator capacity is 1,820 kg (4,000 lb), with maximum cargo dimensions of 1.7 m (5 ft, 7 in.) width, 2.4 m (7 ft, 9 in.) length, and 2.1 m (7 ft) height.

Access to the SC through the PLF access doors occurs on VIF Levels 5 to 7, depending on the LV and SC configuration. Access to the SC, if required, is provided using portable access stands. Class 5,000 conditioned air and localized Gaseous Nitrogen (GN<sub>2</sub>) purges (if required) are provided to the PLF to maintain the SC environment. SC conditioned air cleanliness, temperature, humidity, and flow rate are as follows:

1. Cleanliness Class 5,000
2. Temperature 10-29 °C (50-85 °F), selectable with tolerance ±2.8 °C (±5 °F)

3. Relative humidity 20-50%, maximum dewpoint 4.4 °C (40 °F) and 35-50% when required for sensitive operations
4. Flow rate: 0.38-1.21 kg/s (50-160 lb/min) selectable with tolerance  $\pm 0.038$  kg/s ( $\pm 5$  lb/min) (400 series), 0.38-2.27 kg/s (50-300 lb/min) selectable with tolerance 0.095 kg/s ( $\pm 12.5$  lb/min) (500 series)

Accommodations for SC personnel and test equipment are provided on VIF Levels 5, 6, 6.5, and 7. Table 7.1.3.1-1 identifies power, commodities, and communications interfaces on these levels. SC customers are encouraged to contact the ULA representative listed in the Preface to this guide for further details and capabilities.

The 54,000-kg (60-ton) facility crane used for lifting and mating the encapsulated SC has creep speed controls down to 30 mm/min (1.2 in/min) on the bridge and trolley, and 12.5 mm/min (0.5 in/min) on hoist, with maximum acceleration/deceleration of 75 mm/s<sup>2</sup> (0.25 ft/s<sup>2</sup>).

Critical power (redundant facility power) and facility power (120 V) are provided to support SC operations in the VIF. Communications on SC access levels in the VIF include unsecure operational voice system, telephone, public address and user interfaces. Lighting of up to 50 foot candles (fc) is provided on SC access levels in the VIF. If it should be necessary to perform an emergency SC propellant detank, the VIF includes fuel and oxidizer drains and vent lines, emergency propellant catch tanks, hazardous vapor exhaust, and breathing air support. Emergency propellant catch tanks and hazardous vapor exhaust scrubbers are provided in accordance with a Propellant Leak Contingency Plan (PLCP).

**Table 7.1.3.1-1: Vertical Integration Facility Spacecraft Accommodations**

Accommodation	Description	Qty
<b>VIF Level 5 (Spacecraft Mate)</b>		
Critical Power	120V, 20A, 60 Hz, 1Ø, 3W, 2P, Explosion Proof	3
	120/208V, 30A, 60 Hz, 3Ø, 5W, 4P, Explosion Proof	1
	120/208V, 60A, 60 Hz, 3Ø, 5W, 4P, Explosion Proof	1
Shop Air Outlets	GN <sub>2</sub> Service	2
Fuel & Oxidizer Lines	Emergency Propellant Detanking	1 Set
Customer Work Area	Desk/Phone/User Interface	2
User Interface	Hazardous, Fiber Optic	2
Telephone		7
Facility Ground Plate		2
Technical Ground Plate		3
<b>VIF Level 6 (Spacecraft Access Through PLF Doors)</b>		
Critical Power	120V, 20A, 60 Hz, 1Ø, 3W, 2P, Explosion Proof	2
Shop Air Outlets	GN <sub>2</sub> Service	2
Fuel & Oxidizer Lines	Emergency Propellant Detanking	1 Set
Customer Work Area	Desk/Phone/User Interface	2
User Interface	1 Each Nonhazardous, 2 Each Hazardous, Fiber Optic	3
Telephone		7
Facility Ground Plate		2
Technical Ground Plate		2
<b>VIF Level 7 (Access to Top of PLF)</b>		
Critical Power	120V, 20A, 60 Hz, 1Ø, 3W, 2P, Explosion Proof	4
Shop Air Outlets	GN <sub>2</sub> Service	2
Fuel & Oxidizer Lines	Emergency Propellant Detanking	1 Set
Customer Work Area	Desk/Phone/User Interface	2
User Interface	2 Each Nonhazardous, 2 Each Hazardous, Fiber Optic	4
Telephone		6

**Table 7.1.3.1-1: Vertical Integration Facility Spacecraft Accommodations (Continued)**

Accommodation	Description	Qty
Facility Ground Plate		3
Technical Ground Plate		3
<b>Freight Elevator</b>		
Size	Length x Width: 2,438.4 mm x 1,828.8 mm (8 ft x 6 ft)	
Door Clearance	Width x Height: 1,828.8 mm x 2,133.6 mm (6 ft x 6 ft 11 in.)	
Capacity	2,267.9 kg (5,000 lb)	

**7.1.3.2 Payload Support Van**

The Payload Support Van (PVan) provides electrical, gas, and communication interfaces between the SC ground support equipment and the SC, initially at the VIF for prelaunch testing, and subsequently at the pad during launch. The PVan, shown in Figure 7.1.3.2-1, consists of a rail car undercarriage and support container that houses the SC ground support equipment. The PVan provides approximately 23.2 m<sup>2</sup> (250 ft<sup>2</sup>) of floor space for SC mechanical, electrical, and support equipment. The PVan also provides power, air conditioning, lighting, and environmental protection.

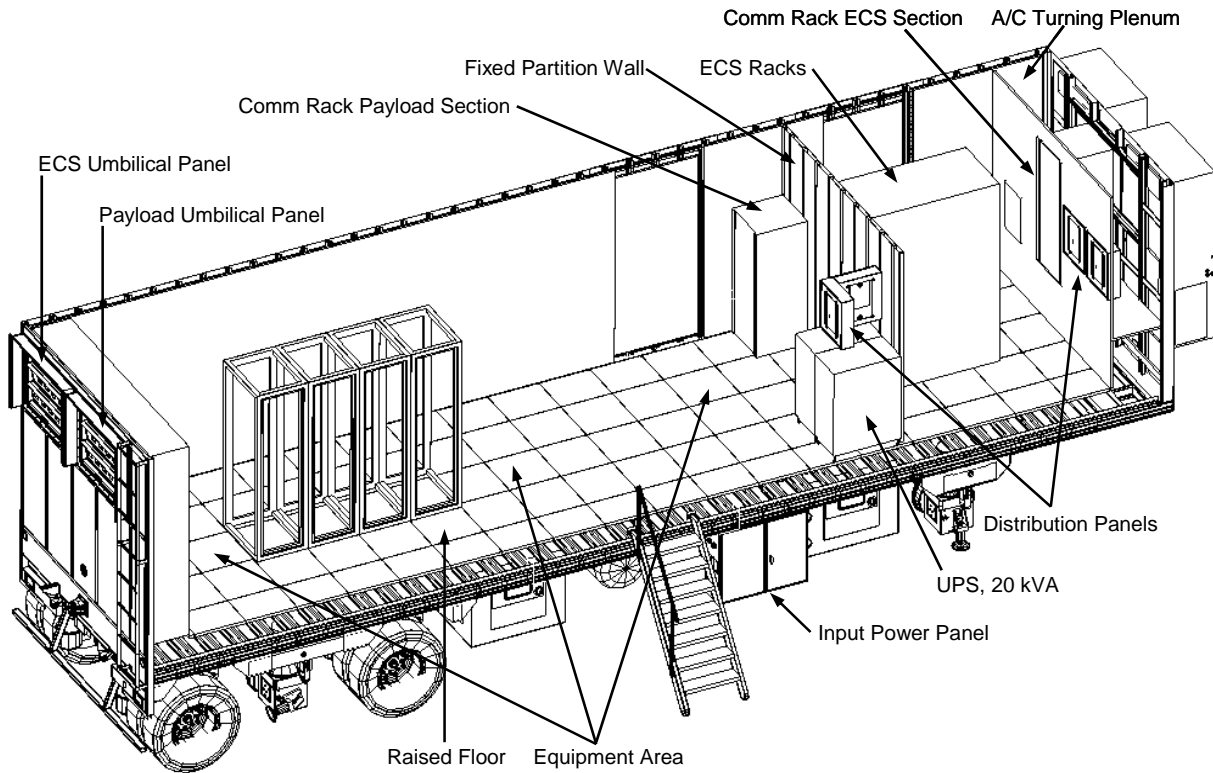
The PVan provides the electrical interface between the SC ground support equipment and the Atlas V T-0 umbilical that supplies the ground electrical services to the SC. The PVan provides 20-kVA Uninterruptable Power Supply (UPS) power for SC GSE racks. Power receptacles provided include eight 120-Vac, 15-A receptacles; two 120-Vac, 30-A receptacles; and four 120/208-Vac, three-phase, four-pole, five-wire receptacles. The PVan provides the supply and interface through the T-0 umbilical for Grade B or Grade C GN<sub>2</sub> at a flow rate up to 14.2 scmh (500 scfm) for SC instrument purge.

The Atlas V communication system provides SC communication connectivity from SC ground support equipment in the PVan to the Atlas V fiber-optic network. The communication network provides interfaces to the SC remote command and control station located at the Atlas Spaceflight Operations Center or PPF as illustrated in Figure 7.1.3.2-2. Additional remote SC processing sites may also access SC data by pre-coordinating with the Range for connectivity to the Atlas Spaceflight Operations Center. SC RF communications are routed from the PLF reradiating antenna to the PVan and then through the fiber-optic network. The communication system provides SC RF uplink and downlink capability at the VIF and at the pad. During flight, SC data can be interleaved with and deinterleaved from the LV telemetry stream.

The PVan is air-conditioned to maintain 20.6-25 °C (69-77 °F) and 35-70% relative humidity, assuming a SC support equipment heat load of 21,000 Btu per hour. The PVan provides interior lighting of 50 fc in the personnel work area. The PVan limits dynamic loads to 1.5 g during transportation. When the PVan is housed within the Pad Equipment Building (PEB), SC support equipment is protected from the launch induced environment, including overpressure, acoustics (<110 dB SPC at 1/3 OB center frequencies from 25 to 10,000 Hz), and thermal.

The PVan can be staffed during operations at the VIF, during transit to the pad, and on pad until final pad clear operations. PVan reconfiguration for each launch consists of transporting the PVan from the pad to the VIF, removing the previous user's equipment, performing baseline electrical checkout, and installing the SC support equipment for the current user.

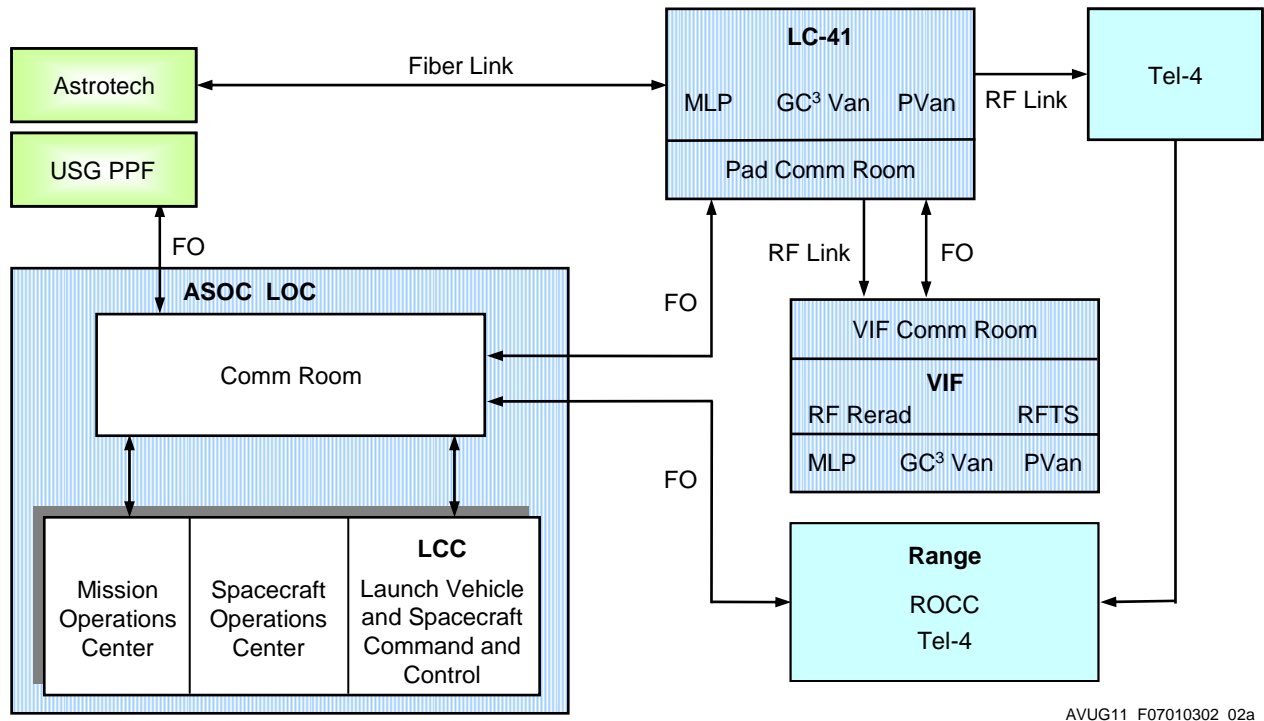
Figure 7.1.3.2-1: Payload Van



AVUG11\_F07010302\_01b



Figure 7.1.3.2-2: Communications Network



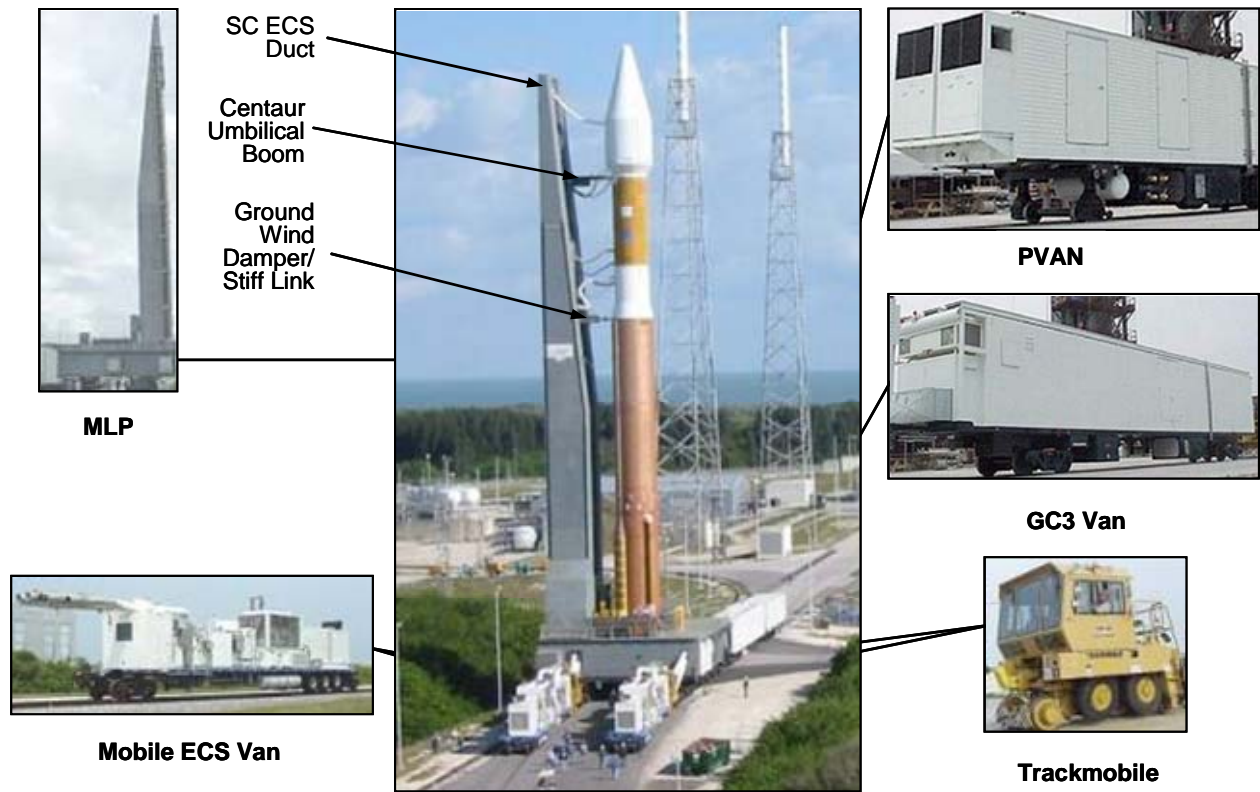
AVUG11\_F07010302\_02a

### 7.1.3.3 Mobile Launch Platform

The MLP, shown in Figure 7.1.3.3-1, consists of a structural steel frame capable of supporting the various Atlas V 400 and 500 series LV configurations. Supported operations include integration of the booster(s), mating of the Centaur and SC in the VIF, transport to the launch pad, LV fueling, final preparation for launch, thrust hold-down and release of the LV at launch. This frame is supported underneath by piers at the VIF and at the launch pad. The frame is rolled to these locations using four 227,000-kg (250-ton) rail cars equipped with a hydraulic jacking system for raising the MLP for movement and lowering onto the piers for stability. The MLP is moved between the VIF and launch pad by two track-mobiles that push the train. The MLP frame also supports the umbilical mast.

**Mobile Launch Platform Umbilical Mast** — The Atlas V MLP includes an umbilical mast for electrical, fluids, and gas servicing during final countdown, eliminating the need for an on-pad umbilical tower. All umbilical interfaces are connected and checked out in the VIF before rollout to the pad. The T-0 umbilicals remain connected up to launch. During transit from the VIF to the launch pad, LV and SC conditioned air is provided using an air conditioning trailer connected to the MLP. The MLP includes common ductwork allowing switching between facility-provided and trailer-provided conditioned air sources without interruption of conditioned air services.

Figure 7.1.3.3-1: Mobile Launch Platform



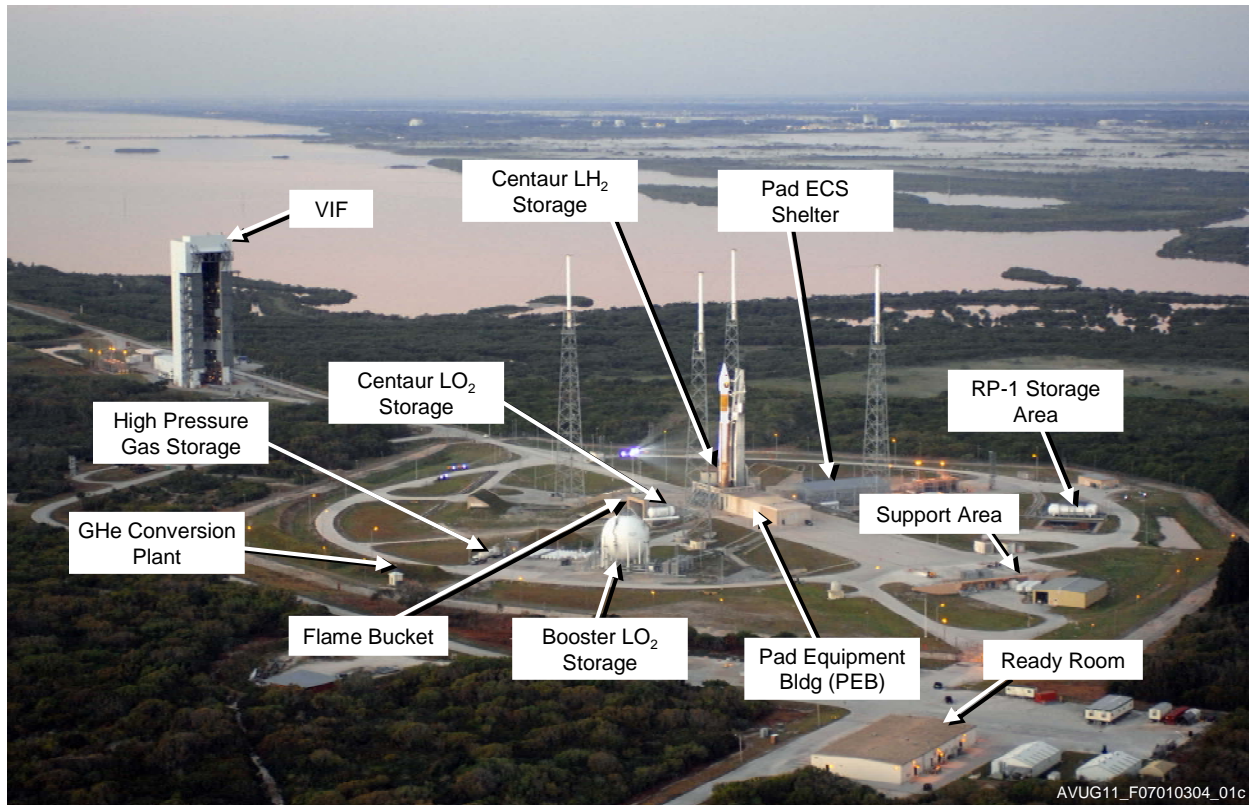
AVUG11\_F07010303\_01c

#### 7.1.3.4 Launch Pad

The Atlas V launch pad, shown in Figure 7.1.3.4-1, is located within the SLC-41 complex at CCAFS. The launch complex uses a “clean-pad” launch processing approach whereby the LV is fully integrated off-pad on the MLP in the VIF and the launch pad is used only for launch day LV propellant loads and launch countdown. There is an option to roll the day of launch if scheduled in advance; however, the standard procedure is to roll the day before launch. There are no provisions for SC access while the MLP is on the launch pad. (All final SC access activities, including removal of ordnance safe and arm devices, take place in the VIF.) All SC umbilicals needed at the launch pad are flyaway disconnects. Rollback from the launch pad to the VIF can be accomplished in 6 hours if LV propellants have not been loaded or within 24 hours if LV propellants must be detanked.

The launch pad operations continue to provide MLP and PVan interfaces. Payload compartment conditioned air is provided to the same parameters provided in the VIF. SC conditioned air is switched to GN<sub>2</sub> approximately 1 hour before Centaur cryogenic propellant operations. GN<sub>2</sub> cleanliness, temperature, and flow rate are the same as conditioned air, with maximum dew point of -37 °C (-35 °F).

Figure 7.1.3.4-1: Space Launch Complex 41



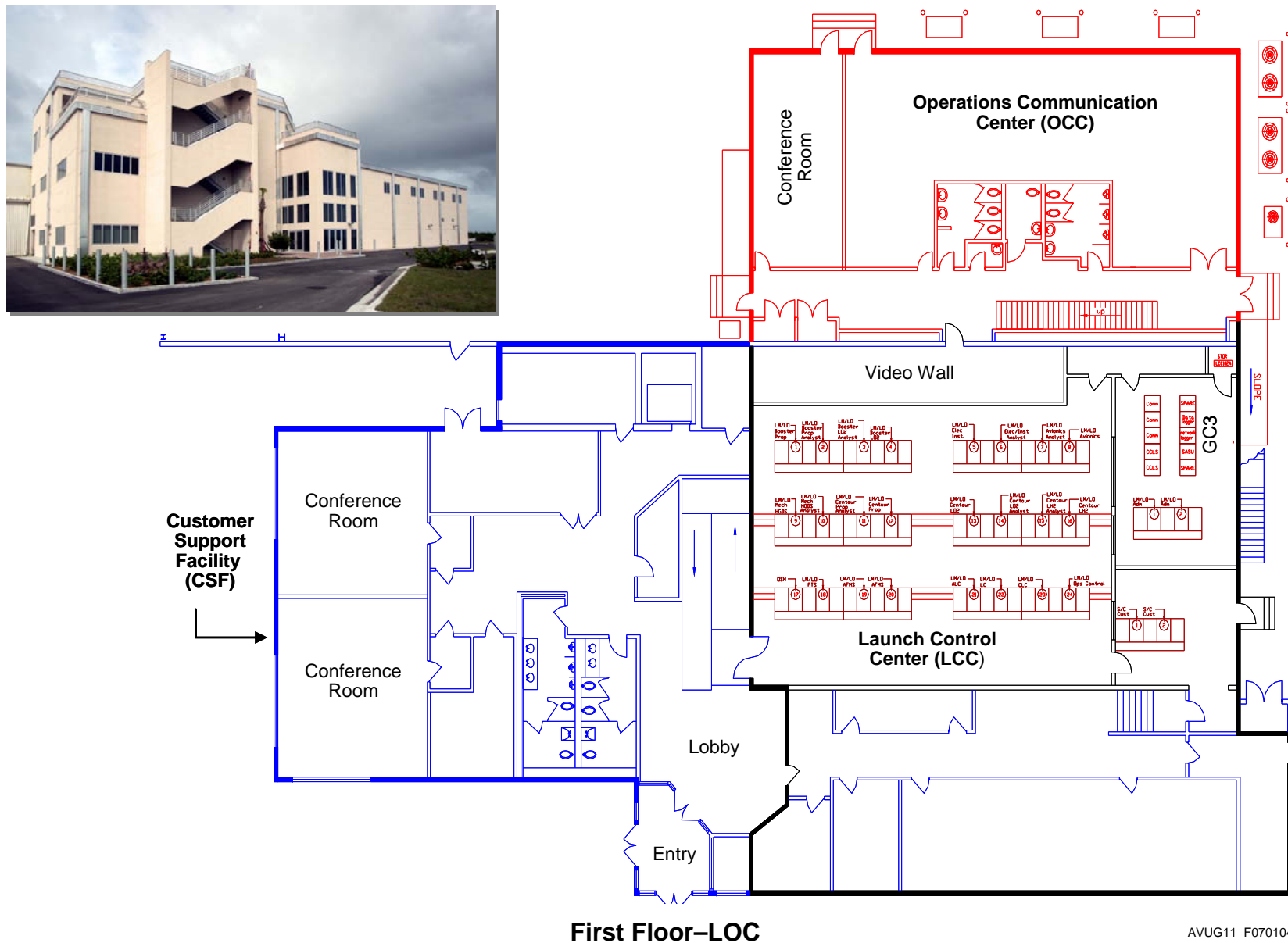
#### 7.1.4 Atlas Spaceflight Operations Center

The Atlas Spaceflight Operations Center (ASOC) is a multifunctional facility supporting LV hardware receipt and inspection, horizontal testing, and launch control. The ASOC is located approximately 4 miles from the SLC-41 complex. The Launch Operations Center (LOC) in the ASOC (Figures 7.1.4-1 and 7.1.4-2) provides SC interfaces for command, control, monitoring, readiness reviews, anomaly resolution, office areas, and day of launch viewing. The LOC design provides maximum flexibility to support varying customer requirements. The main areas of the LOC include the Launch Control Center (LCC); the Mission Director's Center (MDC); the Spacecraft Operations Center (SOC); the Engineering Support Area (ESA); the Customer Support Facility (CSF); the Operations Communication Center (OCC); Mission Support Rooms (MSRs); and the Ground Command, Control, and Communication (GC3) Support Area. Entry into the LCC is controlled by a personnel entry door equipped with electronic access system controls.

**Launch Control Center** — The LCC is the Atlas V LV command and control center for ULA engineering operating the real-time system, monitoring critical data, and for launch conductor coordination and control of the launch process.

**Mission Director Center** — The MDC provides SC customer positions combined with the ULA launch management team. Each position includes access to LV data, voice, and video. The stadium seating provides excellent viewing of the LCC video wall.

Figure 7.1.4-1: ASOC Launch Operations Center First Floor



AVUG11\_F070104\_01a





**Spacecraft Operations Center** — The SOC provides four SC monitoring positions. Each position includes access to LV and SC data, voice, and video. The stadium seating provides excellent viewing of the LCC video wall.

**Engineering Support Area** — The ESA provides twenty operator positions for ULA personnel. Each position includes access to LV data, voice, and video. The stadium seating provides excellent viewing of the LCC video wall.

**Customer Support Facility** — The CSF provides briefing and anomaly resolution areas; data, voice, video, hospitality areas; and day of launch viewing. The CSF includes easy access to other areas within the LOC.

**Operations Communication Center** — The Operations Communication Center (OCC) is the communications center for all Atlas V operations including networks, data circuits, voice, video, and telephone systems.

**Mission Support Rooms** — The Mission Support Rooms (MSR) provides space for customers and subcontractors use. Accommodations include data, communications, and video display with easy access to the conference rooms and the CSF.

**GC3 Support Area** — This area contains the ground processing computers and equipment, including system administration consoles and provisions for data recording and archiving.

#### 7.1.5 CCAFS Spacecraft Instrumentation Support Facilities

CCAFS area facilities described in this section can be used for SC checkout as limited by compatibility to SC systems. Special arrangements and funding may be required to use these assets.

**TEL4 Telemetry Station** — The ER operates an S-band telemetry receiving, recording, and real-time relay system on Merritt Island known as TEL4. This system is used for prelaunch checkout of LVs and SCs. A typical ground checkout configuration would include a reradiating antenna at the PPF, HPF, or launch pad directed toward the TEL4 antenna. Telemetry data can be recorded on electronic media or routed by hard-line data circuits to the spacecraft ground station for analysis. TEL4 also acts as the primary terminal for telemetry data transmitted from the ER downrange stations.

**Goddard Space Flight Center/Merritt Island Launch Area Station** — The Goddard Space Flight Center (GSFC)/Merritt Island Launch Area (MILA) station is located on Merritt Island. MILA is the ER launch area station for NASA's Ground Satellite Tracking and Data Network (GSTDN) Tracking and Data Relay Satellite System (TDRSS). This system includes satellite ground terminals providing access to worldwide communications. Circuits from MILA to the HPF, PPF, and SLC-41 complex are available to support checkout and network testing during prelaunch operations and spacecraft telemetry downlinking during day of launch and orbital operations. The MILA station can also support ground testing with TDRSS compatible spacecraft to include TDRSS links to White Sands, New Mexico. Special arrangements and documentation are required for TDRSS testing.

**Jet Propulsion Laboratory MIL-7.1 Station** — The Jet Propulsion Laboratory (JPL) MIL-7.1 station is co-located at MILA on Merritt Island and is an element of the JPL Deep Space Network (DSN). This station can be configured for ground tests similar to TEL4. In addition, data from SC that are compatible with the DSN can be relayed to JPL in Pasadena, California.

**Eastern Vehicle Checkout Facility/Transportable Vehicle Checkout Facility** — The Eastern Vehicle Checkout Facility (EVCF)/Transportable Vehicle Checkout Facility (TVCF) is an Air Force Space Control Network (AFSCN) ground station. It provides an S-band interface to AFSCN resources.

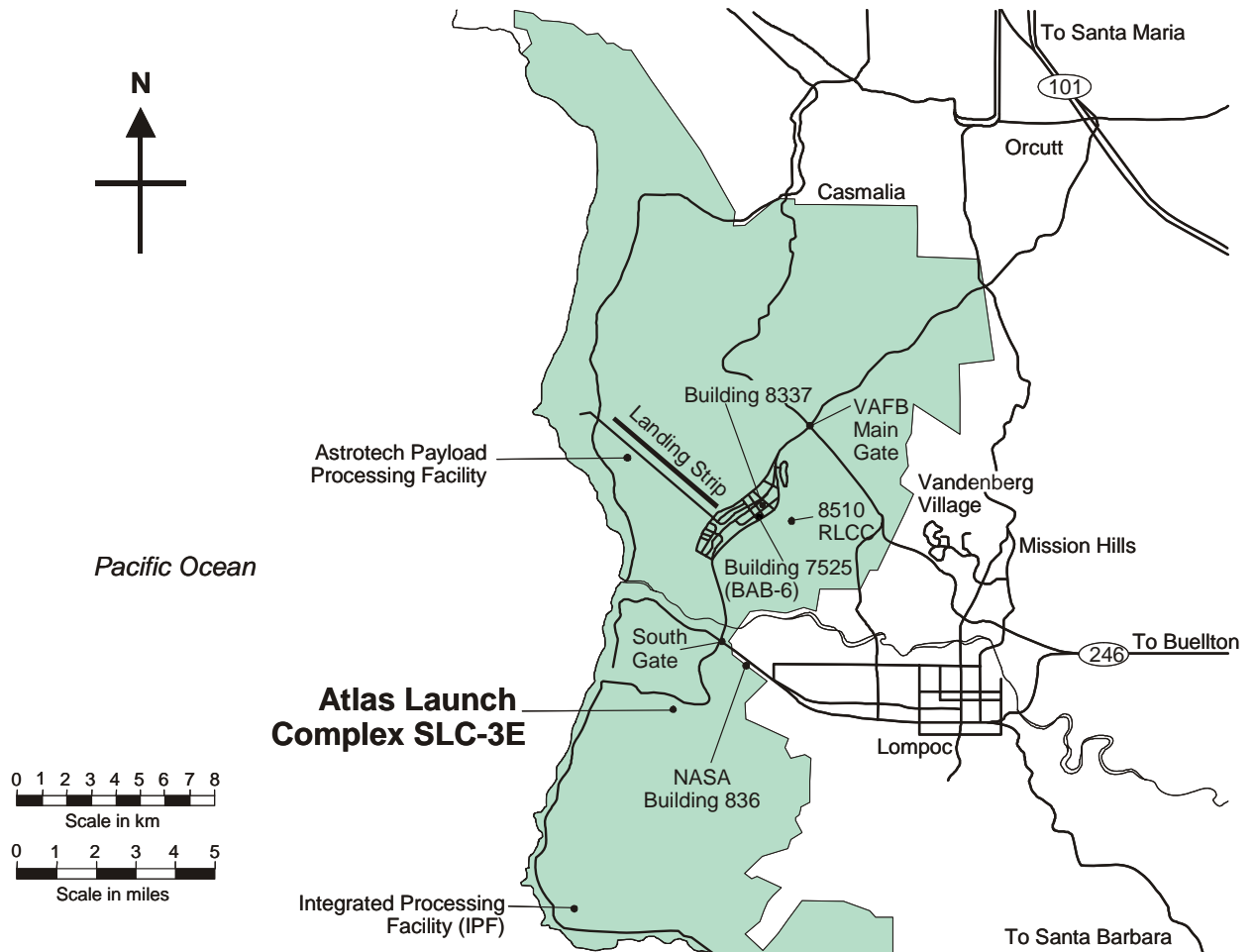
## 7.2 VANDENBERG AIR FORCE BASE ATLAS V LAUNCH FACILITIES

### 7.2.1 VAFB SPACECRAFT PROCESSING FACILITIES

SC facilities available to commercial and U.S. government facilities at VAFB include the VAFB Astrotech Payload Processing Facility and the Space Systems International (SSI) Integrated Processing Facility (IPF). Figure 7.2.1-1 illustrates the location of these facilities and the Atlas V Space Launch Complex SLC-3E.

Government facilities, as outlined in ULA/NASA and ULA/USAF agreements, are available for use should the commercial facilities not adequately satisfy SC processing requirements. The following sections describe these facilities. Please visit the Astrotech website at [www.spacehab.com](http://www.spacehab.com) for the current facility information.

Figure 7.2.1-1: VAFB Facility Locations



AVUG11\_F070201\_01a

### 7.2.1.1 Astrotech Facilities

The Astrotech/VAFB commercial Payload Processing Facility (PPF) owned and operated by Spacehab Inc., is available for processing Atlas V class civil, government, and commercial SC. The VAFB facility is capable of processing Atlas V 4-meter payload fairings. This facility supports final checkout and encapsulation of SC. Astrotech is currently building a 5-m high bay, please visit the Astrotech website at [www.spacehab.com](http://www.spacehab.com) for the latest PPF information.

This facility contains separate nonhazardous and hazardous processing buildings, storage buildings, and offices. The facilities and floor plans are described in the following sections. Astrotech complies fully with all applicable federal, state, regional, and local statutes, ordinances, rules, and regulations relating to safety and environmental requirements.

#### Astrotech PPF

The Astrotech/VAFB PPF can be used for all SC preparation operations, including liquid propellant transfer, Solid Rocket Booster (SRB) and ordnance installations, and SC encapsulation. The facility is near the VAFB airfield, approximately 12 km (7.5 miles) from SLC-3E. The PPF, shown in Figure 7.2.1.1-1, contains the following:

1. One airlock
2. Two high bays
3. Three low bays
4. Control rooms (one per high bay)
5. Auxiliary control room
6. Two walk-in coolers

In addition, a facility and customer support office approximately 21.3 m wide x 24.4 m long (70 ft x by 80 ft) is available (Figure 7.2.1.1-2), and is shared by Astrotech resident professional and administrative staff and customer personnel. Shared support areas include office space, a conference room, a copier, a facsimile, and amenities.

**Spacecraft Services** — A full complement of services can be provided at Astrotech to support SC processing and integration.

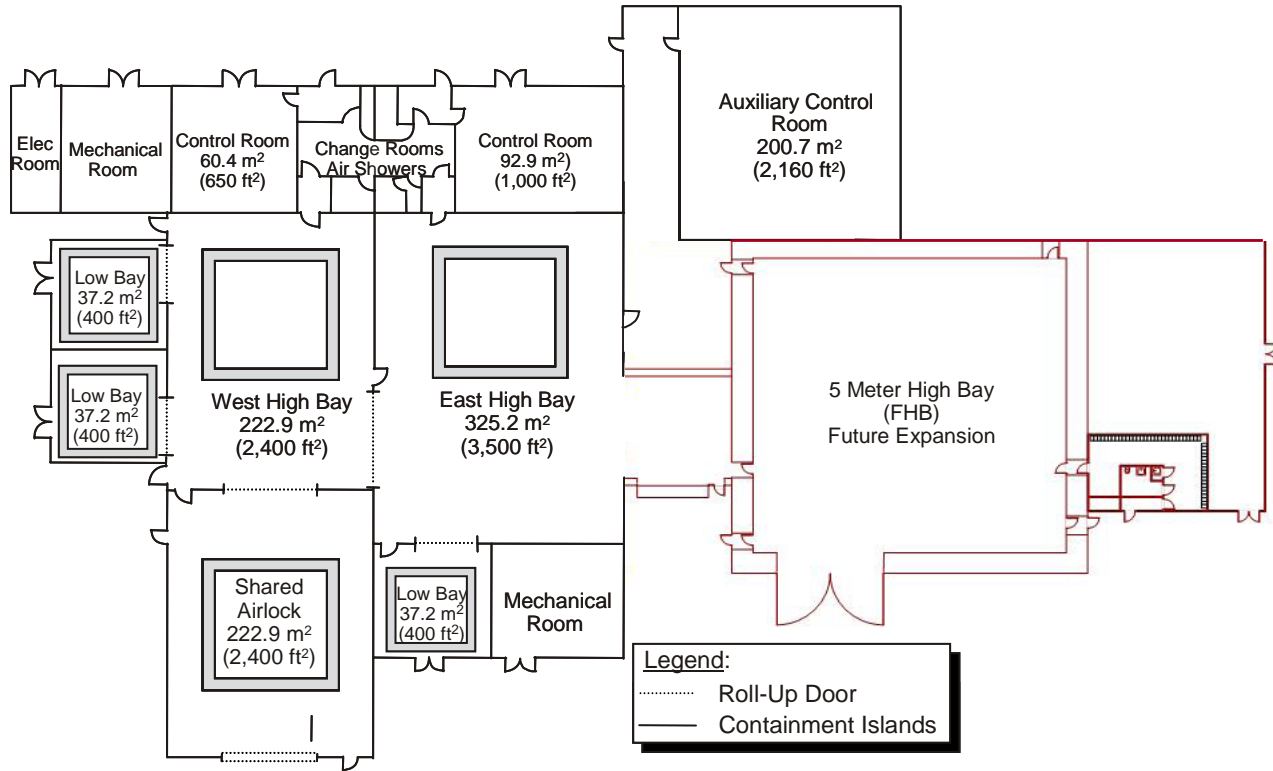
**Electrical Power** — The Astrotech/VAFB facility is served by 480-Vac/three-phase commercial 60-Hz electrical power that can be redistributed as 480-Vac/three-phase/30-A, 120/208-Vac/three-phase/60-A, or 125-Vac/single-phase, 20-A power to all major areas within the facility. A diesel generator backs up standard power during critical testing and launch periods.

**Telephone and Facsimile** — Astrotech provides all telephone equipment, local telephone service, and long distance access. A Group 3 facsimile machine is available and commercial telex service can be arranged.

**Intercommunication Systems** — The Operational Voice Intercommunication System provides internal intercom and a link to other facilities at VAFB. Transistorized Operational Phone System (TOPS) nets are available throughout the PPF. TOPS provide operational communications to other government facilities at VAFB. TOPS allows entrance into the government voice net for direct participation during flight readiness tests and launch countdowns. A paging system is also available throughout the complex.

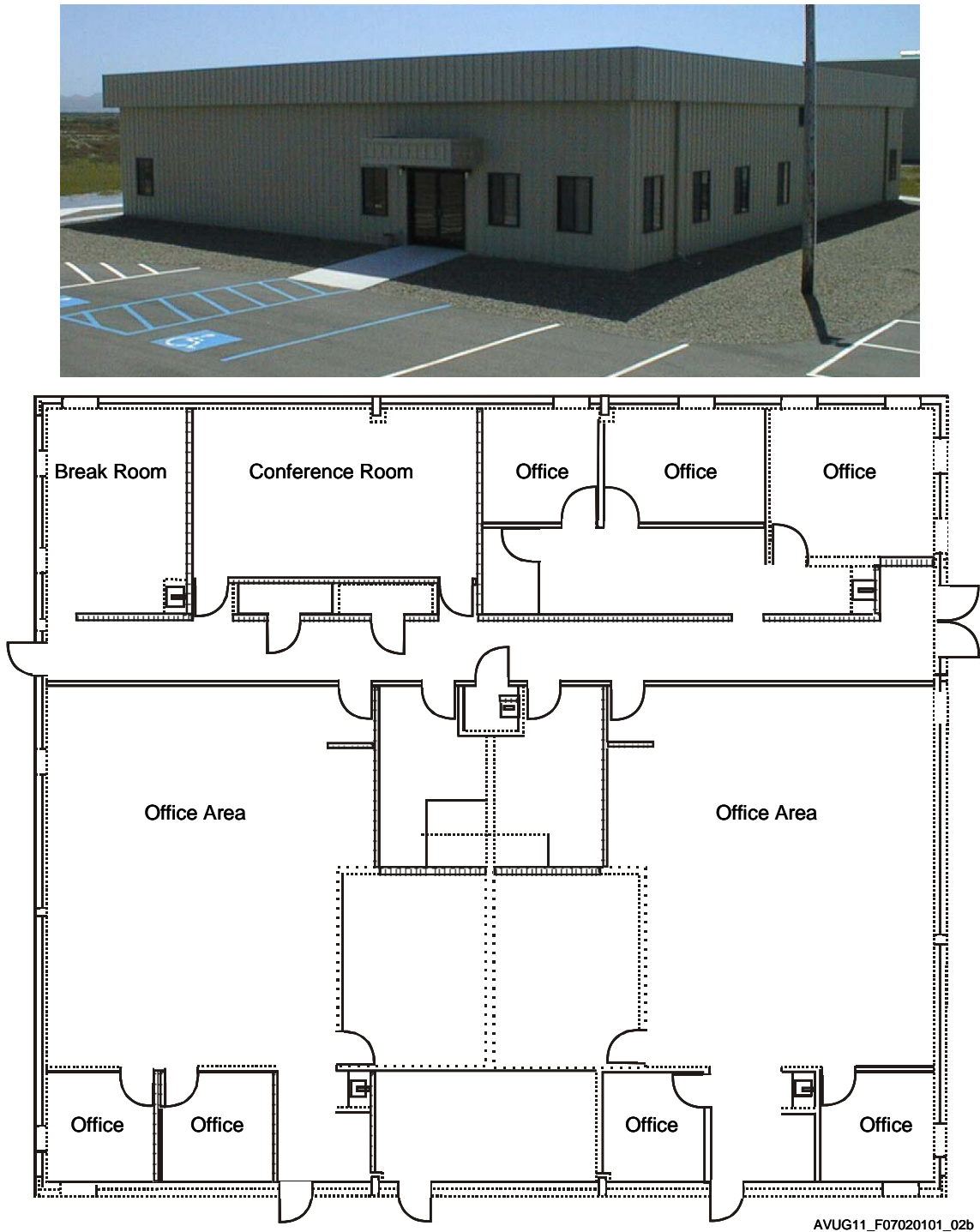


Figure 7.2.1.1-1: Astrotech/VAFB Payload Processing Facility Layout



AVUG11\_F07020101\_01b

Figure 7.2.1.1-2: Technical Support Building



AVUG11\_F07020101\_02b

**Closed-Circuit Television** — Five CCTV cameras are located in the PPF. Two are located in the processing high bays and one is in the airlock. CCTV can be distributed within the Astrotech/VAFB complex to any desired location, including the Auxiliary Control Room and Technical Support Building.

**Remote Spacecraft Control Center** — Astrotech has the capability to link remote ground stations (voice and data) between Astrotech and VAFB resources.

**Temperature/Humidity Control** — A 2,000-cubic feet per minute (cfm) Humidity, Ventilation, and Air-Conditioning (HVAC) control system provides reliable air conditioning for clean room operations and is capable of maintaining temperature at  $21 \pm 1.1$  °C ( $70 \pm 2$  °F) with a relative humidity of  $45 \pm 10\%$ . Positive pressure is maintained in all clean room areas. Air is circulated through the High-Efficiency Particulate Air (HEPA) filter bank at 3.5-4 room changes per hour. Differential pressure can be maintained between control rooms and clean rooms to prevent toxic vapor leaks into adjacent areas.

**Compressed Air** — A stationary, two-stage, rotary-tooth compressor supplies oil-free compressed air for breathing, shop air, and air pallet applications. The 30-horse power compressor provides 100 cfm at 125 pounds per in<sup>2</sup> (psi). Breathing air purifiers meet current Occupational Health and Safety Administration (OSHA), National Institute for Occupational Safety and Health (NIOSH), and U. S. Environmental Protection Agency (EPA) guidelines for production of Grade D breathing air.

**Security and Emergency Support** — Physical security is provided by a locked gate and two S&G locked entry doors. All doors providing access to closed areas are alarmed with remote readout at the VAFB Law Enforcement Desk. The alarm system design allows for completely segregated operations in the two processing high bays.

**Electromagnetic Interference Control** — While the Astrotech building structures may provide some electromagnetic shadowing capability, doors and windows preclude it from being considered an effective EMI shield. EMI shielding attenuation values have not been quantified.

#### 7.2.1.2 Spaceport Systems International Facilities

The IPF owned and operated by Spaceport Systems International (SSI) is available for processing Atlas V class civil and government SC. The IPF is capable of processing both 4-m and 5-m payload fairings. This facility supports final checkout and encapsulation of SC. Depending on VAFB launch interest and U.S. government SC processing requirements for Atlas/Centaur class SC, the IPF facility offers compatibility with SC contractor and ULA use requirements.

The IPF (Figure 7.2.1.2-1) contains hazardous processing cells, storage capabilities, and technical support areas. The facility floor plan is described in the following sections. The IPF complies fully with all applicable federal, state, regional, and local statutes, ordinances, rules, and regulations relating to safety and environmental requirements.

The IPF may be used for all SC preparation operations, including liquid propellant transfer, SRB and ordnance installations, and SC encapsulation. The facility is located on south VAFB approximately 11 km (6.8 miles) from SLC-3E. The PPF contains the following as shown in Figures 7.2.1.2-2 and 7.2.1.2-3:

1. One Air Lock
2. One High Bay

Figure 7.2.1.2-1: Integrated Processing Facility



AVUG11\_F07020102\_01a

3. Three Checkout and Processing Cells
4. Control Room
5. Common and Technical Support Areas

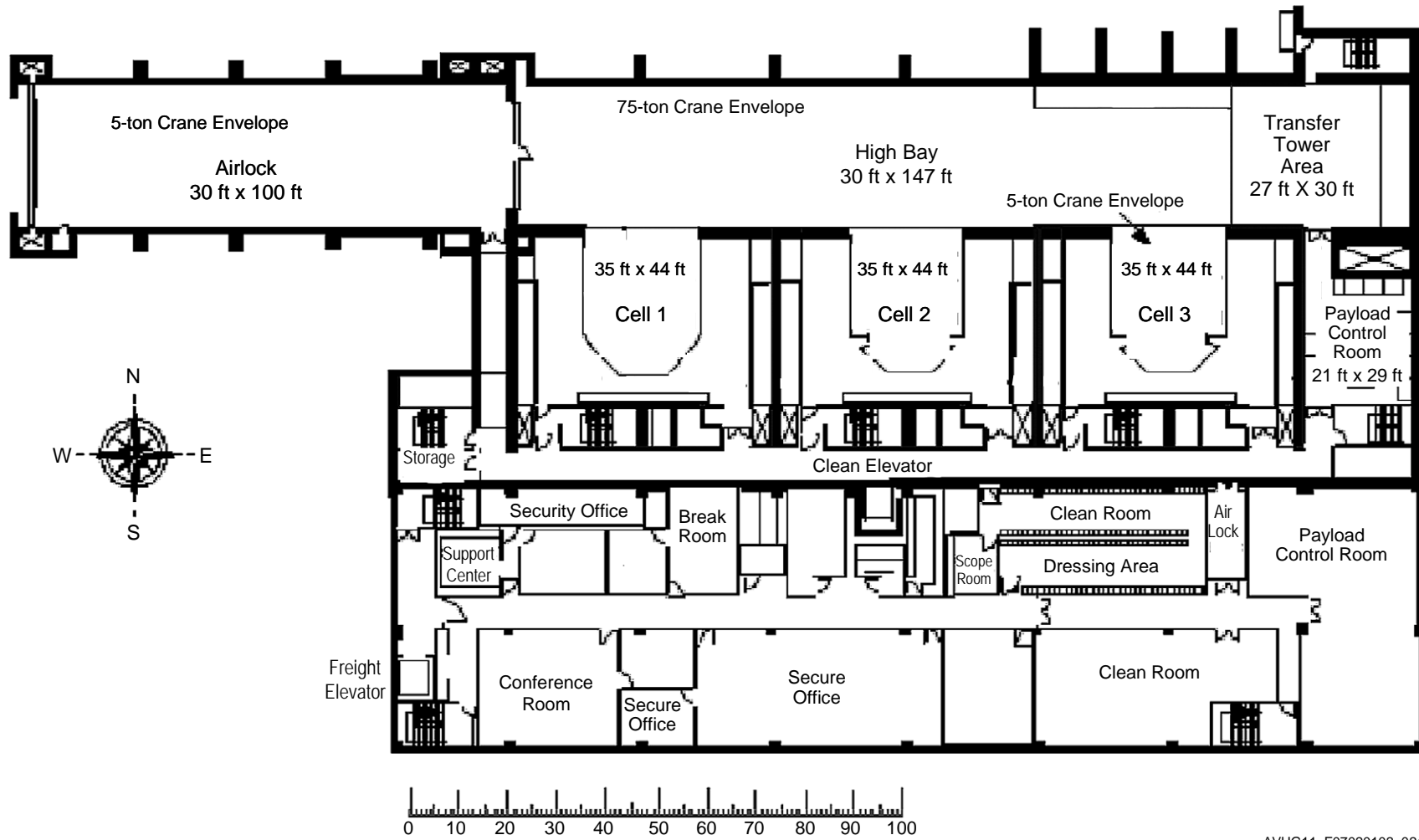
**Airlock** — As a buffer area for operations between the external environment and the main processing areas, the IPF airlock has significant processing capability of its own, including:

1. A 7.3 m wide x 8.5 m high (24 ft x 28 ft, 1in) door between the Airlock and the High Bay
2. 11.8 m x 39.4 m (30 ft x 100 ft) working area
3. Two 4.5-tonne (5-ton) overhead cranes with a maximum hook height of 14 m (35 ft, 5 in)
4. 125 VAC utility power
5. Facility ground
6. Explosion proof fixtures
7. Shop air
8. Class 100,000 clean (10,000 functional)
9. Central vacuum system
10. CCTV capability
11. OVS capability
12. Telephones
13. Single and multi-mode fiber optic interface (future)

**High Bay** — In addition to providing an access area to the Payload Checkout Cells, High Bay capacity allows use for full processing of SC and/or booster components. Highbay features include:

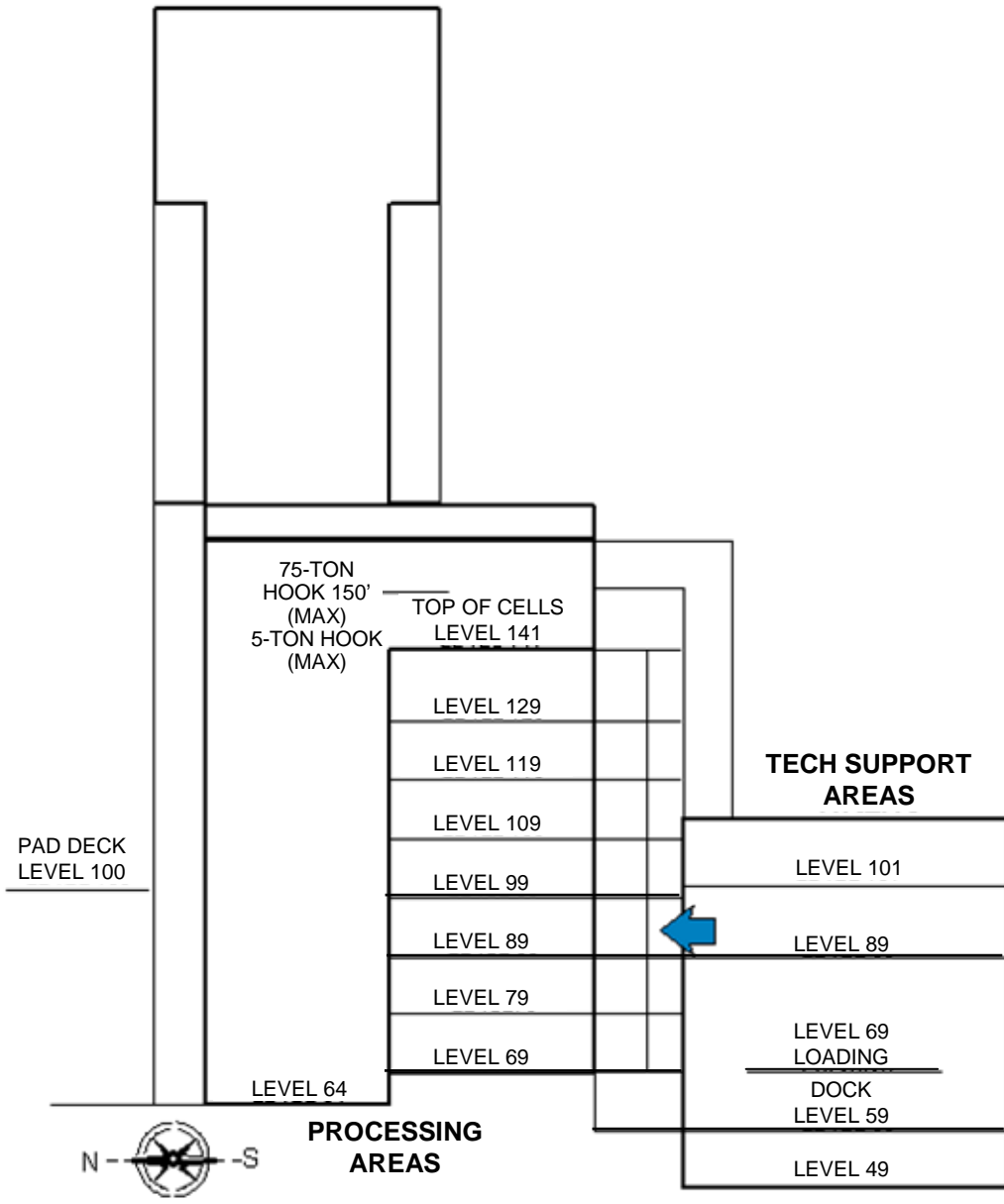
1. Class 100,000 clean (10,000 functional)
2. Access to the High Bay is through the 9.5 m (24 ft) wide x 11 m (28 ft) door from the Airlock
3. Work area is 11.8 m x 57.9 m (30 ft x 124 ft, 7 in)
4. 68-tonne (75-ton) bridge crane. The hook height in the High Bay is 34 m (86 ft, 4 in)
5. Shop Air
6. Central Vacuum System
7. Explosion proof fixtures
8. 125 VAC utility power, 120/208 VAC tech power
9. Facility Ground
10. CCTV capability
11. Telephones
12. The airlock and the High Bay are on Level 64

Figure 7.2.1.2-2: IPF Floor Plan



AVUG11\_F07020102\_02a

Figure 7.2.1.2-3: IPF Side View



AVUG11\_F07020102\_03c

**Payload Processing Cells** — Three 13.8 m x 17.3 m (35 ft x 44 ft) Payload Checkout Cells are serviced by a 68-tonne (75-ton) bridge crane with 32-m (81 ft, 4 in) hook height. Each cell also has 4.5-tonne (5-ton) crane support with hook height of 28.3 m (71 ft, 11 in). Access to each cell is through doors from the High Bay with a total horizontal opening of 8.4 m (21 ft, 2 in). Payload processing cell features include:

1. GN<sub>2</sub> and Gaseous Helium (GHe) are supplied by K-bottles or tube banks
2. 60-tonne (75-ton) crane with micro drive services all cells and the High Bay
3. 4.5-tonne (5-ton) crane with micro drive in each cell
4. Class 100,000 clean (10,000 functional)

5. In addition to the cell floor at Level 69, there are six platform levels in each of the three processing cells — 24.1 m (79 ft), 27.1 m (89 ft), 30.2 m (99 ft), 33.2 m (109 ft), 36.3 m (119 ft), and 39.3 m (129 ft)
6. Finger platforms for adjustable diameter segments (not in Cell 1)
7. 125, 120/208, and 480 VAC power
8. Facility and technical grounds
9. Cell separators for two levels
10. Elevator/corridor access for GSE; 1.2m x 1.8m x 2.1m (4ft x 6ft x 7ft) envelope at 1,493 kg (4,000 lbs.) max
11. Shop Air
12. Central Vacuum System
13. Explosion-proof fixtures
14. CCTV capability (Cells 2 & 3)
15. OVS capability
16. Telephones
17. Single & multi-mode fiber optic interface (Cells 2 & 3)
18. Fuel vent

**Control Room** — When configured as a Payload Control Room, SSI Spaceport control functions are located in one of several other IPF locations, and the Facility Monitoring and Control Workstation is relocated accordingly. There are several similar rooms located above Room 7903.

**Technical Support Rooms** — The facility provides the following common and technical support rooms:

**Break Room** — Room 8925 is available for use by all personnel in the IPF. It contains a microwave oven, refrigerator, and a selection of snacks for sale.

**Conference Room** — The Conference Room is available to all IPF personnel on an "as available" basis.

**Technical Support Room** — Room 8914 at 104.4 m<sup>2</sup> (1124 ft<sup>2</sup>) is one of several technical support office areas, which can be outfitted to customer requirements. Room 10102 at 107.4 m<sup>2</sup> (1156 ft<sup>2</sup>), room 10104 at 150.6m<sup>2</sup> (1621 ft<sup>2</sup>) and room 10106 at 148.6 m<sup>2</sup> (1600 ft<sup>2</sup>) are similar.

### 7.2.2 Spacecraft Encapsulation and Transportation to SLC-3E

During the SC processing campaign, ULA requires use of the PPF/IPF for approximately 30 days to receive and verify cleanliness of the PLF and to encapsulate the SC.

After SC encapsulation, ULA transports the encapsulated SC to SLC-3E and mates the encapsulated SC assembly to the LV. Transportation hardware and procedures will be similar to those used at the East Coast SLC-41 launch complex (Section 7.1.2). Post-mate SC testing may take place from GSE located on the



mobile service tower, in the launch support building payload user's room, or through connectivity to the VAFB Fiber-Optics Transmission System (FOTS) from offsite locations.

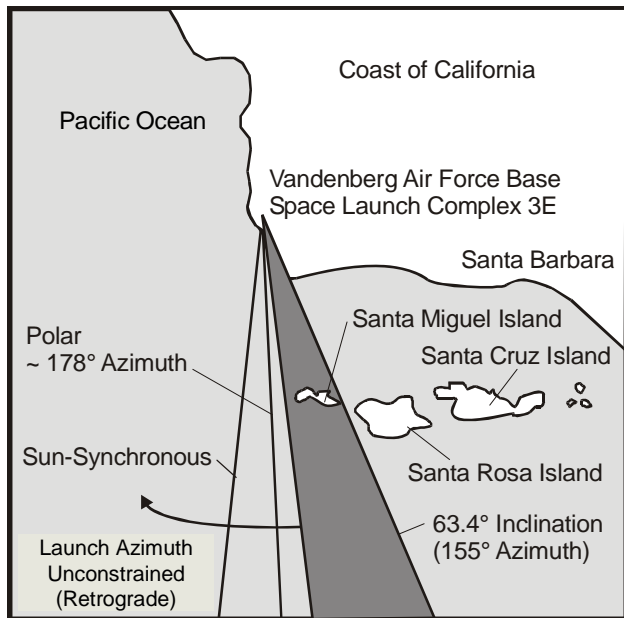
### 7.2.3 Atlas V Space Launch Complex-3E

SLC-3E at VAFB in California has supported the launch of Atlas vehicles since the 1970s. In 1992, the USAF contracted with ULA to convert the inactive SLC-3E site to support the launch of Atlas/Centaur to orbits not attainable from the East Coast CCAFS launch site (Figure 7.2.3-1). The Initial Operational Capability (IOC) of SLC-3E for Atlas IIAS was late 1997. The launch complex was modified to accommodate Atlas V LVs. The first Atlas V launch from SLC-3E occurred on March 13, 2008 (Figure 7.2.3-2). This section discusses facilities that are or will be available to support SC and Atlas V LV integration and launch.

SLC-3E is located on South VAFB, 11 km (7 miles) from the base industrial area on North VAFB and approximately 6.5 km (4 miles) from NASA Building 836. Figure 7.2.1-1 shows SLC-3E, Building 8510 and Building 7525 for reference. Major facilities at SLC-3E include the Mobile Service Tower (MST), Umbilical Tower (UT), Launch Support Building (LSB), and a Launch Operations Building (LOB).

The Remote Launch Control Center (RLCC) is located in Building 8510 on North VAFB. Building 7525, also located on North VAFB, is used for LV receiving and inspection. High-volume, high-pressure  $\text{GN}_2$  is supplied to the SLC-3E site from the South Vandenberg nitrogen generation plant operated by the USAF.

Figure 7.2.3-1: SLC-3E Available Launch Azimuths



AVUG11\_F070203\_01b

#### 7.2.3.1 Mobile Service Tower

The Mobile Service Tower (MST) is a multilevel, movable, totally enclosed steel-braced frame structure for servicing of LVs and SC (Figure 7.2.3.1-1). A truck system on rails is used for transporting the MST from its park position at a point approximately 76.2 m (250 ft) south of the LSB to its service position over the launcher. The tower is secured in place with a seismic tie-down system at both tower positions. The MST is normally in place over the launch pad except during major systems tests and before cryogenic tanking during the launch countdown sequence.

The MST has 19 levels. A hammerhead overhang is incorporated at the top of the structure on the north side to allow a 54.4-tonne (60-ton) overhead bridge crane on Level 21 to move outside the MST for erection and mating of the Atlas V, Centaur, and SC. The various MST levels provide access to the Atlas V booster, the Centaur, and the SC. It also provides a lighted, weather-protected work area for erection, mating, and checkout of the flight vehicle.

In addition to external siding, the MST incorporates a Payload Controlled Area (PCA) around the vehicle on Levels 14 through 17 to protect the SC and SC dedicated GSE located in the MST.



Figure 7.2.3-2: Space Launch Complex 3-East



### 7.2.3.2 Umbilical Tower

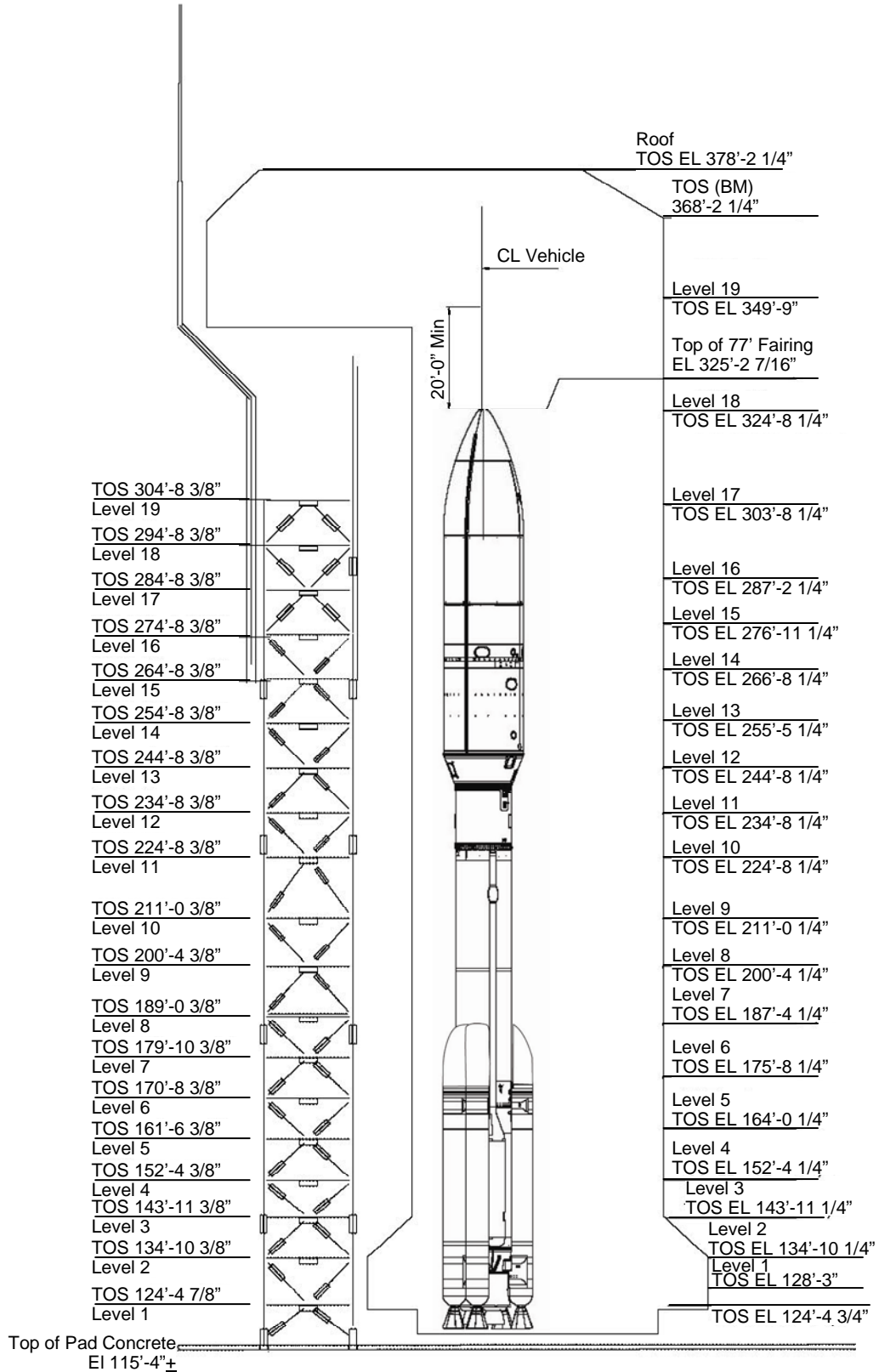
The Umbilical Tower (UT) is a steel structure with 16 levels. The UT supports a draped umbilical and a ground wind damper. The draped umbilical supplies conditioned air to the SC via its connection to the PLF. The umbilical tower supports power cables, command and control cables, propellant and gas lines, monitoring cables, and air-conditioning ducts routed from the LSB pad deck to appropriate distribution points.

### 7.2.3.3 Launch Support Building

The Launch Support Building (LSB) is a reinforced concrete and steel structure that is the platform on which the Atlas V family of vehicles is assembled, tested, and launched. The top of the LSB, or LSB pad deck, provides support for the Atlas V launcher and the MST while in the service position. The LSB pad deck is also a support structure for the UT that has supporting columns extending down through the upper-level pad deck and lower-level foundation into the ground. The LSB provides a protective shelter for shop areas, storage, locker rooms, air-conditioning equipment, electrical switch gear, instrumentation, fluid and gas transfer equipment, launch control equipment, and other launch-related service equipment.

LSB equipment is a front end for all Aerospace Ground Equipment (AGE) and vehicle control functions. This equipment issues commands as requested by operators, provides safing when operator connections are broken, and acquires data for monitoring of all pad activities. The LSB also contains a payload user's room (Room 219) for locating SC dedicated GSE.

Figure 7.2.3.1-2: SLC-3E Atlas V to MST Relationship



#### 7.2.3.4 Launch Operations Building

The Launch Operations Building (LOB) is a reinforced concrete and steel structure that provides 24-hour launch complex safety monitoring and control. The LOB provides 24-hour monitoring for critical systems and command and control capabilities except during hazardous operations, when responsibility is transferred to the Remote Launch Control Center. Systems that are monitored from the LOB include the environmental control system, the fire and vapor detection system, and the fire suppression and deluge system.

#### 7.2.3.5 SLC-3E Spacecraft Support Services

Electrical interfaces exist in the LSB payload user's room and the MST on Levels 14 and 17. This power is available in 120-V 20-A, 208-V 30-A, and 208-V 100-A technical power. Critical technical power circuits, 120-V 20-A and 208-V 30-A, are also provided and are backed up by uninterruptible power systems.

To support SC testing while in the MST, GN<sub>2</sub> and GHe support services are supplied as part of the facility on MST Levels 14, 15, and 16. Type 1, Grade B, GN<sub>2</sub> per MIL-P-27401 is supplied through a 2-micron nominal, 10-micron absolute filter in the pressure ranges of 0-100, 0-400, 1,500-3,600, and 2,500-5,000 psig. Type 1, Grade A, GHe per MIL-P-27407 is also supplied through a 2-micron nominal, 10-micron absolute filter in the pressure ranges of 0-100 and 2,500-5,000 psig. Both clean gas and contaminated gas vent systems exist on MST Levels 14, and 15. Contingency offload of SC propellants is supported via the facility SC propellant deservicing system. Propellant deservicing interfaces exist on MST Levels 14, and 15 with ground interfaces at the propellant-deservicing pad, with portable fuel and oxidizer scrubbers connected to the MST contaminated vent system. A SLC-3E breathing air system is available on MST Levels 14, and 15, at the propellant deservicing pad, and at the scrubber pad to support Self-Contained Atmospheric-Protective Ensemble (SCAPE) operations required for SC processing.

The LSB contains a payload user's room (Room 219) to support SC testing (Figure 7.2.3.5-1). The user's room is electrically interconnected to the T-0 umbilical. Support cables are terminated at a connector interface panel for connection to the user's GSE located in Room 219. Capability also exists to connect the user's room to the Fiber Optics Transmission Set/System (FOTS) for connectivity to offsite locations. Room 219 must be evacuated at approximately 3 hours prior to launch. SC support equipment is protected from the launch-induced environment acoustics (<130.2 dB OASPL).

#### 7.2.4 Remote Launch Control Center

Figure 7.2.4-1 shows the Remote Launch Control Center (RLCC) located in Building 8510, which is the focal point for launch site test monitoring and recording. The RLCC supports routine daily vehicle and AGE processing activities and total monitor and control over hazardous operations requiring launch site evacuation (i.e., wet dress rehearsal and launch). AGE systems in the RLCC (with interconnectivity between the RLCC and the LSB and LOB at SLC-3E) provide command control and monitoring of the overall launch control system. The RLCC also provides RLCC-to-SLC-3E communications, launch site control interfaces between the Computer Controlled Launch Set (CCLS), LV and AGE, and, through the Safe/Arm and Securing Unit, control of safety-critical functions independent of the CCLS and RLCC-to-SLC-3E AGE interface links.

Similar to the LOC at the ASOC on the East Coast, the RLCC houses Atlas LCC, MDC, MDC annex (similar to SOC), ESA, MSRs, and GC3 functions in support of Atlas V processing and test operations.

Figure 7.2.3.5-1: Launch Services Building Spacecraft User's Room 219

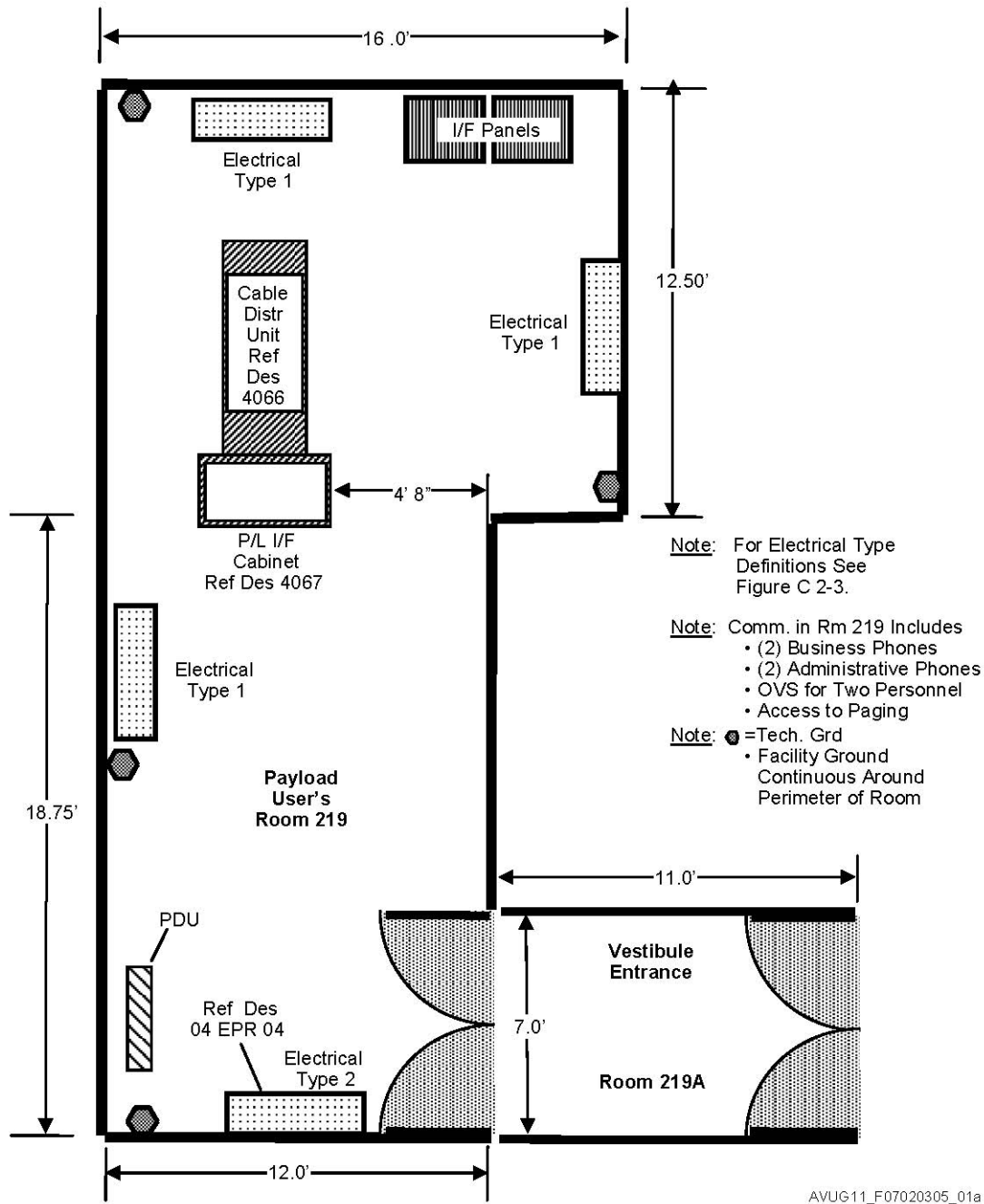
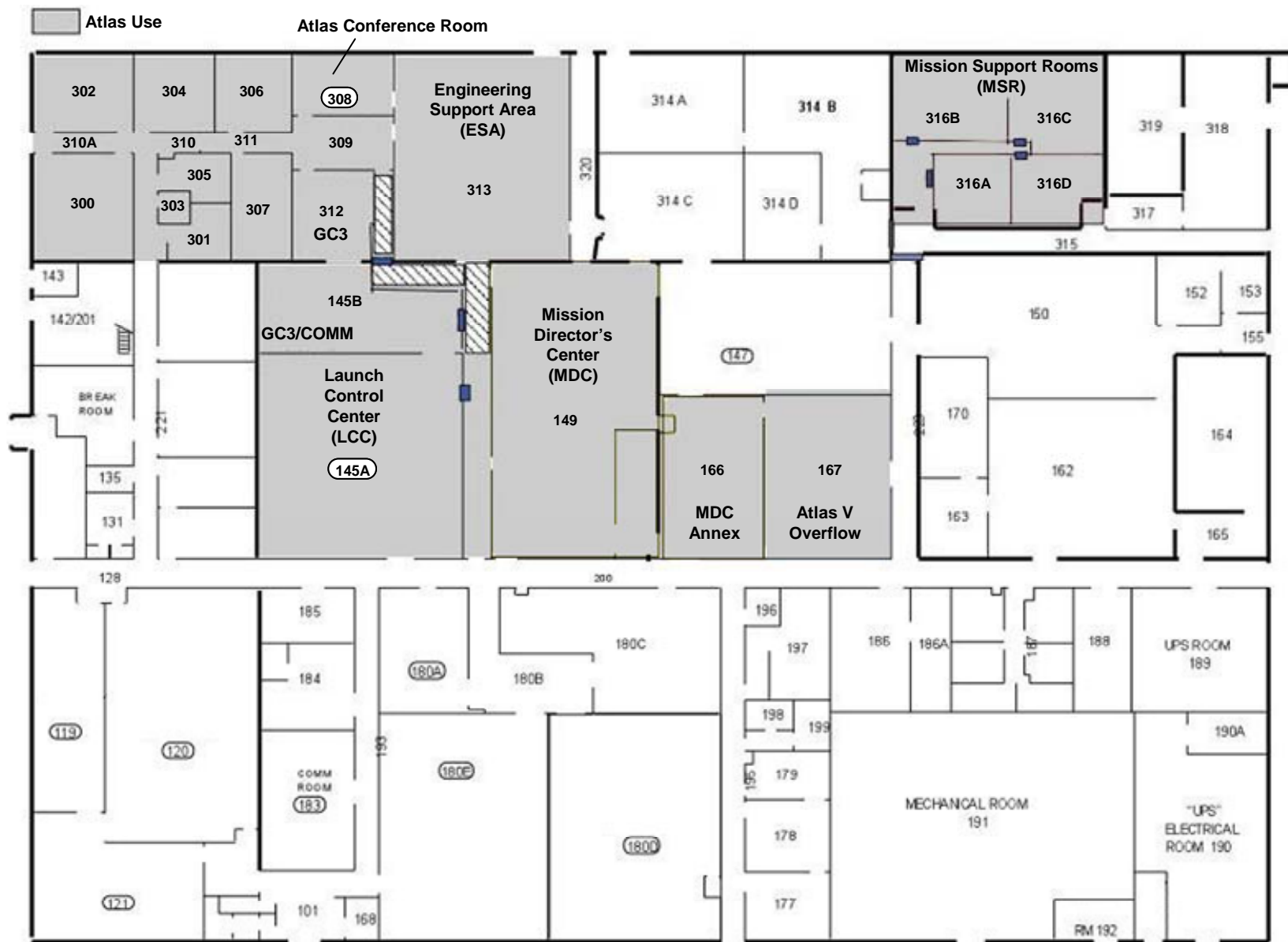


Figure 7.2.4-1: Atlas RLCC Area within Building 8510



AVUG11\_F070204\_01a

**7.3 ADDITIONAL EAST COAST AND WEST COAST FACILITIES**

ULA has formal agreements with the USAF, NASA, and Spacehab Inc. for use of SC and LV processing facilities at and near Atlas V launch sites at CCAFS, Florida. Similar agreements for sites at VAFB in California have been implemented.

**7.3.1 Additional CCAFS Processing Facilities**

**7.3.1.1 NASA Facilities**

**7.3.1.1.1 Payload Hazardous Servicing Facility**

The Payload Hazardous Servicing Facility (PHSF) is a NASA facility located southeast of the KSC industrial area. Features of the PHSF Service Building are described in Table 7.3.1.1.2-1.

**Table 7.3.1.1.2-1: NASA PHSF Building — Hazardous Processing Facility**

<b>Service Bay</b>		
Floor Space	18.4 x 32.6 m	60 x 107 ft
Ceiling Height	28.9 m	94 ft 10 in.
Door Dimensions	10.8 x 22.9 m	35 x 75 ft
Crane Capacity	45.40 tonne	50 ton
Hook Height	25.5 m	83 ft 6 in.
<b>Airlock</b>		
Floor Space	15.3 x 25.9 m	50 x 80 ft
Ceiling Height	27.4 m	89 ft 10 in.
Door Dimensions	10.8 x 22.9 m	35 x 75 ft
Crane Capacity	13.60 tonne	15 ton
Hook Height	22.9 m	75 ft
<b>Equipment Airlock</b>		
Usable Space	4.1 x 8.0 m	14 x 26 ft
Ceiling Height	3.2 m	10 ft 4 in.
Door Dimensions	3.0 x 3.0 m	10 x 10 ft
<b>Environmental Controls</b>		
Filtration	Class 100,000	
Air Change Rate	Four per Hour	Minimum
Temperature	21.7 ±3.3 °C	71 ±6 °F
Relative Humidity	55% Maximum	

**7.3.1.2 USAF Facilities**

**7.3.1.2.1 Defense Satellite Communications System Processing Facility**

The Defense Satellite Communications System (DSCS) Processing Facility (DPF) is a USAF facility accommodating hazardous and nonhazardous SC processing operations (Figure 7.3.1.2.1-1). It provides an area in which to process and encapsulate SC off pad (limited to LPF/Round Tube Torus configurations). Figure 7.3.1.2.1-2 is an overview of the DPF site. The facility was designed to accommodate a DSCS III class SC consisting of a DSCS III SC and integrated apogee boost subsystem.

The facility can accommodate 9,000 kg (20,000 lb) of bipropellant and/or 9,000 kg (20,000 lb) of SRBs. The DPF is partitioned into two primary operating segments. The HPF segment consists of two high bay test cells; the nonhazardous PPF segment consists of one low bay test cell plus all other test and facility operations support areas.

Each HPF bay is a Class 100,000 clean room with approximate dimensions of 15.2 x 15.2 x 16.8-m high (50 x 50 x 55-ft high). The two cells in the HPF have been assigned the following functions:

1. East Bay — Prelaunch processing of the PLF and encapsulation of the SC within the PLF. It can also be used as a fueling cell to assemble SRBs.
2. West Bay — Bipropellant loading cell that can also be used to assemble SRBs. There is no overhead crane in this room.
3. Main Bay — Intended for nonhazardous electrical and mechanical operations and integration of SC elements before fueling. Leak testing and ordnance installation may be accomplished with approval from Range Safety. The main bay is a Class 100,000 clean room. Room environment is typically maintainable at 21.1±2.8 °C (70 ±5 °F) with a relative humidity of 30 to 50%.

The bay is 30.5 m (100 ft) long north-south, approximately 15.2-m (50 ft) wide east-west, and 7.6 m (25 ft) high. It is equipped with a 4,500-tonne (5-ton) crane with a hook height of 6.1 m (20 ft).

Please contact ULA for additional DPF information.

### 7.3.2 VAFB Facilities

#### 7.3.2.1 Other Spacecraft Processing Facilities

Building 2520 PPF, which is owned and operated by the National Reconnaissance Office (NRO), supports all SC preparation operations, including liquid propellant transfer, SRB and ordnance installations, and 4-m PLF encapsulation operations. Availability is subject to conditions as outlined in ULA/NRO agreements.

Figure 7.3.1.2.1-1: CCAFS Spacecraft Processing Facilities

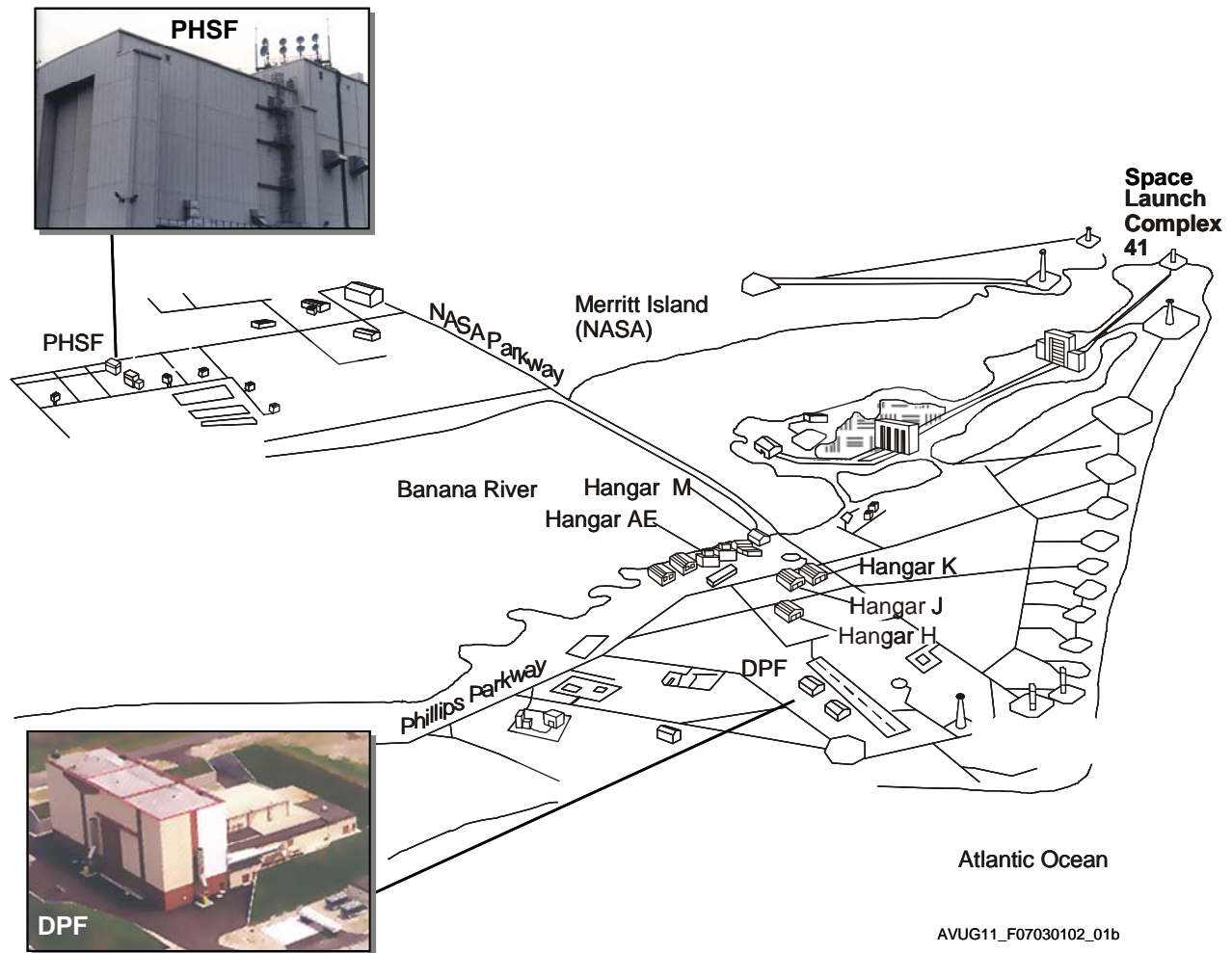
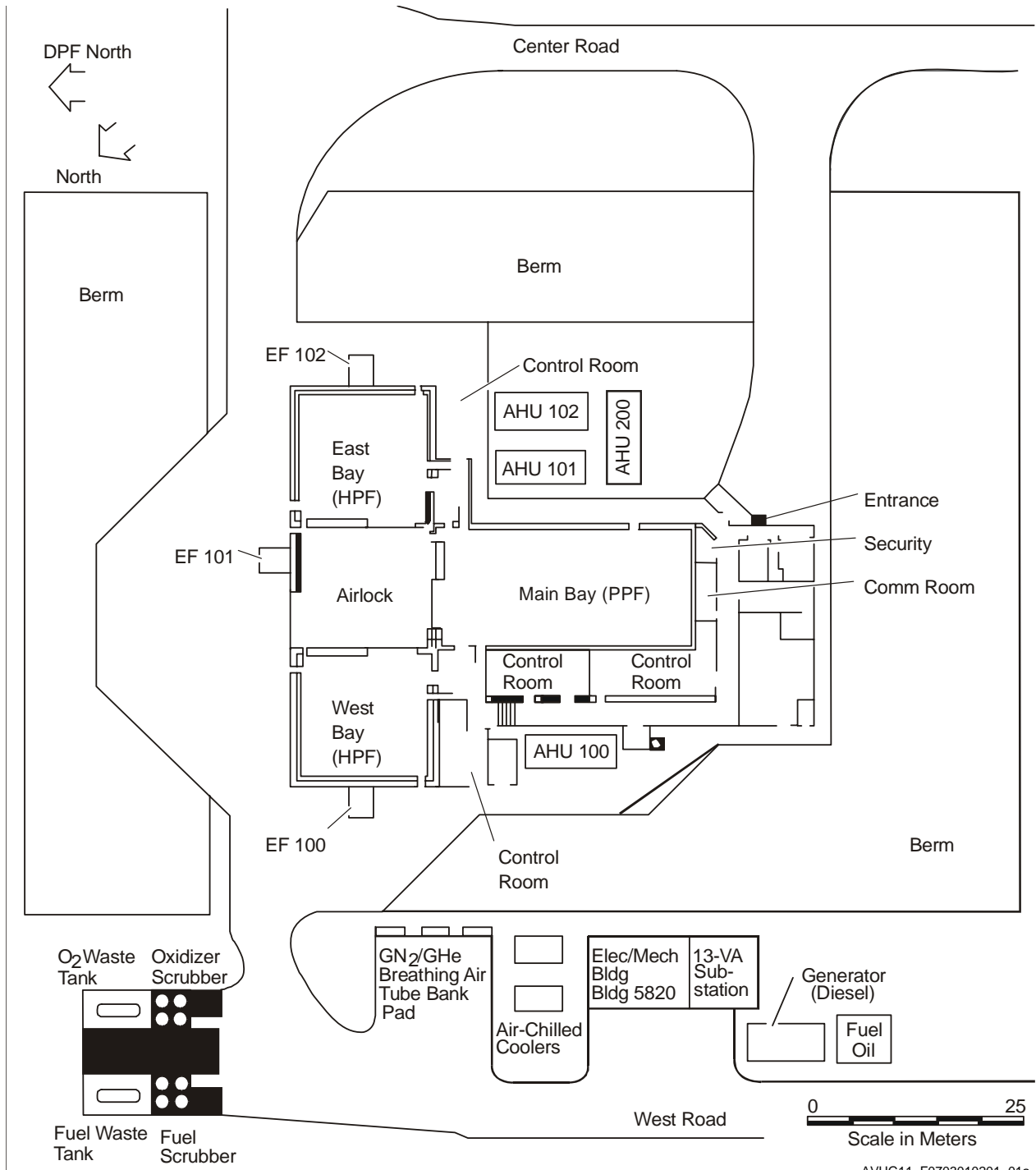


Figure 7.3.1.2.1-2: DPF Area Detail Site Plan



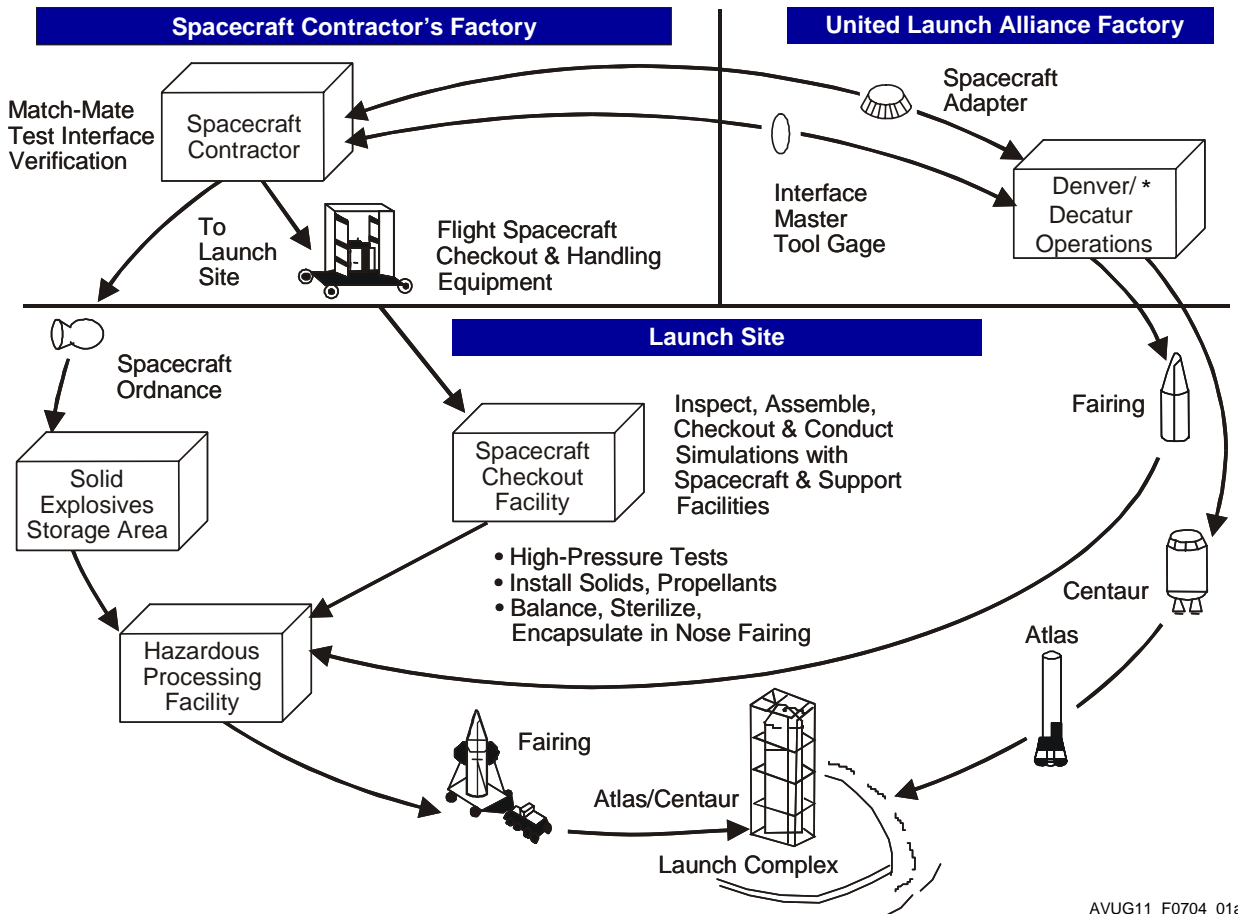
AVUG11\_F0703010201\_01a



### 7.4 VEHICLE INTEGRATION AND SITE PREPARATION

ULA provides complete vehicle integration and launch services for its customers. A system of facilities, equipment, and personnel trained in LV/SC integration and launch operations is in place. The following sections summarize the types of support and services available. Figure 7.4-1 shows a typical factory-to-launch operations flow. Figures 7.4-2 and 7.4-3 depict the operational flow for CCAFS and VAFB respectively.

Figure 7.4-1: Typical Factory-to-Launch Operations



AVUG11\_F0704\_01a

\* See Section A.3 for future Atlas and Centaur production operations.

Figure 7.4-2 CCAFS Operational Flow

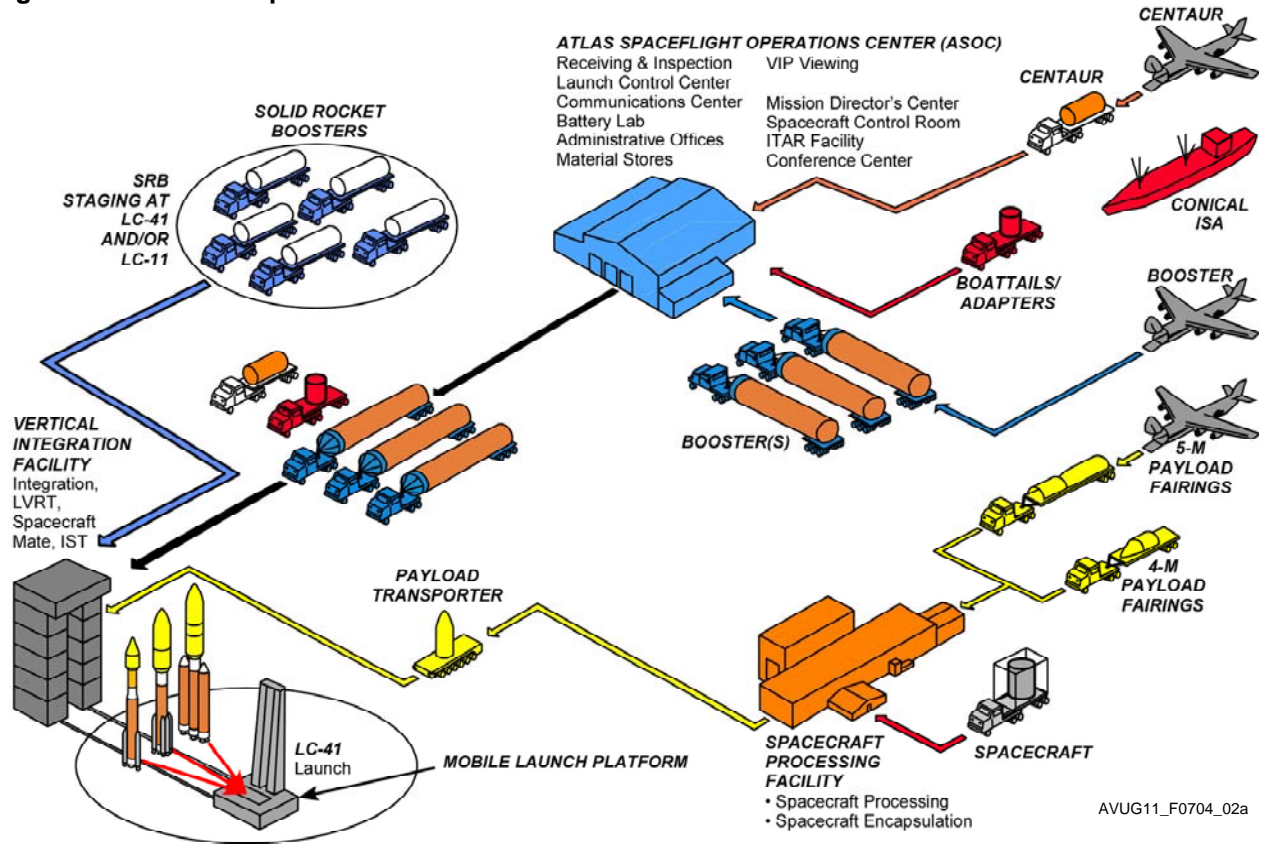
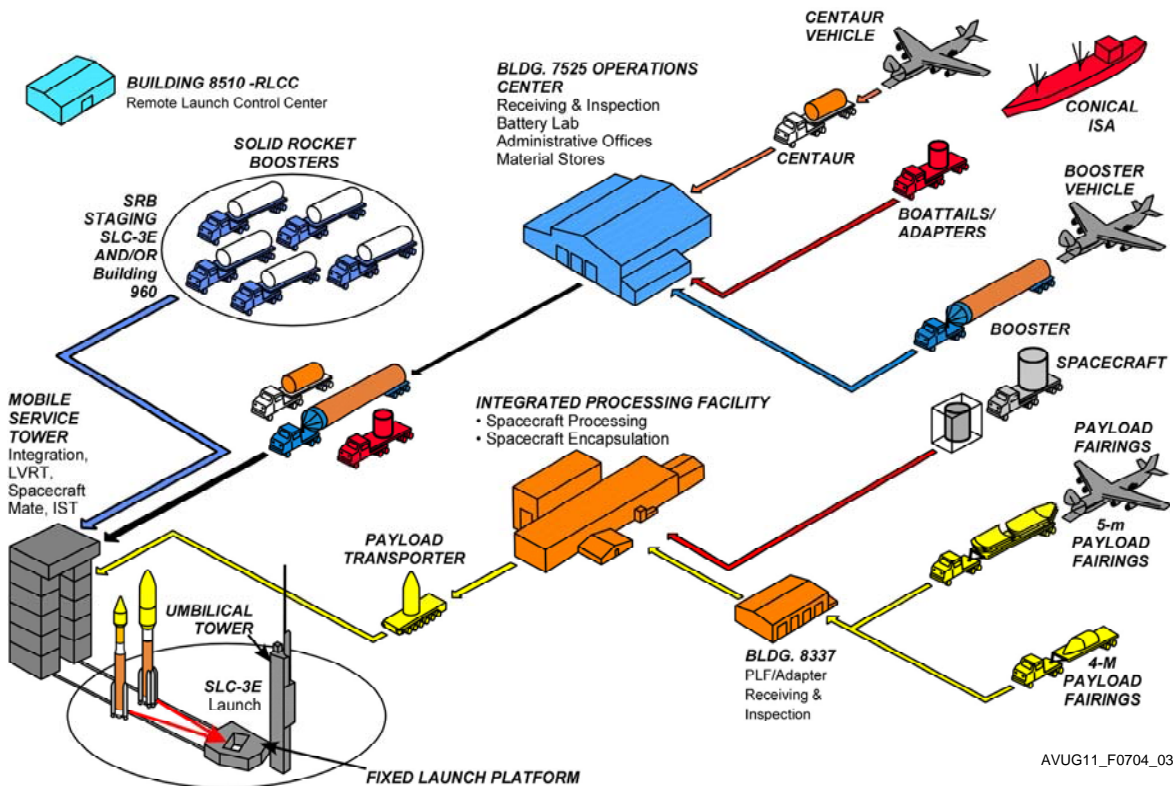


Figure 7.4-3 VAFB Operational Flow



### 7.4.1 Launch Vehicle and Spacecraft Integration

ULA performs LV/SC integration and interface verification testing. Testing for standard and mission unique integration efforts including:

1. Matchmate testing of interface hardware at the SC contractor's facility
  - a. Prototype items
    - i) For early verification of design
    - ii) For accessibility to install equipment
    - iii) For development of handling/installation procedures
  - b. Flight items
    - i) For verification of critical mating interfaces before hardware delivery to launch site
    - ii) Separation system installation
    - iii) Bolt hole pattern alignments and indexing
    - iv) Mating surface flatness checks
    - v) Electrical conductivity checks
    - vi) Electrical harness cable lengths
    - vii) Electrical connector mechanical interface compatibilities
    - viii) Purge system alignment, if required

A matchmate at the SC contractor's facility is required for all first-of-a-kind SC. For follow-on and second-of-a-kind SC, matchmates are optional based on experience with the SC and may be performed at the launch site, if required.

All low shock payload separation system installations will be performed per ULA process utilizing a Payload Mate Fixture.

2. Avionics/electrical system interface testing in the Systems Integration Laboratory, using a SC simulator or prototype test items for verifying functional compatibility:
  - a. Data/instrumentation interfaces
  - b. Flight control signal interfaces
  - c. Pyrotechnic signal interfaces
3. Special development tests at the launch site
  - a. SC data flow tests at launch pad (to verify SC mission peculiar command, control, and/or data return circuits, both hardline and/or RF)

- b. Electromagnetic Compatibility (EMC) testing at the launch pad (to verify SC, LV, and launch pad combined EMC compatibility)

#### **7.4.2 Standard Launch Services**

In addition to its basic responsibilities for Atlas V design, manufacture, checkout, and launch, ULA offers the following operations integration and documentation services for prelaunch and launch operations:

1. Launch site operations support
  - a. Prelaunch preparation of the ULA-supplied payload adapter (PLA), PLF, and other SC support hardware
  - b. Transport of the encapsulated SC and mating of the encapsulated assembly to the LV
  - c. Support of LV/SC interface tests
  - d. Support of SC on-stand launch readiness tests (if requested)
  - e. Prepare for and conduct the joint launch countdown
2. Provide basic facility services and assistance in installation of SC ground support equipment at the launch site
  - a. Installation of SC power, instrumentation, and control equipment in the LSB or PVan and LOC
  - b. Provision of electrical power, water, GHe and GN<sub>2</sub>, long-run cable circuits, and on-stand communications in accordance with the current approved mission Interface Control Document (ICD); Launch Site Integrator will review the SC requirements to current capabilities and determine if the requirement is mission unique and coordinate with Denver Engineering Integration Manager and the SC customer
  - c. Supply of on-stand SC air conditioning within capability of current Environmental Control System (ECS)
  - d. Provision of a spacecraft RF reradiate system in the Umbilical Tower (UT) /Mobile Launch Platform (/MLP) mast (permitting on-stand spacecraft RF testing)
3. Coordination, preparation, and maintenance of required range support documents:
  - a. Air Force Space Command documents, as required, whenever support by any element of the Air Force Satellite Control Network (AFSCN) is requested, including the Operations Requirements Document (ORD), which details all requirements for support from the AFSCN Remote Tracking Stations (RTS) and/or Satellite Test Center (STC) during on-orbit flight operations
  - b. Range ground safety and flight safety documentation as required by the launch site Range Safety regulation and the Federal Aviation Authority (FAA)
    - i) Missile System Prelaunch Safety Package (MSPSP), which provides detailed technical data on all LV and SC hazardous items, forming the basis for launch site approval of hazardous ground operations at the launch site
    - ii) Flight data safety package, which compiles detailed trajectory and vehicle performance data (nominal and dispersed trajectories, instantaneous impact data, 3-sigma maximum turn rate data, etc.), forming the basis for launch site approval of mission-unique targeted trajectory

- iii) FAA launch license (for commercial missions), which includes items 3.b.i and 3.b.ii above as well as overviews of hazardous SC commodities (propellants, pressure systems, etc.); the baseline FAA license is updated to address each commercial mission
- 4. Flight status reporting during launch ascent, which is real-time data processing of upper-stage flight telemetry data:
  - a. Mark event voice callouts of major flight events throughout launch ascent
  - b. Orbital parameters of attained parking and transfer orbits (from upper-stage guidance data)
  - c. Confirmation of SC separation, time of separation, and SC state vector at separation
- 5. Transmission of SC data via Centaur telemetry (an option), which interleaves a limited amount of SC data into the upper-stage telemetry format and downlinks it as part of the upper-stage flight data stream
- 6. Post-flight processing of LV flight data, which provide quick-look and final flight evaluation reports of selected flight data on a timeline and quantitative basis, as negotiated with the customer

**Table 7.4.3-1: Hypergolic Propellants — CCAFS Fuel Storage Depot**

Propellant, Hydrazine, Standard Grade, MIL-P-26536
Propellant, Hydrazine, Monopropellant Grade, MIL-P-26536
Propellant, Hydrazine/Unsymmetrical-Dimethylhydrazine, MIL-P-27402
Monopropellant, High Purity Hydrazine, MIL-P-26536
Propellant, Monomethylhydrazine, MIL-P-27404
Propellant, Unsymmetrical -Dimethylhydrazine, MIL-P-25604
Propellant, Nitrogen Tetroxide (N <sub>2</sub> O <sub>4</sub> ), NAS3620
Propellant, Nitrogen Tetroxide (MON-1), NAS3620
Propellant, Nitrogen Tetroxide (MON-3), NAS3620
Propellant, Mixed Oxides of Nitrogen (MON-10), MIL-P-27408
Propellant, Nitrogen Tetroxide (MON-3, Low Iron), NAS3620

**7.4.3 Propellants, Gases, and Ordnance**

All chemicals used will comply with the requirements restricting ozone-depleting chemicals. Minor quantities of GN<sub>2</sub>, Liquid Nitrogen (LN<sub>2</sub>), GHe, isopropyl alcohol, and deionized water are provided before propellant loading. A hazardous materials disposal service is also provided. SC propellants are available at the Cape Canaveral Air Force Station (CCAFS) fuel storage depot. The U.S. national aerospace standards and U.S. military specification that they meet are described in Table 7.4.3-1. Similar services are available at Vandenberg Air Force Base (VAFB). All propellants required by the SC must comply and be handled in compliance with these standards:

- 1. **Sampling and Handling** — Analysis of fluid and gas samples is provided as specified in the ICD
- 2. **Propellant Handling and Storage** — Short-term storage and delivery of SC propellants to the Hazardous Processing Facility (HPF)
- 3. **Ordnance Storage, Handling, and Test** — SC ordnance and solid motor receiving inspection, bridge wire check, leak test, motor buildup, motor cold soak, safe and arm check, x-ray, and delivery to HPF. Flight units may be stored for about 3 months and spares may be stored for up to 6 months. Other long-term storage is provided on a space-available basis and must be arranged in advance. In addition, a safe facility is available for test and checkout (receiving, inspection, and lot verification testing) of ordnance devices.

### 7.5 INTEGRATED TEST PLAN

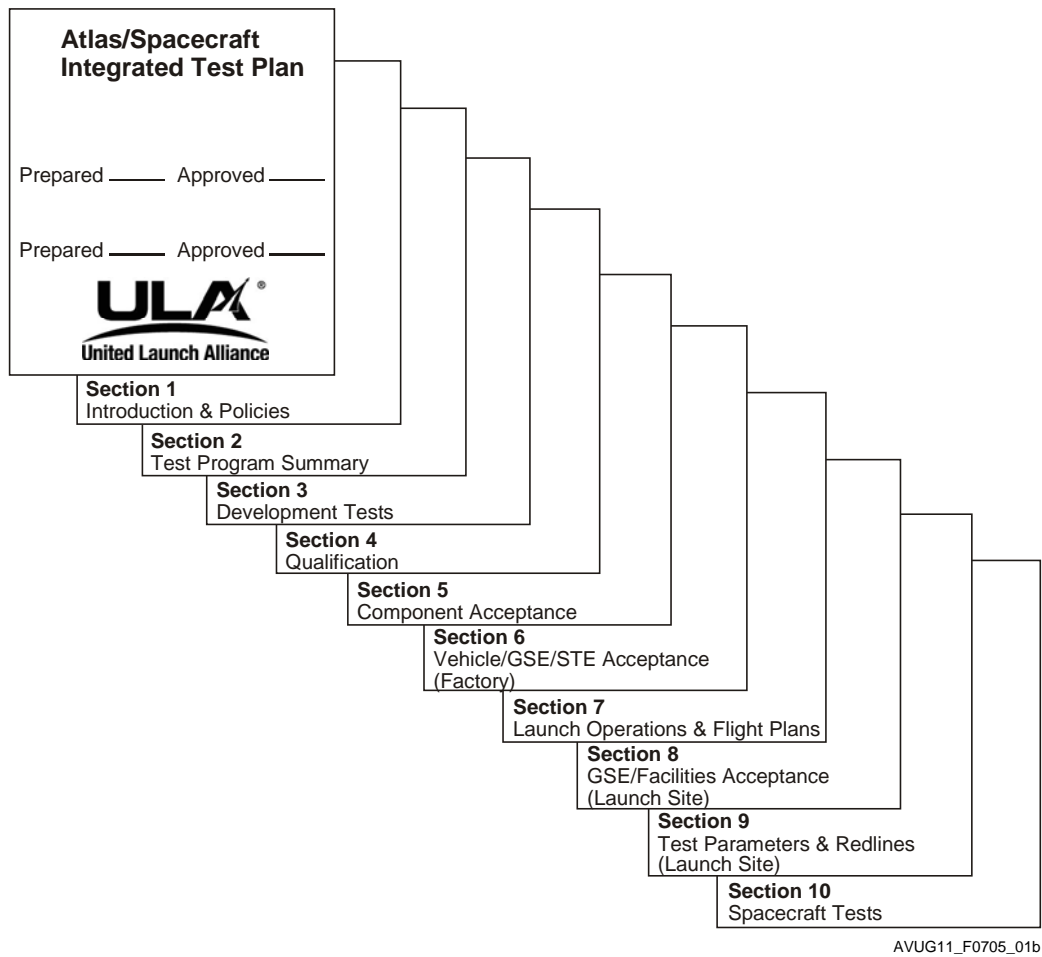
All testing performed during Atlas V design, development, manufacture, launch site checkout, and launch operations is planned and controlled through the Atlas V Integrated Test Plan (ITP). This encompasses all LV testing, including SC mission-peculiar equipment and LV/SC integrated tests. The ITP is administered and maintained within the Parameter Signal Measurement database (PSM) and is available electronically across ULA.

The ITP documents all phases of testing in an organized, structured format. It provides the visibility necessary to formulate an integrated test program that satisfies overall technical requirements and provides a management tool to control test program implementation.

The ITP consists of an introductory section (defining test concepts, philosophy, and management policies), a summary section (providing a system-by-system listing of all tests, requirements, and constraints for hardware development), and seven sections designated for seven different phases of testing (e.g., design evaluation, qualification, components, flight acceptance, launch site) (Figure 7.5-1).

Subsections within these headings consist of the individual test plans for each Atlas V component, system, and integrated system, and provide detailed test requirements and parameters necessary to achieve desired test objectives. Each subsection is issued as a unique standalone document, permitting its review, approval, and implementation to be accomplished independently from the parent document.

Figure 7.5-1: Integrated Test Plan Organization



## 7.6 TEST PROCEDURES

All test operations are performed according to documented test procedures prepared by test operations personnel using the approved ITP subsections together with engineering drawings and specifications. The procedures for testing of Atlas V flight hardware are formally reviewed, approved, and released before testing. The procedures are verified as properly performed by inspection and made a part of each vehicle's permanent history file for determining acceptance for flight and final launch readiness. All ULA procedures are electronically stored and maintained within the Electronic Portable Information Collection system (EPIC), which will be replaced by the Online Rocket Build Inspection and Test System (ORBITS) in late 2010.

Test procedures are documents for SC mission-unique hardware and joint launch vehicle/spacecraft integrated tests and operations. Customers are urged to discuss their requirements with United Launch Alliance early in the mission planning phase so that the various interface and hardware tests can be identified and planned. Customer personnel review and provide comments to mission peculiar test procedures and participate as required in LV/SC integrated tests.

## 7.7 ATLAS V LAUNCH VEHICLE VERIFICATION TASKS

The following paragraphs summarize the typical sequence of tests and activities performed during manufacture, prelaunch checkout, major launch readiness operations, and launch countdown of the Atlas V LV.

### 7.7.1 Factory Tests

Flight vehicle acceptance (or factory) tests occur after final assembly is complete. Functional testing typically takes place at the system level: low-pressure and leak checks of propellant tanks and intermediate bulkhead, checkout of propellant-level sensing probes, verification of electrical harnesses, and high-pressure pneumatic checks.

### 7.7.2 Atlas V Launch Site Prelaunch Operations

After erection of the Atlas V and connection of ground umbilical lines, subsystem and system level tests are performed to verify compatibility between airborne systems and associated ground support equipment in preparation for subsequent integrated system tests.

The PLF halves and payload adapter are prepared for SC encapsulation in the SPF at CCAFS or in the IPF or PPF at VAFB (Figure 7.7.2-1). Major tests are performed before the LV and launch pad are prepared to accept the SC and start integrated operations.

**Launch Vehicle Readiness Test** — The Launch Vehicle Readiness Test (LVRT), the first major LV test within the VIF at CCAFS or the MST at VAFB, verifies that the LV (complete, less the SC and PLF) ground and airborne systems are compatible and capable of proper integrated system operation throughout a simulated launch countdown and plus-count flight sequence. Systems verified include Flight Termination System (FTS), ordnance staging, flight controls, RF, and engine hydraulics/alignment.

**Wet Dress Rehearsal** — The Wet Dress Rehearsal (WDR) consists of performing countdown, cryogenic tanking, abort, recycle, cryogenic detanking, and pad reentry procedures.

### 7.7.3 Atlas V Integrated Operations

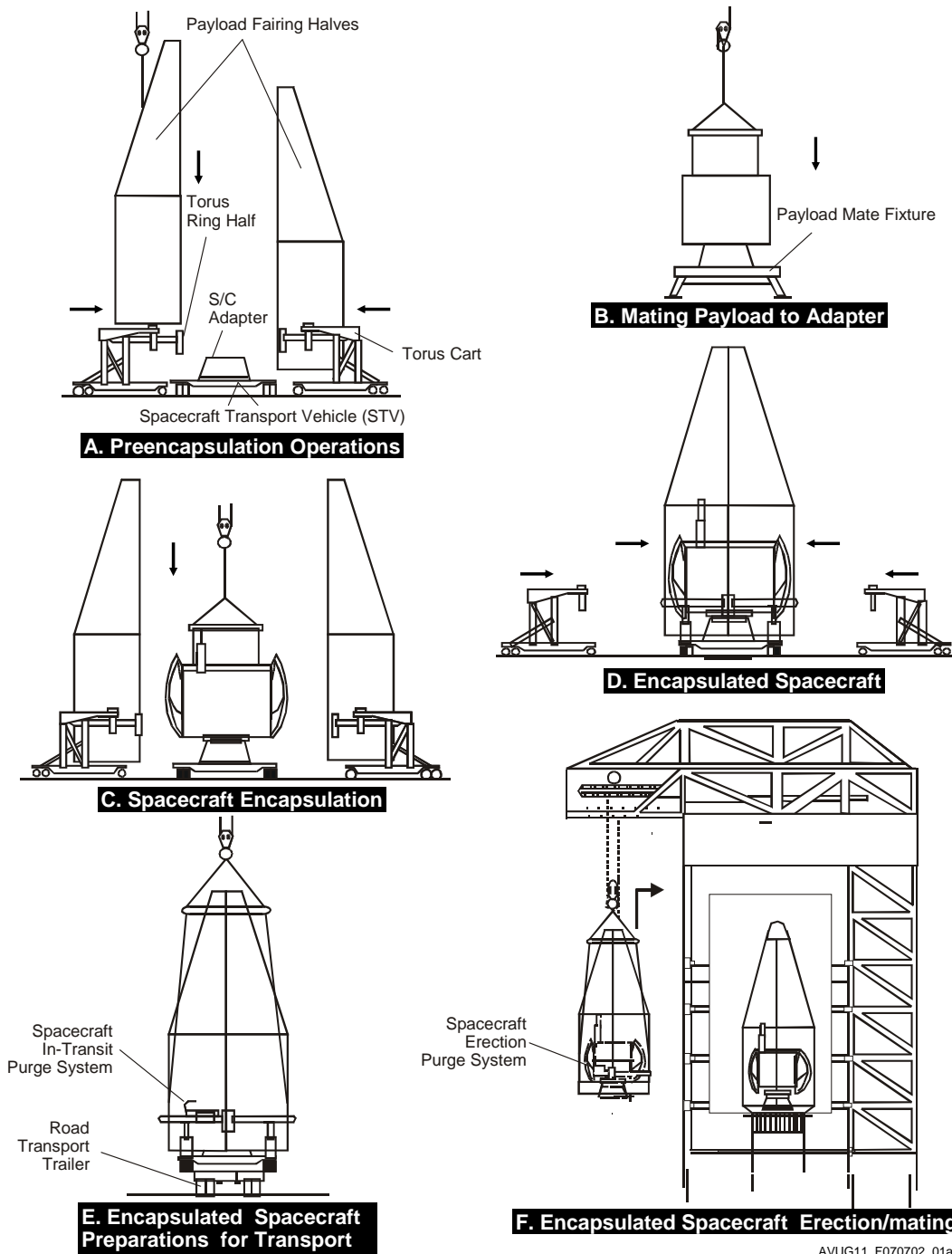
#### 7.7.3.1 Encapsulated Spacecraft Hoist/Mate

After a successful LVRT, the LV and the complex are prepared to accept the encapsulated SC and start integrated operations. After arrival at the launch complex, the encapsulated SC assembly is positioned for hoisting onto the Atlas V LV. Gas conditioning is transferred from the portable unit used during encapsulated

SC transport, to a facility source or GN<sub>2</sub> during hoisting operations. A hoisting sling is fastened to the encapsulated assembly lifting fixture and tie-downs to the ground transport vehicle are released. The encapsulated SC assembly is then lifted into the VIF or MST and lowered onto the Atlas V LV.

After mechanical attachment of the SC and PLF to the LV, the lifting fixture is removed, necessitating a temporary detachment of the gas-conditioning duct. Electrical connections between the payload adapter and the LV are mated to complete the operation.

Figure 7.7.2-1: 4-m Payload Fairing Mate and Spacecraft Encapsulation (5-m Process is Similar)



AVUG11\_F070702\_01a



### 7.7.3.2 Postmate Functional Tests

The SC customer may perform limited SC functional tests shortly after SC mating. These tests verify SC/LV/launch complex/RF interfaces before initiation of more extensive SC testing. Included as an integral part of these checks is a verification of the SC launch umbilical and the SC flight harness routed to the Atlas V standard electrical interface panel. The main operations performed during SC testing at the VIF or MST are:

1. Umbilical and RF S-band, C-band, and/or K-band link checks (without SC)
2. SC batteries trickle charge
3. Telemetry/Telecommand operations in hard-line telemetry configuration
4. Telemetry/Telecommand operations in RF configuration (using a reradiation system)
5. SC flight configuration verifications;
6. SC/ground stations end-to-end test
7. Stray voltage test with the LV

### 7.7.3.3 Postmate Special Tests

Special SC tests may be necessary to investigate anomalies occurring in planned tests or operations, to re-verify equipment operation or performance after changes were made to correct anomalies or to accommodate SC launch site schedules or operations planning. All special tests are conducted according to written and approved test procedures. For example, the SC contractor may perform an operational SC practice countdown to verify SC timelines and coordinate United Launch Alliance support during final launch preparations. In some instances, a customer-provided SC simulator may be required to validate electrical interfaces, SC communications, and SC GSE before mating the encapsulated SC with the LV.

### 7.7.3.4 Integrated System Test

ULA performs the Integrated System Test (IST) with the SC before moving to launch configuration and launch countdown. The SC contractor provides input to the test procedure and participates in the test. Figure 7.7.3.4-1 depicts an IST flow. This test exercises key elements of the countdown sequence arranged on an abbreviated timeline and validates EMI/EMC compatibility.

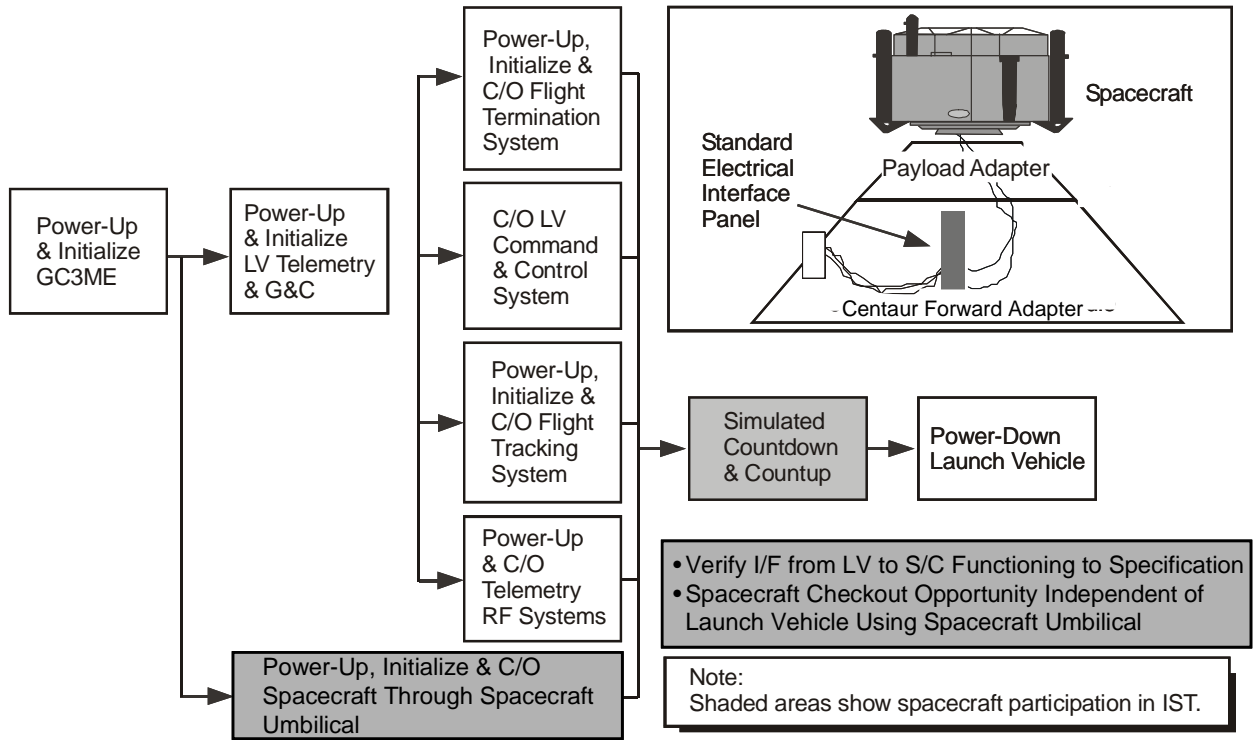
**Purpose** — “Test Like You Fly.” To provide a launch readiness verification of LV ground and airborne electrical systems (with a minimum of systems violations) after reconnection of ground umbilicals, after mating of the flight SC assembly, and before pyrotechnic connection for launch. This is the final Electromagnetic Interference (EMI) compatibility test between the SC and LV. CCAFS Atlas does not typically use IST as a learning event for SC personnel. SC personnel either have a stand-alone rehearsal or ULA is contracted to support rehearsals.

**Test Configuration** — The Atlas V LV is in flight configuration within the VIF or MST, except for pyrotechnics and main propellants. All batteries are simulated by support equipment prior to IST, which will generally use flight batteries. The SC is mated in the launch configuration, including pyrotechnics, propellants, and batteries. SC test and control support equipment is installed in the PVan at CCAFS or in the LSB at VAFB.

**Test Conditions** — All LV umbilicals remain connected throughout the test. Vehicle power to the booster and Centaur is provided by airborne power. All LV electro-explosive devices are simulated by squib simulators. Atlas/Centaur telemetry, FTS, and C-band RF systems are closed-loop tested. The SC is afforded the opportunity to radiate open loop through reradiate system during this test, if required. This test is

conducted from the LCC and uses the full set of Ground, Command, Control, and Communications (GC<sup>3</sup>) systems.

Figure 7.7.3.4-1: Integrated System Test Flow



AVUG11\_F07070304\_01a

**Test Description** — Atlas V electronic systems operate through an abbreviated launch countdown that includes a vehicle flight control end-to-end steering test. A simulated flight sequence test is performed. All pyrotechnic signals are generated and each associated airborne and ground pyrotechnic circuit is monitored for proper response. Centaur tank pressurization, engine valve actuation, prestart, and start phases are monitored for proper vehicle responses. SC participation is not required during the initial portions of the test, and no restrictions are imposed on SC activity. SC and SC launch team participation begins approximately 4 hours into the test. The SC should be configured, as it will be on launch day, at the T-5 hour point. The test continues through an abbreviated countdown, and a nominal “plus” count, terminating at the separation command, and Contamination and Collision Avoidance Maneuvers (CCAM). At conclusion of the plus count demonstration, the avionics and RF systems as well as SC are configured for “power on” stray volts testing through the ordnance simulators. Following this sequence, SC participation in the IST is no longer required, and SC testing and launch preparations may continue. A post-test critique takes place at the completion of the test.

**7.7.3.5 Final Closeouts**

Activities to be performed during final closeouts consist of final preparations necessary to ready the LV, SC, and launch complex for start of launch day activities. Because many tasks are hazardous (e.g., limiting pad access, RF transmissions) and/or are prerequisites to others, they are organized on an integrated basis with their sequence and timeliness controlled by launch pre-countdown operations procedures.

**Installation of Pyrotechnics** — An RF-silence period will be imposed during which mechanical installation/connection of LV pyrotechnics will be performed. SC and associated GSE must be off during these operations.

**Vehicle Compartment Closeout** — After connection of pyrotechnics, personnel prepare the vehicle compartments for launch. Activities include final visual checks, final hardware configurations/remove-before-flight items, internal platform removal, closeout photographs, and airborne door installations.

**Vehicle and Facility Preparations for Roll to Pad (CCAFS Only)** — As vehicle compartments are readied for launch, the LV-to-MLP mast ground umbilicals/lanyards are configured for roll/flight. The VIF platforms, pad, and transport GSE are configured for transport.

### 7.7.3.6 Launch Day Operations

**CCAFS SLC-41** — The standard launch process transports the integrated LV and SC from the VIF to the launch pad the day before launch designated F-1 Day. F-1 activities include transport of the LV/MLP from the VIF to the pad and securing the PVan and GC3 vans in the Payload Equipment Building (PEB). On launch day (F-0), propellant loading, systems verification test, and launch/plus count can commence. There is an option to transport to the pad on the day-of-launch utilizing a 12-hour countdown; however, this option increases risk to launch-on-time. Figure 7.7.3.6-1 shows the launch countdown timeline for a launch from the SLC-41 complex at CCAFS.

**VAFB SLC-3E** — The countdown for a launch from the SLC-3E facility is a single-day operation. The MST is rolled back prior to cryogenic operations. Figure 7.7.3.6-2 shows the launch countdown timeline for the SLC-3E complex at VAFB.

### 7.7.4 Atlas V Launch Countdown Operations

**Countdown Operations** — The launch day countdown consists of an approximate 7-hour count that includes a built-in hold at T-120 minutes (30 minute hold) and at T-4 minutes (10 minute hold) to enhance the launch-on-time capability.

ULA's launch conductor performs the overall launch countdown for the total vehicle. The launch management is designed for customers, ULA efficiencies, and control elements (Figure 7.7.4-1).

SC operations during the countdown should be controlled by a SC test conductor located either in the launch control facility or at some other SC control center (e.g., in the SC checkout facility) at the option of the SC customer.

ULA prepares the overall countdown procedure for launch of the vehicle. However, the SC customer prepares its own launch countdown procedure for controlling SC operations. The two procedures are then integrated in a manner that satisfies the operations and safety requirements of both. This integration permits task synchronization through status checks at predetermined times early in the count and a complete mesh of operations during the final steps to launch.

#### 7.7.4.1 Spacecraft Data Monitoring After T-4 Minutes

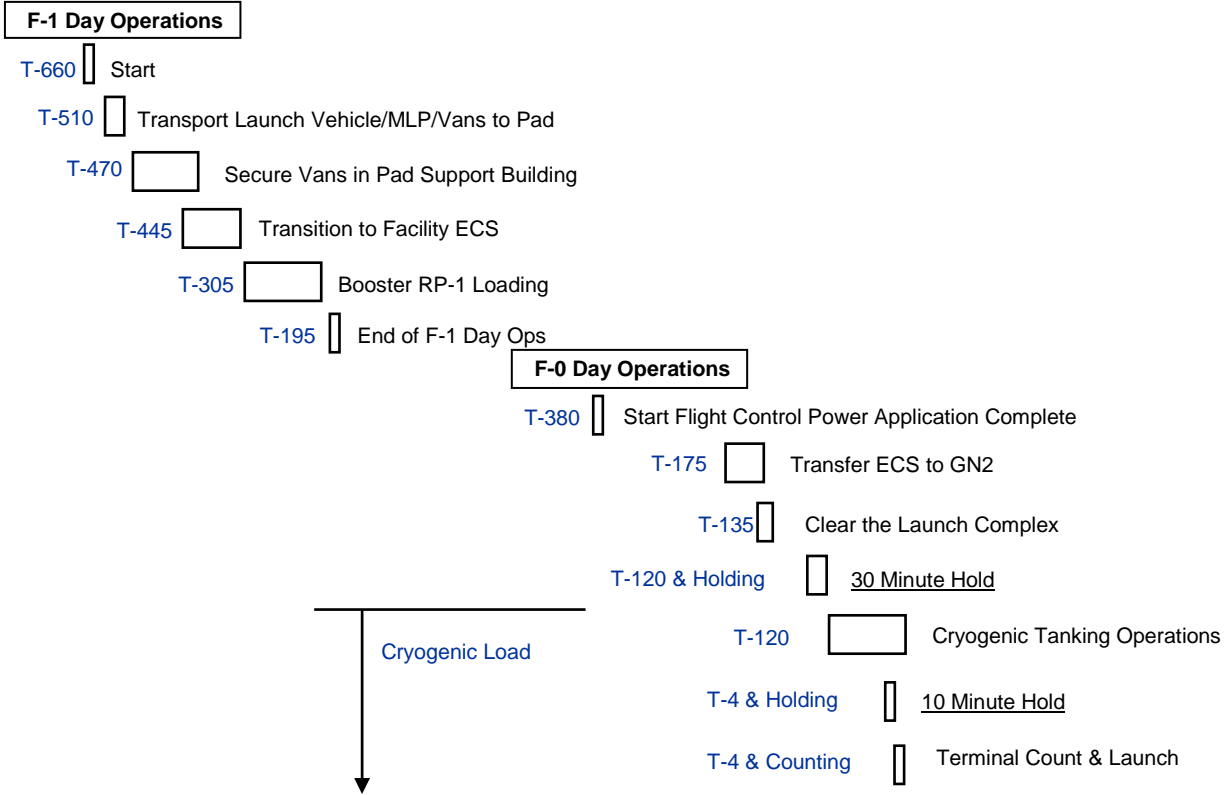
During the terminal count, a minimum of 10 seconds (includes launch conductor response time) is required to accomplish a launch abort prior to initiation of the final launch sequencing. With the potential for significant re-cycle durations and potential risk to the LV and entire integrated stack, after T-4 minutes the Space Vehicle Contractor (SVC) shall:

1. Monitor only critical parameters
2. Use persistence and/or redundant parameters for determining a SC "No-Go" condition

Manual monitoring and associated "Hold" call shall be discontinued at T-10 seconds. In the event the SVC must have the ability to announce hold after T-10 seconds, an evaluation is required to determine if mission unique impacts apply.

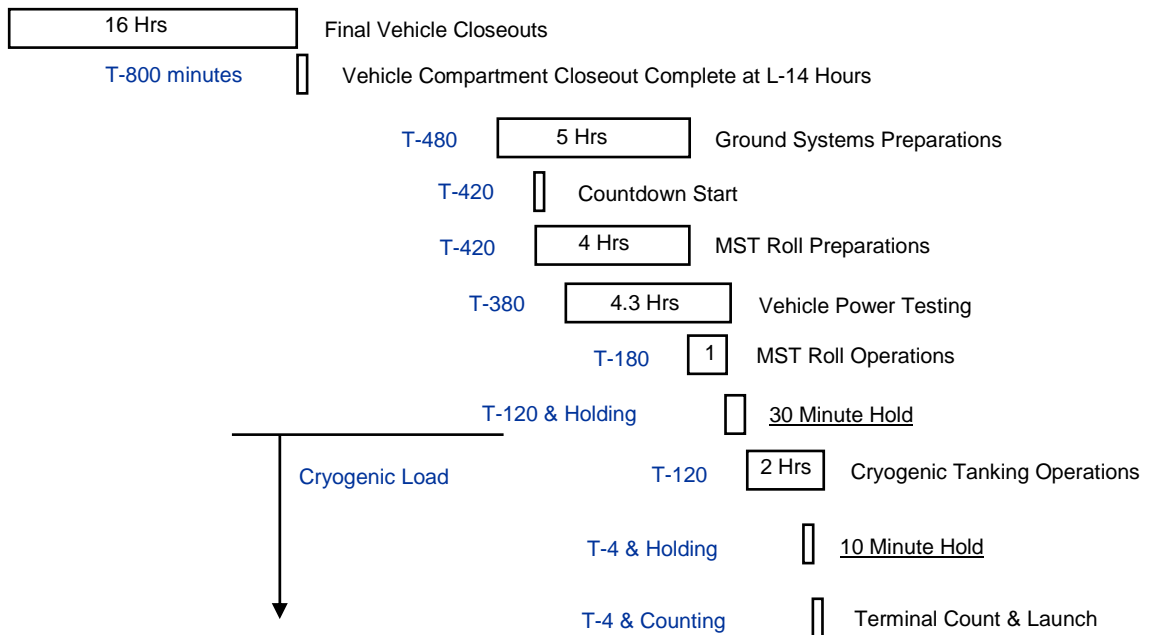
Figure 7.7.3.6-1: Atlas V Launch Countdown — CCAFS

Vehicle Compartment Closeouts Complete F-3 & F-2 Day



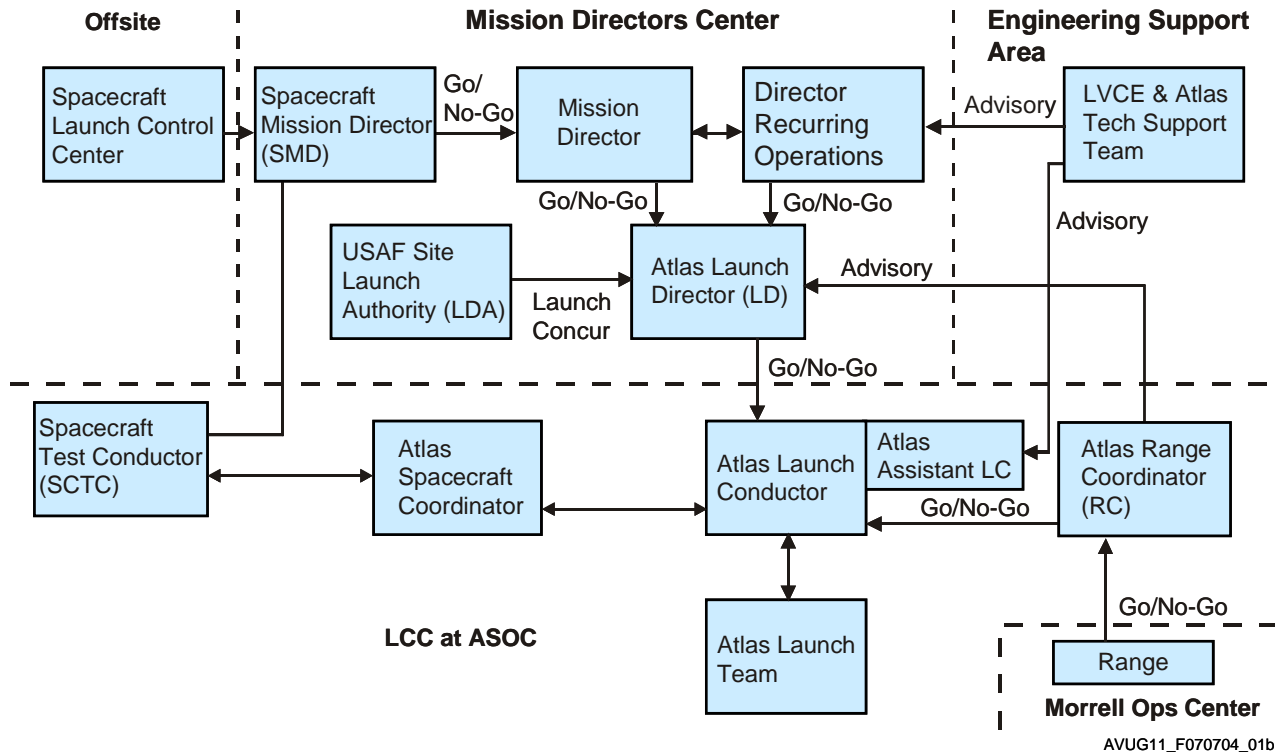
AVUG11\_F07070306\_01d

Figure 7.7.3.6-2: Atlas V Launch Countdown — VAFB



AVUG11\_F07070306\_02a

Figure 7.7.4-1: Typical Atlas V Launch Day Management Flow Diagram



## 7.8 LAUNCH CAPABILITY

In addition to the scheduled holds, additional hold time can be scheduled for up to 2 hours under normal environmental conditions or until the end of the scheduled launch window, whichever comes first. SC mission requirements typically determine launch window restrictions.

## 7.9 WEATHER LAUNCH CONSTRAINTS

In addition to mission-unique launch window restrictions, the decision to launch depends on weather launch constraints. Weather launch constraints include cloud conditions, lightning, thunderstorms, and ground and upper atmosphere winds. Excessive winds during launch may cause overloading of the vehicle structure and control system. Limiting conditions have been well defined and operational approaches developed to ensure launch within safe limits.

The decision to launch may be constrained if significant weather and/or lightning conditions exist in the proximity of the launch site or the planned vehicle flight path at the time of liftoff. The Launch Weather Team must have clear and convincing evidence that the following hazard avoidance criteria are not violated. Even when these criteria are not violated, if any other hazardous condition exists, the Launch Weather Officer (LWO) will report the threat to the Launch Director. The Launch Director may hold at any time based on the instability of the weather.

### 7.9.1 Operational Weather Constraints

#### 7.9.1.1 Weather Constraints

Lightning or equivalent weather conditions within a certain distance from the launch complex require a halt to all pad operations. Range Safety maintains the complete list of lightning constraints. Several general conditions, as identified below, are used in determining operations criteria. The Range maintains specific

caveats as appropriate. This list is included for information only and is not intended to establish the complete list. For the complete list, please refer to the Launch Consol Handbook or contact ULA.

1. Do not launch for 30 minutes after any type of lightning occurs in a thunderstorm if the flight path will carry the vehicle < 10 nm from that thunderstorm
2. Do not launch if the planned flight path will carry the vehicle:
  - a. Within 18 km (10 nmi) of cumulus clouds with tops higher than the -20 °C (-4 °F) level
  - b. Within 9 km (5 nmi) of cumulus clouds with tops higher than the -10 °C (14 °F) level
  - c. Through cumulus clouds with tops warmer than -5 °C (23 °F) or colder than or equal to +5 °C (41 °F)
  - d. Less than 10 nm but greater than 5 nm from any attached anvil cloud for the first 30 minutes after the last lightning discharge in or from the parent cloud or anvil cloud
  - e. Through any debris cloud for 3 hours after the debris cloud is observed to be detached from the parent
  - f. Through any cumulus cloud that has developed from a smoke plume while the cloud is attached to the smoke plume, or for the first 60 minutes after the cumulus cloud is observed to have detached from the smoke plume
  - g. Through any cloud types that extend to altitudes at or above the 0 °C (32 °F) temperature level and are associated with the disturbed weather within 9 km (5 nmi) of the flight path.
3. Do not launch if at any time during the 15 minutes before launch time, the absolute electric field intensity at the ground exceeds 1 kV/m within 9 km (5 nmi) of the planned flight path, unless there are no clouds within 18 km (10 nmi) of the launch site. This rule applies for ranges equipped with a surface electric field mill network.
4. Do not launch if the planned flight path is through a vertically continuous layer of clouds with an overall depth of 1,370 m (4,500 ft) or greater, where any part of the clouds is located between the 0 to -20 °C (32 to -4 °F) temperature levels.
5. Triboelectrification rule is not applicable for Atlas V.
6. Even when criteria are not violated, if any other hazardous condition exists, the Launch Weather Team will report the threat to the Launch Director. The Launch Director may hold at any time based on the instability of the weather.

### 7.9.1.2 Integrated Test Procedure Lightning Retest Criteria

During pre-launch activities, if cloud-to-ground lightning has been detected in the vicinity of the LV, a determination will be made to retest LV components to search for damage. The decision to retest is based on the radial distance from the vehicle that the lightning strike occurred and the magnitude of the strike, in amps. Table 7.9.1.2-1 shows the lightning retest criteria curve. This can also be found in the ITP.

**Table 7.9.1.2-1 Ring Criteria Limit**

SLC-41, ASOC and SLC-3E	
Distance from LV (N Miles)	Magnitude (K Amps)
< 0.625	2
< 1.125	50
< 2.0	100
< 2.875	150
< 3.5	200
< 4.75	300
<5.0	400

### 7.9.2 Ground Winds Monitoring

The Atlas V LV is subject to ground wind restrictions during vehicle hoist, vehicle assembly, VAFB MST rollback, or CCAFS MLP rollout, up through the time of launch. The Atlas V program has an established ground winds restriction procedure that provides limiting wind speeds for all ground winds critical conditions. In addition, the document provides insight into the nature of ground winds loadings and possible courses of action should the wind speed limits be attained. The ground winds restriction procedure also contains limiting wind speeds during Atlas/Centaur erection, hoisting, and encapsulated SC hoisting.

The ground winds monitoring system design allows monitoring of vehicle loads when the LV is exposed on the launch pad prior to launch. This is accomplished by sampling flight rate gyro rotational velocities (pitch and yaw signals), ground winds anemometer speed, ground wind directional azimuth, tanking levels, and tank ullage pressures. Data are processed, providing the ground winds monitor with a ground winds Load Ratio (LR) that represents the maximum load-to-limit allowable ratio in the vehicle or launcher at any given time. In addition, the LR is presented from the Computer-Controlled Launch Set (CCLS) to a ground winds monitor (one person) to evaluate the output data and immediately inform the launch conductor whenever the LR is approaching an out-of-tolerance condition.

### 7.9.3 Flight Wind Restrictions

Most loads experienced by the Atlas V vehicle in flight can be calculated well before the vehicle's launch date. However, one major loading condition induced by the prevailing atmospheric winds (called flight wind profile) must be accounted for just before launch if maximum launch availability and mission success are to be ensured during marginal weather conditions.

On each mission, the pitch and yaw program is designed on launch day based on the actual launch day winds as determined from launch site weather balloon soundings. A computer software program called Automatic Determination and Dissemination of Just Updated Steering Terms (ADDJUST) provides this capability. Specifically, ADDJUST makes it possible to automatically accomplish the following:

1. Design an Atlas V booster phase pitch/yaw program pair based on wind data measured at the launch site during the launch countdown
2. Determine whether the wind profile loads and engine angles violate the vehicle's structural and control constraints
3. Transmit the designed programs to the CCLS computer at the launch site launch control facility (for subsequent loading into the flight computer) with verification of correct transmittal of data

**Wind Sounding Procedure** — Operations begin with the release of weather balloons from the launch range at specific intervals before launch. Raw wind data obtained from each balloon sounding are computer-reduced by range weather personnel to wind speed and direction data.

**ADDJUST Program Procedure** — Launch site wind data are received by computers at United Launch Alliance in Denver, Colorado and automatically verified. The ADDJUST design and verification sequence is then executed. The resulting pitch and yaw program pair designed by ADDJUST is available for transmission back to the launch site approximately 10 minutes after Denver completes reception of the wind data. Pitch and yaw data transfer occurs directly from the Denver computer to the launch site backup CCLS computer. Simultaneously with this transmission, ADDJUST proceeds with loads validation computations, and checks predicted loads and engine angles resulting from the pitch and yaw program design versus vehicle structural and control allowables. This will be followed by an engineering trajectory simulation run to check all trajectory-related parameters.

**Launch Recommendations** — With the ADDJUST-generated programs, all constraints must be satisfied before a “go” recommendation for launch may be made. The ADDJUST designer was developed so that the trajectory-related constraints resulting from the engineering trajectory simulation would be satisfied. While the designer minimizes angle of attack, it cannot design pitch and yaw programs for a specific chosen set of loads.

**7.10 LAUNCH POSTPONEMENTS**

The following describes launch postponement for late abort scenarios and safety constraints. Section 7.7.4.1 discusses SC data monitoring and hold constraints.

**7.10.1 Launch Abort Recycle Capability**

Table 7.10.1-1 provides the launch abort recycle capability.

**7.10.2 Safety COLA Constraints**

Portions of the launch window may not be available due to a safety Collision Avoidance (COLA) closure. The USAF Range Safety Organization in conjunction with the Joint Space Operations Center (JSpOC), performs the safety COLA analysis. The analysis examines the ULA provided trajectory (from liftoff through approximately 2 hours after spacecraft separation for both the launch vehicle and the spacecraft) including launch window effects to determine if there is a potential for the LV or SC to collide (a conjunction) with any object in the JSpOC catalog. This catalog includes manned objects or objects capable of being manned (such as the International Space Station or Space Shuttle), active satellites and debris. Launch periods that would result in a high probability of conjunction at any time in the trajectory are identified and excluded from the daily launch window. Safety COLA analyses are completed at L-7 days, L-3 days, and L-6 hours with the L-6 hour analysis used to establish the final safety COLA closures for launch day.

**Table 7.10.1-1 Launch Abort Recycle Capability**

T-Time	Event	Impact/Minimum Recycle Time
Prior to T-4 min & Counting	Preps or Cryo Tanking	Extend Hold Time as Required to Work Issues. Can Safely Remain in T-4 Min Hold Until End of Window.
T-4 min & Counting	Pickup Terminal Count	Required LV reset/recycle & poll launch team. 15 Minutes to Recycle (Approx.)
T-8 sec	Go Inertial	Realign FTINU. 60-minutes Minimum Recycle
T-7 sec	Vent Door Firing	Scrub for the day. Must replace Vent Door pyro pin puller. 48-hour Recycle Minimum
T-5 sec	Pull Aft Plate	Scrub for the Day. Must Replace Centaur Tank Pressurization & CEC Pyro Isolation Valves. This is Off Nominal Abort Processing. 72-hour Recycle Minimum
T-2.72 sec & After	RD180 Start Bottle Press	Hot Fire Abort. Scrub for the Day. Same Steps & Concerns As Above Plus RD-180 Readiness Tasks. 11-days Recycle Minimum



## 8. FUTURE ENHANCEMENTS

This section summarizes several Atlas V launch system enhancements currently planned or in development. These enhancements expand the operational capability of the Atlas V launch vehicle, ensuring competitiveness in the future launch services market. For latest information on enhancements, please contact ULA.

### 8.1 PAYLOAD FAIRINGS

The current Atlas V fleet has 4-m and 5-m diameter payload fairings of various lengths available for customer use as described in Section 6. Should a customer have a unique requirement to accommodate a larger payload, longer and wider payload fairings may be developed. ULA has considered payload fairings as large as 7.2 m (283 in.) in diameter and up to 32.3 m (106 ft long), as shown in Figure 8.1-1. These larger fairings, which are limited to flying on Atlas V configurations of up to four solid rocket boosters (SRBs), require moderate vehicle changes and modifications to the launch pad, limited mostly to secondary vertical processing facility structure. Please contact ULA for additional information on larger fairings.

### 8.2 PERFORMANCE UPGRADES

Since 1957, Atlas has been incrementally enhanced, improving performance, reliability, and responsiveness while reducing operational cost. By segmenting the development steps into focused incremental upgrades, Atlas has been able to continuously and seamlessly upgrade the system while maintaining 100% mission success on all eight new flight configurations since 1990. Leveraging off of this successful history, Atlas has developed an Atlas evolutionary (i.e., spiral) development strategy for future space transportation capabilities that spans and enhances the existing Atlas V performance range. Potential upgrades that are currently being evaluated are discussed below. For additional information, please contact ULA.

#### 8.2.1 Common Upper-Stage

ULA is focused on the development of a Common Upper Stage vehicle, supporting both Atlas V and Delta IV booster configurations, as a mechanism to reduce recurring costs through internal, vendor, and hardware configuration consolidations. Additional benefits include increased mission performance capabilities and enhancement of manifest flexibility.

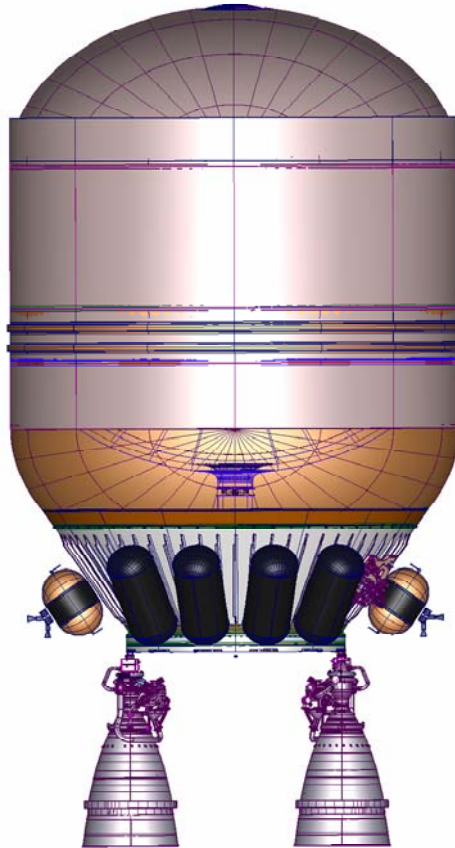
ULA anticipates recurring cost reductions through consolidating multiple upper-stage and PLF configurations into a common vehicle application across both booster product lines, and through vendor reductions due to consolidations, production rate increases, and reductions in solid rocket motors and boosters needed to support intermediate-class configurations is expected to reduce recurring costs. Consolidations of existing product line hardware will be performed across multiple sub-systems (Avionics, Instrumentation, Propulsion and Ordnance) for deployment on existing Centaur and Delta DCSS as well as aligned for implementation on the Common Upper Stage.

Conceptually, the vehicle diameter is 5.1 m (17.2 ft) to accommodate current aluminum production capabilities at our Decatur, Alabama production facility. ULA is evaluating tank configurations to accommodate various materials (Al and CRES) with varying propellant levels from 46,000 lb to 90,000 lb to minimize stage weight and maximize performance capability through extension of the tank sidewall. ULA is considering single engine (SE) and dual engine (DE) capabilities based on mission performance requirements. Figure 8.2.1-1 shows a conceptual diagram of the Common Upper Stage.

Figure 8.1-1: Atlas V with 7.2-m Diameter, 32.3-m Long PLF



Figure 8.2.1-1: Common Upper Stage Concept (Dual Engine)



AVUG11\_F080201\_01c

First-stage configurations remain unchanged; the Common Upper Stage can be used with all current Atlas V and Delta IV configurations. Performance growth for intermediate-class configurations will reduce the number of required SRBs to achieve customer mission requirements, which will result in recurring program cost savings. Table 8.2.1-1 contains performance estimates for various launch vehicle and orbit configurations.

Table 8.2.1-1: Common Upper Stage (Dual-Engine) 90,000 lb Propellant Load Performance

Mission	Atlas V — 55X	Delta IV — M+(5,4)	Delta IV — Heavy
GTO	24,000 lbs	20,000 lbs	>> 27,800 lbs
LEO	45,000 lbs	37,000 lbs	67,000 lbs
GSO	11,500 lbs	8,740 lbs	18,500 lbs

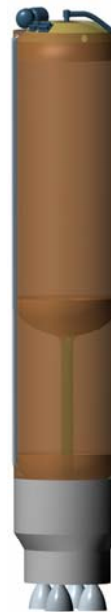
ULA is also evaluating PLF consolidations from five to one or two 5m configuration, with recommendations based on existing design characteristics and the ability to accommodate existing mission-unique mechanical, electrical, and environmental requirements. Additionally, the Common Upper Stage will be extensible to incorporate additional upper-stage engines for LEO heavy lift capability, larger PLF configurations, and long duration missions.

### 8.2.2 Wide-Body Booster

The Wide-Body Booster (WBB) is a follow-on to the Common Upper Stage that would apply the same principles of modularity (combinations of common elements), mission flexibility, and fabrication methodology to a 5.1-m (16.7-ft) diameter booster (Figure 8.2.2-1). The WBB will leverage existing Delta IV booster tooling. The aft thrust structure, plumbing, and support systems are modular to support either one or two RD-180 engines. Adding a second RD-180 provides additional thrust to support heavy mission requirements, while providing engine-out capability during booster phase of flight.

The booster tank volume is designed to be variable (0.9 to 1.7 times Atlas V booster volume) to accommodate diverse mission needs. Through simplified tank design, the booster may accommodate up to six SRBs, resulting in a "single stick" performance in excess of 39 mT to LEO, 40% larger than the conceptual Atlas V HLV. A three-body HLV configuration may provide 86 mT to LEO, approaching Saturn V performance.

Figure 8.2.2-1: Atlas V Wide-Body Booster



5.1-m Diameter Booster Dual RD-180 Capability

- Allows Booster Engine Out

Existing Launch Site Infrastructure

- New Mobile Launch Platform for 3 Body Version



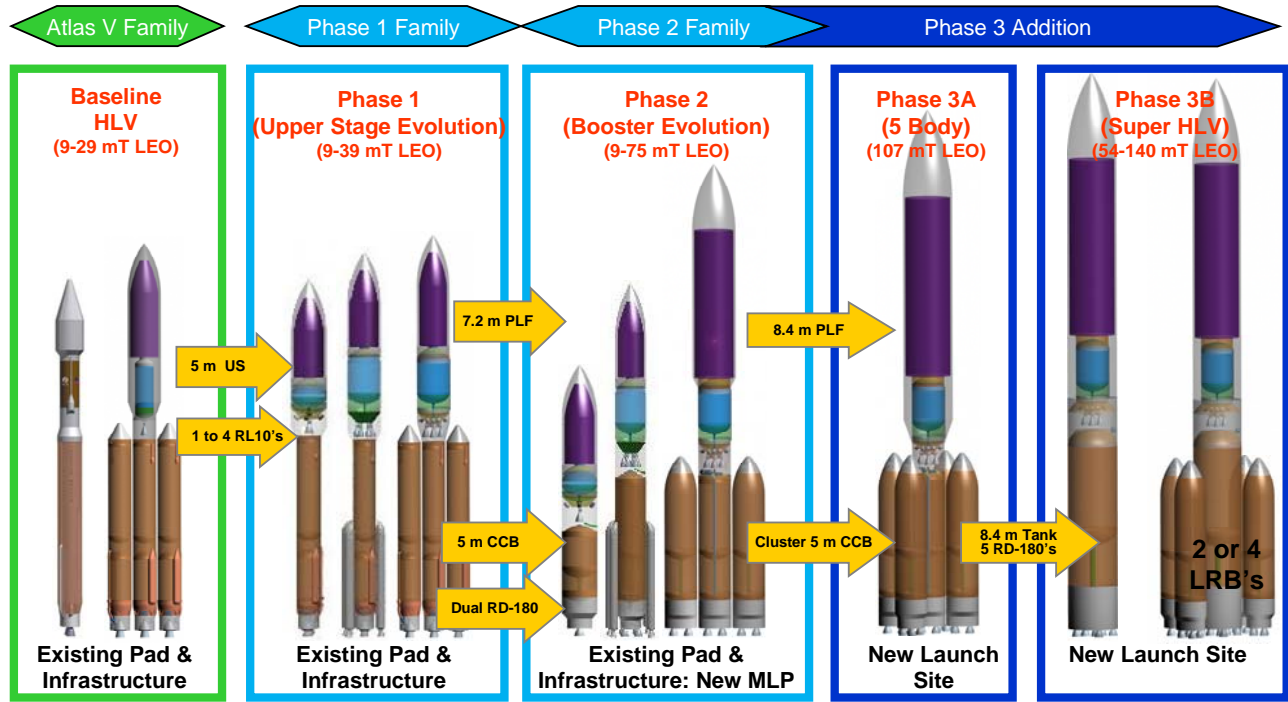
AVUG11\_F080202\_01a

### 8.2.3 Heavy-Lift Evolution

Development of the 5-m diameter evolved upper stage and 5-m diameter booster lay the foundation for further Atlas evolution to support potential growing customer performance requirements. As shown in Figure 8.2.3-1, combinations of these enhanced wide body booster cores with the evolved upper stage can produce a set of affordable heavy-lift solutions that deliver over 100 mT to LEO. Depending on customer requirements, one can either cluster five wide-body boosters to deliver 107 mT to LEO or, if even more performance is required, four wide body boosters can be clustered around an 8.4-m diameter core to deliver 140 mT to LEO. Both of these booster combinations are paired with the evolved upper stage and a new 8.4-m (27.6-ft) payload fairing.

The 5-m diameter booster tank is derived from Delta IV's existing 5-m tank and is powered by a pair of RD-180 engines. The 8.4-m diameter core is derived from the Space Shuttle's external tank and powered by five RD-180 engines. Both the 5-m and 8.4-m diameter booster cores can fly either as a single core, with strap on Aerojet SRBs (1 to 6), or as multi-core combinations with the use of either two or four 5-m, wide-body liquid rocket boosters (LRBs). The single core configurations provide ideal, highly reliable launch vehicles capable of supporting launch of large crew capsules. These super-heavy Atlas derivatives allow Atlas to support a broad payload range (9mT to 140 mT to LEO) with a common vehicle family.

Figure 8.2.3-1: Heavy-Lift Evolution



### 8.3 OTHER ENHANCEMENTS

In addition to payload accommodations and performance improvements, the Atlas V program is developing other concepts to provide additional capabilities to the space community. The following sections describe these concepts.

#### 8.3.1 Centaur Sun Shield

The combination of LO<sub>2</sub> and LH<sub>2</sub> provide the ideal propellants to support in-space transportation due to the high specific impulse (Isp), relative ease of handling, and capability to generate high thrust. However, missions requiring long durations are challenged by the cryogenic nature of these propellants, specifically how to efficiently store and handle them while limiting boil-off. Historically, cryogenic storage has been enabled through the use of multi-layer insulation (MLI). MLI has proven to be quite effective at reducing incident radiation from solar and Earth sources. However, MLI must be protected during launch to avoid aerodynamic forces from ripping the MLI from the vehicle. For systems where the cryogen stage is exposed to the atmosphere during ascent, such as the Atlas V Centaur 4-m PLF vehicle, attaching MLI to the sidewall of the Centaur is not an option. Because the Atlas V 4-m PLF configuration has Centaur its sidewalls exposed to solar radiation, it currently accepts high boil-off rates and the resulting restricted mission durations of less than 3 hours.

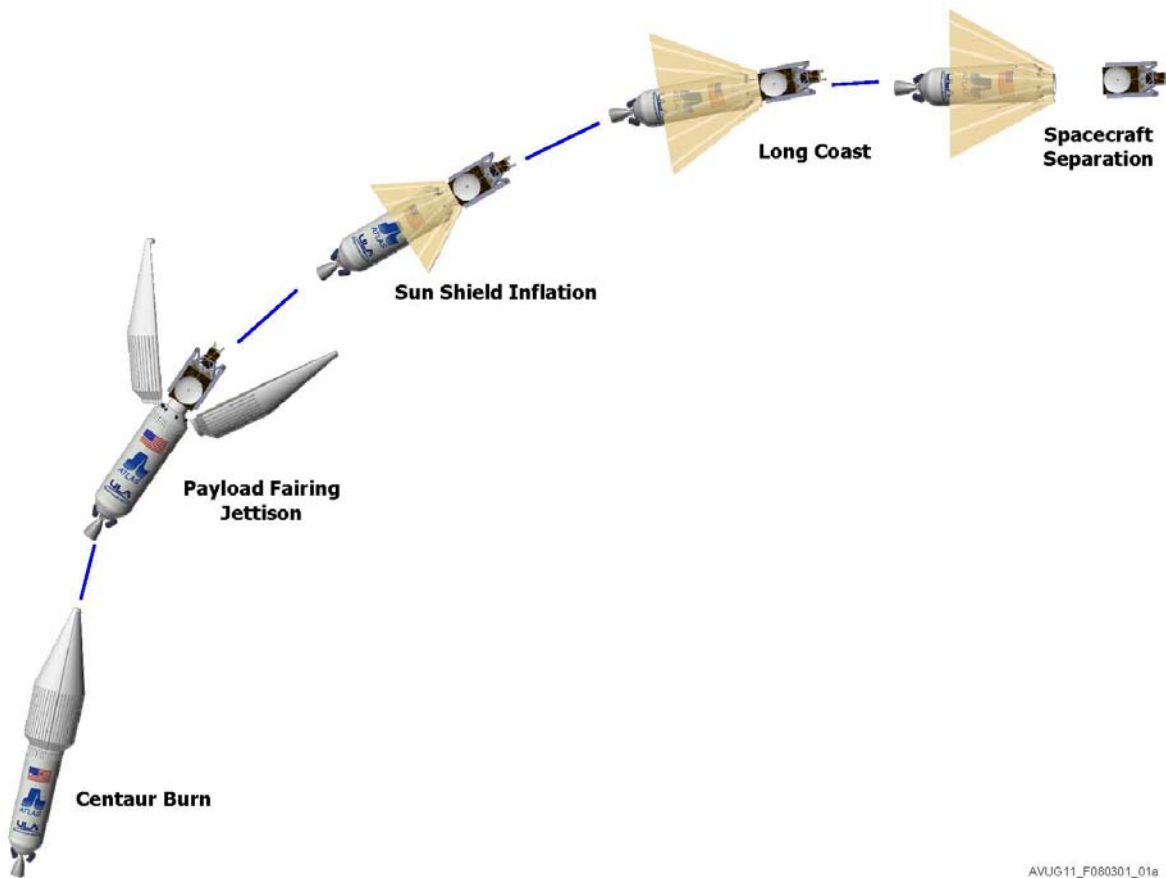
A deployable sun shield provides an alternative method of shielding large cryogenic systems such as the Centaur from solar and Earth radiation. Numerous studies have shown the thermal benefit of a sun shield, either on its own or in combination with MLI. A deployable sun shield would be stowed during ascent and deployed once on-orbit to very effectively insulate the Centaur liquid hydrogen and liquid oxygen tanks.

The sun shield design is a light weight, segmented thermal radiation blanket that launches in a stowed configuration; deploys after payload fairing jettison by the inflation of booms that unfurl the blankets; and surrounds the Centaur's cryogen tank to reduce radiation heat transfer. The Centaur Sun Shield (CSS) is made in six segments that deploy independently to provide reliability and redundancy. A boom located at the

center of each of the six trapezoids inflates independently of the other five. If a single petal fails to deploy, it will not prevent the deployment of the other five as it would if they were all tied together. There are window openings at the forward end of the CSS so that the CFA-mounted components meet their thermal environment requirements. An assembly called a columnator provides for boom stowage in a small package, provides controlled inflation pressure and speed during deployment, and provides root stiffness for the boom to deploy in a straight line.

The CSS will be mounted to a composite stowage ring that is structurally attached to a payload adapter. After payload fairing and booster jettison, and while the Centaur upper stage is not accelerating, the command to deploy the CSS will initiate. All petals will inflate and deploy independently from each other while on-board instrumentation monitors the deployment. The booms and shield assemblies will be designed to withstand vehicle acceleration during subsequent engine burns. The inflated booms will flex during acceleration, and will return to the CSS conic shape after vehicle acceleration is complete. Figure 8.3.1-1 shows the CSS operational stages after booster and payload fairing jettisons.

Figure 8.3.1-1: Centaur Sun Shield Concept of Operations



AVUG-11\_F080301\_01a

Intentionally Left Blank

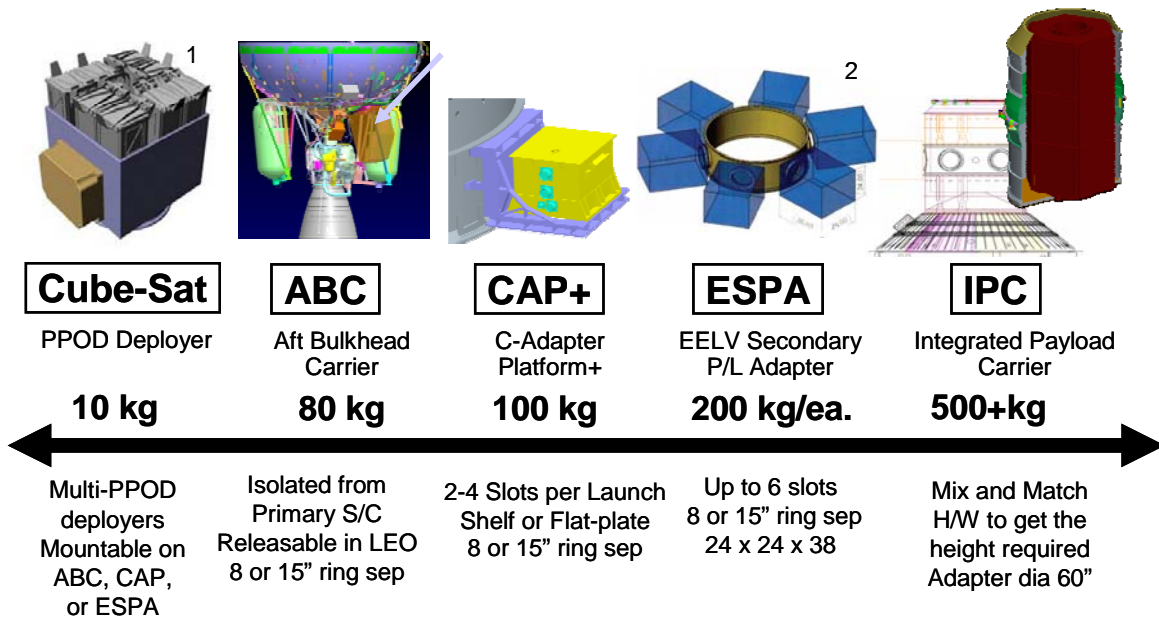


## 9. AUXILIARY AND DUAL PAYLOAD ACCOMODATIONS

### 9.1 AUXILIARY PAYLOADS

United Launch Alliance (ULA) remains committed to supporting the auxiliary spacecraft community. Auxiliary payloads fly as a secondary passenger with a primary payload mission. Figure 9.1-1 shows a spectrum of the Atlas V rideshare accommodations for various classes of auxiliary spacecraft. This section outlines how ULA is fostering frequent and affordable launch services for auxiliary payloads and the capabilities to support a wide range of size and weight payloads. ULA is continually enhancing our rideshare capabilities by working closely with our primary payload and auxiliary payload customers. ULA is actively expanding our auxiliary payloads process and support including identification of rideshare mission opportunities, links to the governing rideshare policies, guidance to the auxiliary spacecraft developer on qualification, certification, and interface specifications. For the latest information regarding the Atlas V auxiliary payload capabilities, please refer to the ULA website at [www.ulalaunch.com](http://www.ulalaunch.com) or contact ULA directly.

Figure 9.1-1: Atlas V Rideshare Accommodations



1 NPSCuL courtesy of Naval Post-Grad School  
 2 ESPA Graphic courtesy of CSA Engineering, Inc

AVUG11\_F0901\_01a

#### 9.1.2 Poly Picosatellite Orbital Deployer

CubeSats are a small class of spacecraft identified by a 10 cm cube volume. A common carrier for this class of spacecraft is the Poly Picosatellite Orbital Deployer (PPOD) developed by Cal Poly University of California. An individual PPOD is by nature a simple device however the effort to integrate a single PPOD is the same as integrating a multi-PPOD deployment system. ULA has taken the position to work with multi-PPOD deployment systems that can be accommodated within the ULA standards and envelope definitions for our standard carrier mechanisms.

The first such system, shown in Figure 9.1.1-1, is the Naval Post Graduate School (NPS) CubeSat Launcher (NPSCuL). The NPSCuL hosts eight (8) PPODs for a total of 24 CubeSat slots. This device has been integrated on the Atlas Launch Vehicle for the Aft Bulkhead Carrier (ABC) system. Similarly, it will also fit as one of the six EELV Secondary Payload Adapter (ESPA) positions. Both the ABC and ESPA systems are described in more detail later in Section 9.

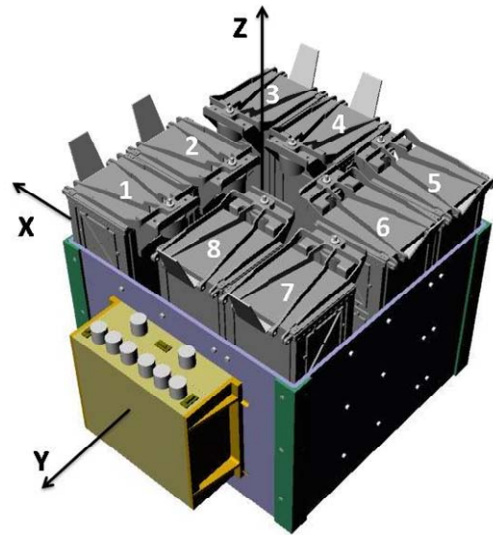
The concept of operations for this system begins with the upper stage entering a coast mode. While the upper stage is quiescent, each PPOD may be deployed individually by Atlas V's avionics system.

### 9.1.3 Aft Bulkhead Carrier

The Aft Bulkhead Carrier (ABC) utilizes volume on the Centaur aft bulkhead previously occupied by a helium bottle that is no longer required. The ABC can carry an auxiliary payload with a mass of up to 80 kg (176 lb). Located on the aft-end of the Centaur main propellant tanks near the RL10 engine area, and using mounting attachment points that use the existing tank doublers, the ABC provides a usable volume as shown in Figures 9.1.2-1 and 9.1.2-2. The ABC can accommodate both separating and non-separating payloads, with a volume that is slightly larger for non-separating payloads. The ABC is large enough to accommodate a 15-inch Motorized Lightband separation system.

Since the ABC is on the aft-end of the Centaur, it has the advantage of not interfering with the primary payload environment. It also has the ability to be deployed into low-Earth orbit during the Centaur first coast portion of the mission. The separation plane of the ABC is tilted 17 degrees relative to the longitudinal axis of the Centaur, providing clearance and no re-contact with the Centaur in coast. To avoid contamination or plume impingement, the Centaur inhibits the normal settling thrusters during the period of deployment.

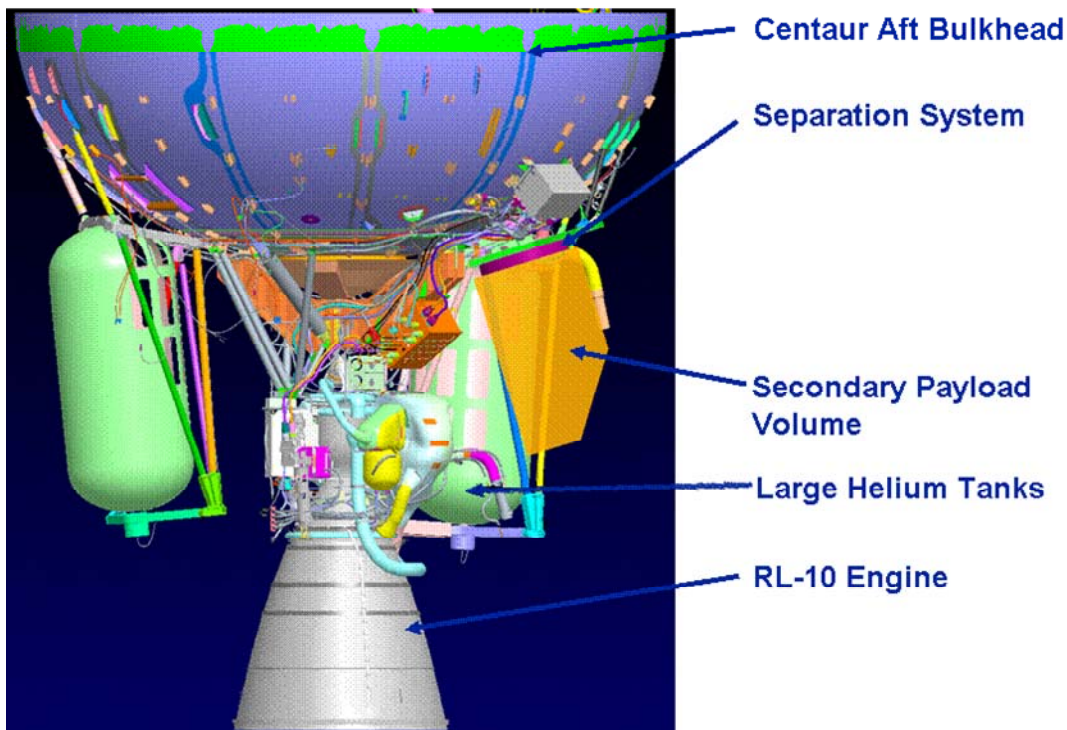
Figure 9.1.2-1: NPSCuL With Eight PPODs



NPSCuL-Lite P-POD Designation

AVUG11\_F090102\_01a

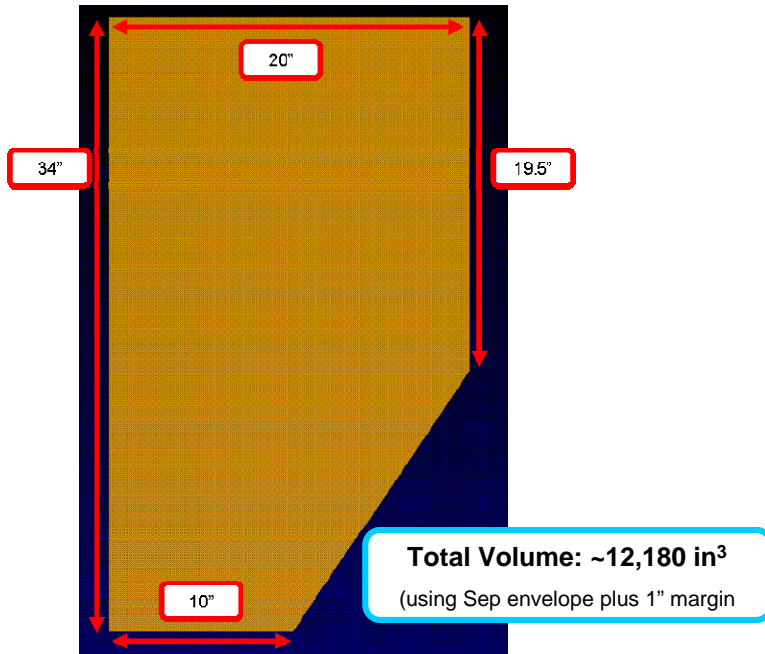
Figure 9.1.3-1: ABC Mounting Location



AVUG11\_F090103\_01a



Figure 9.1.3-2: ABC Usable Volume (Separating Payload)

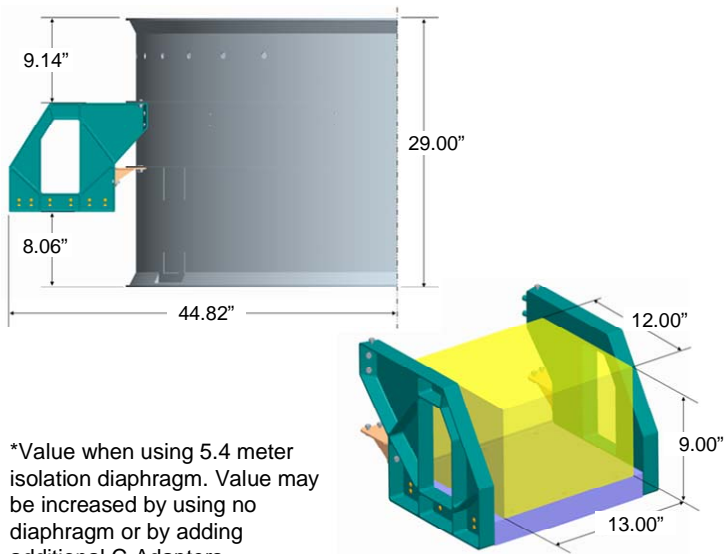


AVUG11\_F090103\_02a

**9.1.4 C-Adapter Platform**

The C-Adapter Platform (CAP) is located within the payload fairing and attached to the side of a C-adapter. It can carry an auxiliary payload with a mass up to 45 kg (100 lb). With additional qualification, it may be possible to increase this mass limit. Figure 9.1.4-1 shows the usable volume dimension of the CAP and its location on the side of a typical C-Adapter. Figure 9.1.4-2 shows how the C-29 Adapter can accommodate up to four CAP on a single flight. The number of CAPs and the positioning of the CAPs around the circumference of the C-adapter are subject to available mission margins and mission requirements. The CAP can accommodate various deployment options. It is large enough to accommodate an 8-inch Motorized Lightband, which can be mounted on either the base of the CAP or on the back wall.

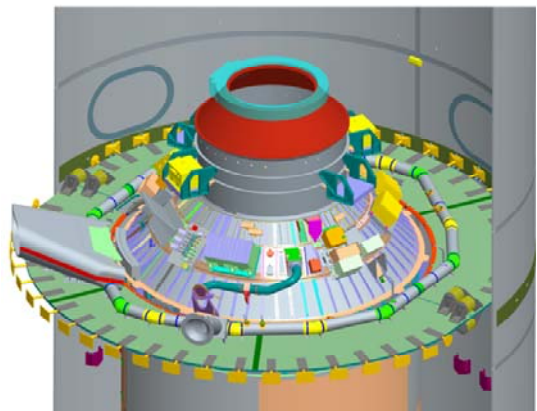
Figure 9.1.4-1: CAP Location and Volume



\*Value when using 5.4 meter isolation diaphragm. Value may be increased by using no diaphragm or by adding additional C-Adapters.

AVUG11\_F090104\_01a

Figure 9.1.4-2: Four CAPs Attached to C-Adapter

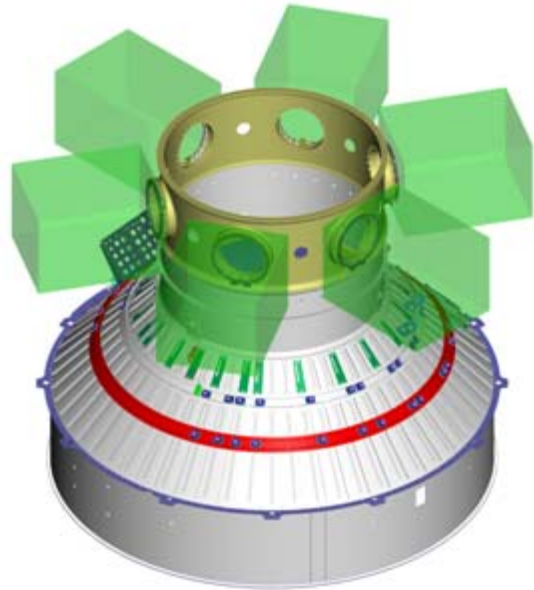


AVUG11\_F090104\_02a

**9.1.5 EELV Secondary Payload Adapter**

For missions with excess volume and where excess mass margin is available, auxiliary payloads can be launched using the EELV Secondary Payload Adapter (ESPA), a 1.5-m-dia (62-in diameter), 61-cm-tall (24-in-tall) ring structure that can support up to six Auxiliary Payloads (AP) around its circumference. The ESPA is mounted between the top of an Atlas Type C-adapter and the bottom of the primary SC payload adapter (Figure 9.1.5-1), duplicating the EELV standard interface plane (SIP), and passing the electrical interfaces through to the primary payload.

**Figure 9.1.5-1: Typical Atlas ESPA and C Adapter Structural Stack**



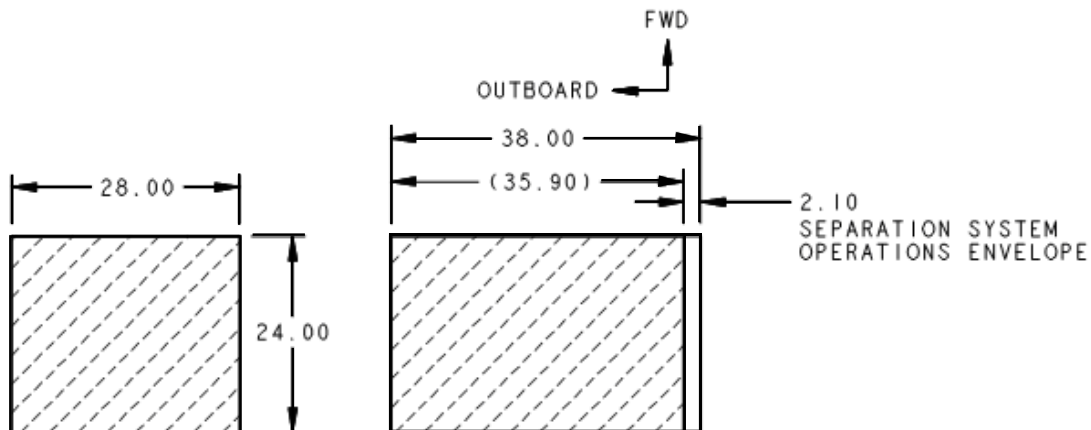
AVUG11\_F090105\_01a

The ESPA ring contains six 381-mm-dia (15-in diameter) bolt circle interfaces, with each being able to accommodate a single auxiliary payload of up to 181 kg (400 lb) in mass, and a volume of 61.0 cm x 71.1 cm x 96.5 cm (24 in. x 28 in. x 38 in.). This total volume includes a 5.33 cm (2.1 inch) separation system operational envelope as shown in Figure 9.1.5-2. Only the separation system, its mounting hardware and its harness are permitted inside the separation system operational envelope.

The auxiliary payload bolted interface hole pattern shall match the standard interface. The auxiliary payload may be attached to the ESPA with a ULA-supplied separation system or directly through an auxiliary payload provided adapter. The bolt circle has a diameter of 38.10 cm (15.000 inches).

Please see the ESPA Rideshare User's Guide or contact ULA for further information on the ESPA.

**Figure 9.1.5-2: APL Envelope Definition**



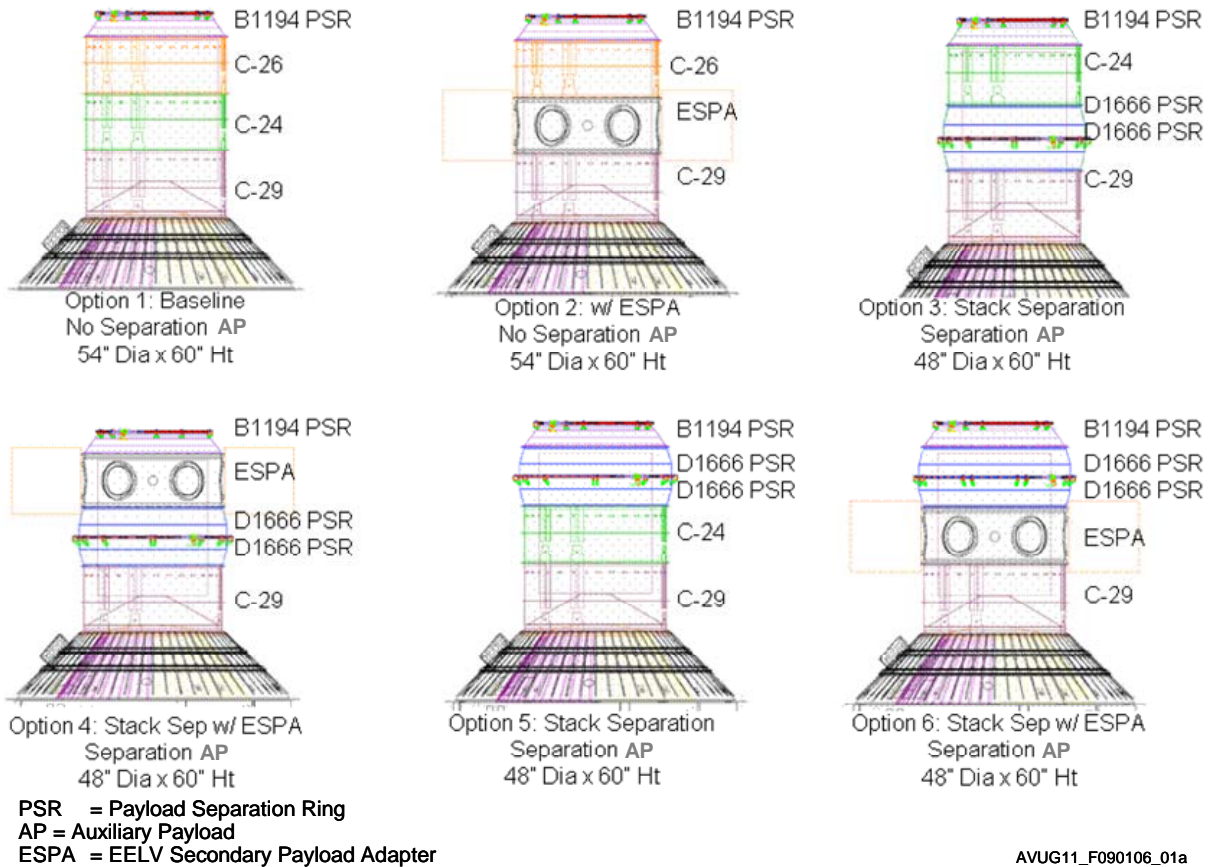
ALL DIMENSIONS IN INCHES

AVUG11\_F090105\_02a

9.1.6 Integrated Payload Carrier

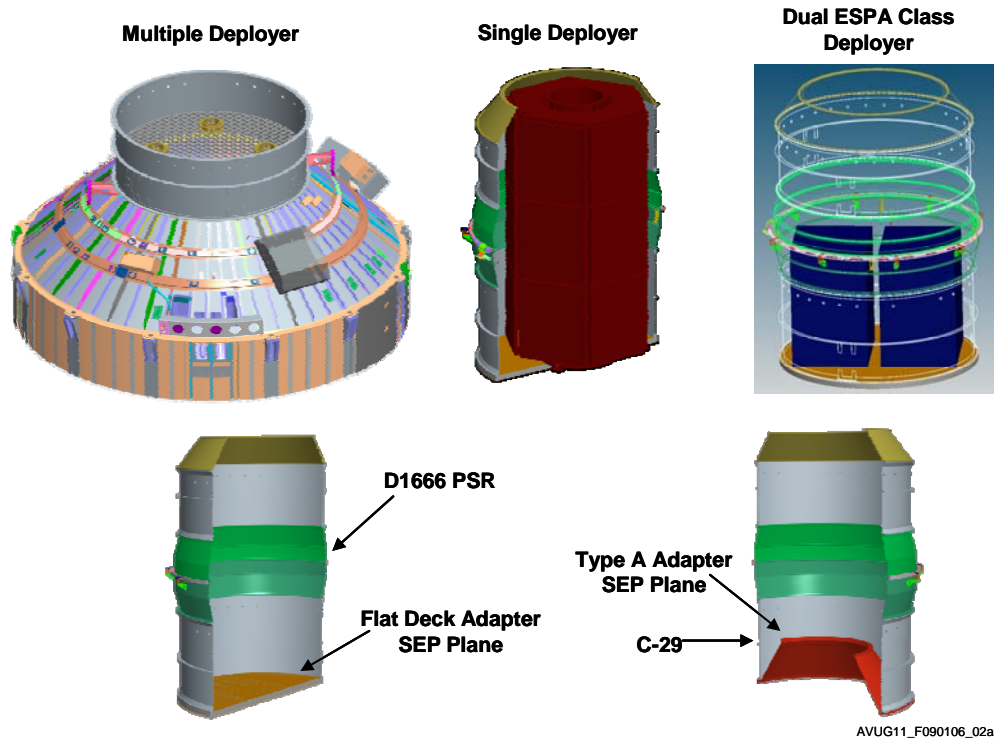
The Integrated Payload Carrier (IPC) is a flexible stack of ring segments that can accommodate various auxiliary payload types by providing a variety of configurations depending on the particular needs of the mission. It consists primarily of a mix of C-adapters of various heights (13, 15, 22, 25, or 29 inches) (Section 5.1.3). Additionally, a D-1666 separation system could be added in order to separate the upper portion of the IPC from the lower portion. Also, an ESPA ring could be added in place of a C-adapter in support of multi-manifest missions. Several examples of possible configurations appear in Figure 9.1.6-1.

Figure 9.1.6-1: IPC Stack Options



Using either an isogrid flat-deck or a conic section inside the IPC as the spacecraft interface, Atlas V can deploy one or multiple auxiliary payloads from within the internal volume (Figure 9.1.6-2). The internal diameter of a C-Adapter segment is 60 inches can accommodate auxiliary payloads diameters of up to approximately 50 inches. The height available to the auxiliary payload can vary by the types and number of adapters used.

Figure 9.1.6-2: IPC Internal Configurations



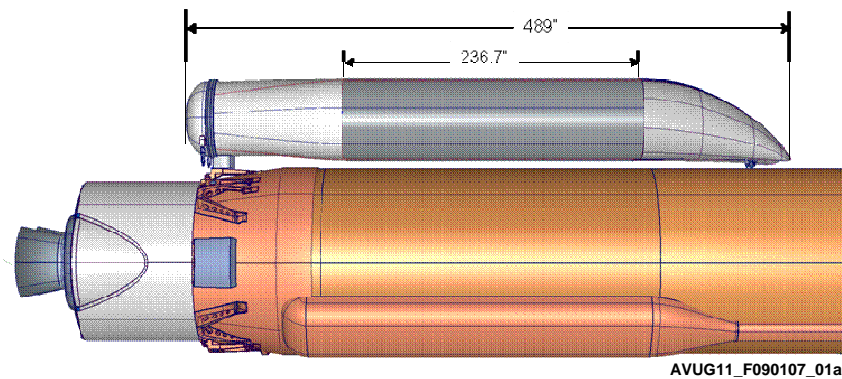
### 9.1.7 Suborbital Rideshare Carriers

ULA is developing a suborbital rideshare carriers. Figure 9.1.7 shows a study concept for an eXternal Payload Carrier (XPC) that provides large capability for suborbital missions. The XPC will ride with the booster up through booster separation from the upper stage, looking like an existing solid rocket motor. At booster separation, the XPC would be at a velocity of Mach 14 at an altitude of 700,000 ft.

The XPC will have a 5 ft diameter and 750 cubic feet volume. Technology development programs that would find the XPC beneficial may include Mars re-entry, Scramjet technology, or micro-gravity fluid dynamics and aerosols.

Currently the XPC is under a study contract, funded by NASA/KSC LSP and is being performed by an industry team led by Special Aerospace Services (SAS).

Figure 9.1.7: External Payload Carrier



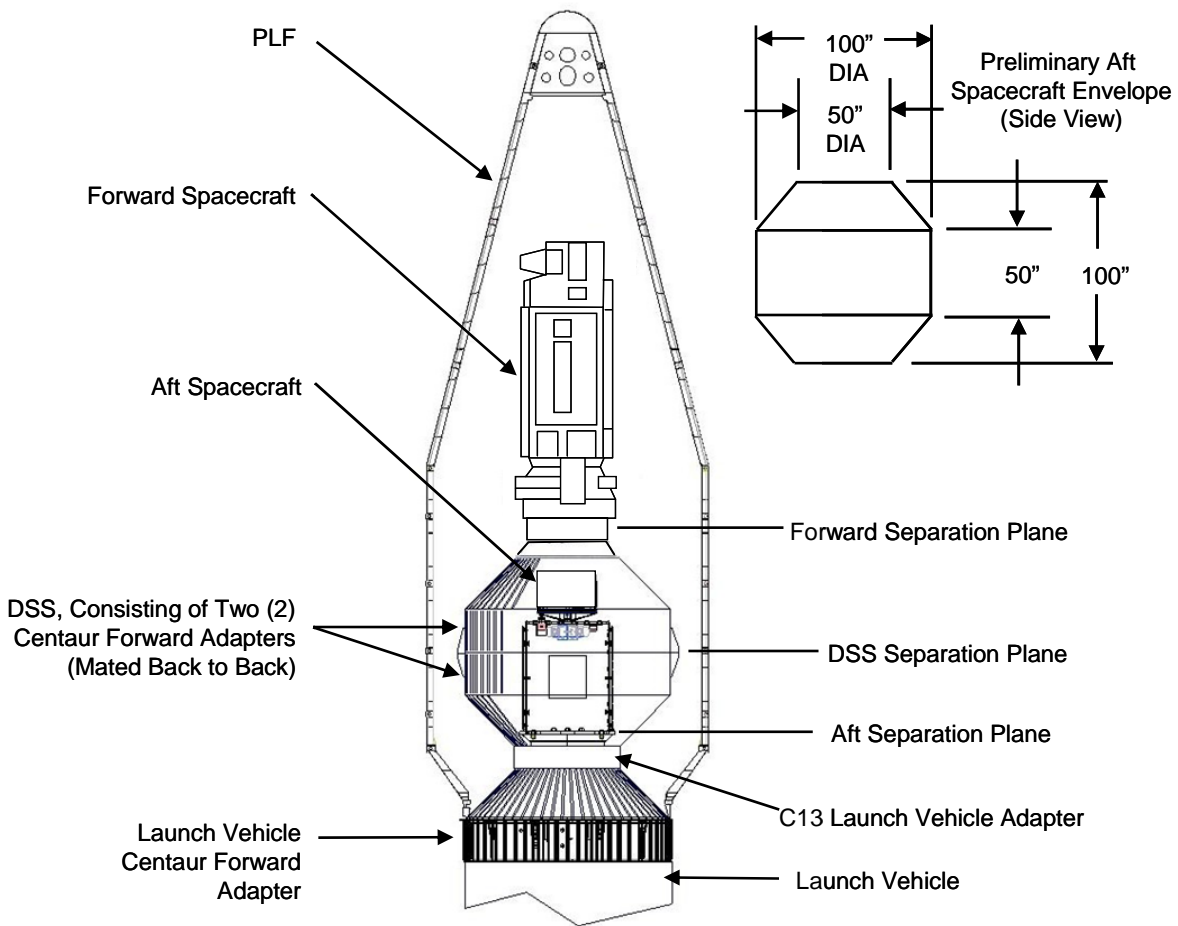
## 9.2 DUAL PAYLOAD ACCOMMODATIONS

The Atlas V program is developing dual manifest capabilities for both 4-m and 5-m missions, as described below.

### 9.2.1 Dual Spacecraft System

The Dual Spacecraft System (DSS) enables the launch of two independent, small-to-medium class spacecraft on a single Atlas V 4-m or Delta IV launch vehicle, as shown in Figure 9.2.1-1. The DSS makes extensive use of existing components with well-understood capabilities.

Figure 9.2.1-1: Dual Spacecraft System



AVUG11\_F090201\_01a

The DSS structure consists of two back-to-back Centaur Forward Adapters (CFAs) with an optional addition of one, two, three, or four DSS plug sections to provide flexibility in the heights of the forward and aft spacecraft volumes. The CFA is an assembly of one cylindrical stub adapter and a conical adapter attached by a common ring. In the DSS application, the cylindrical parts of a lower, inverted CFA and an upper, non-inverted CFA mate together. This creates a canister which contains the lower spacecraft. The Atlas V 4-m-diameter payload fairing completely encloses the upper spacecraft and the DSS, while the DSS itself encloses the lower spacecraft. The DSS supports the upper spacecraft and therefore all the loads from the upper spacecraft are carried by the DSS during vehicle flight. The forward interface of the DSS is the 62-inch Standard Interface Specification (SIS) payload interface, permitting use of existing payload adapters. The aft interface attaches to the Atlas launch vehicle using a standard C13 cylindrical payload adapter. Venting

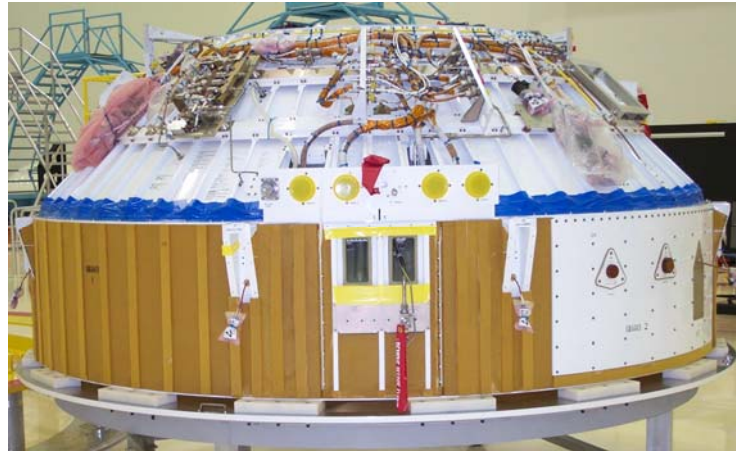


provisions are provided along with Environmental Control System (ECS) gas into the DSS interior as required. The DSS can be flown with an LPF, EPF, or XEPF as needed based on the lengths of the two spacecraft and the DSS.

The cylindrical and conical sections of the CFA are skin and stringer assemblies, joined together by a shared ring. Figure 9.2.1-2 shows that the CFA consists of two subassemblies: the Equipment Module and the Forward Stub Adapter. Together, they have flown more than 160 times since 1962.

The DSS design successfully completed a System Requirements Review (SRR) in June 2008 and a Preliminary Design Review (PDR) in September 2008. The system-level requirements and the derived requirements have been defined, and verification of all requirements is planned. ULA performed coupled loads analyses using Craig-Bampton models of 'indicator payloads' (tuned spring/mass/damper assemblies intended to simulate actual spacecraft) and using actual medium-class spacecraft. A Critical Design Review (CDR) for the DSS is scheduled in late 2009.

Figure 9.2.1-2: Centaur Forward Adapter Assembly



AVUG11\_F090201\_02a

The DSS hardware is already qualified and structural testing results are available, so the capabilities are well understood and known to be compatible with the Atlas and Delta launch vehicles. Development is simplified and nonrecurring costs and risks are reduced compared to those of a brand-new development.

Dual-spacecraft mission capabilities increase manifest flexibility and allow for additional spacecraft deployments for the same number of actual launches. The DSS is well-suited to launching small-to-medium class spacecraft, which are generally too big to be considered auxiliary payloads, but smaller than the typical Atlas 400 class payload. These spacecraft classes could find the DSS ride-share opportunities to be cost effective.

The DSS requires three separation systems: one for the upper spacecraft, one for the lower spacecraft, and one to separate the two CFA assemblies that make up the DSS itself. The first two separation systems depend on a given mission's requirements. The DSS CFA assemblies' separation system uses explosive bolts identical to those currently used to separate the Atlas V 4-m-diameter payload fairing. These bolts have also flown on heritage launch vehicles such as Titan/Centaur and Atlas I, II, and III. The fittings that house these separation bolts are derived from those used on the Atlas V 4-m fairing. These separation bolts and similar fittings have been used successfully approximately 2,700 times since the Atlas G first flew in 1984.

Analyses have rated the no-plug configuration to carry a spacecraft up to 10,000 lbs in the upper payload position and a spacecraft up to 8,000 lbs in the lower position. Versions with more plugs may have reduced capability in the upper position, depending on the number of plugs and spacecraft center of gravity distance from the interface plane. These weights should be considered preliminary estimates, not necessarily maximums or limits. A specific mission's coupled loads analyses will determine spacecraft responses and system clearance losses and will verify that the DSS loads are within its capability. Since the DSS is made up of CFA components, and loads from both spacecraft and the DSS are reacted by the CFA, it is likely the CFA will be loads-critical rather than the DSS itself. Coupled loads analysis so far verified that DSS/SC assemblies that remain within the mass and center of gravity limits corresponding to the Standard Interface Plane structural capability as shown in Figure 9.2.1-1. The minimum frequency guidelines given in Section 3.2.1 will give acceptable system loads.

Atlas has developed the preliminary payload envelopes that appear in Figures 9.2.1-3 through 9.2.1-7.

Figure 9.2.1-3: Preliminary DSS Payload Envelope — 4-m XEPF with No DSS Plugs

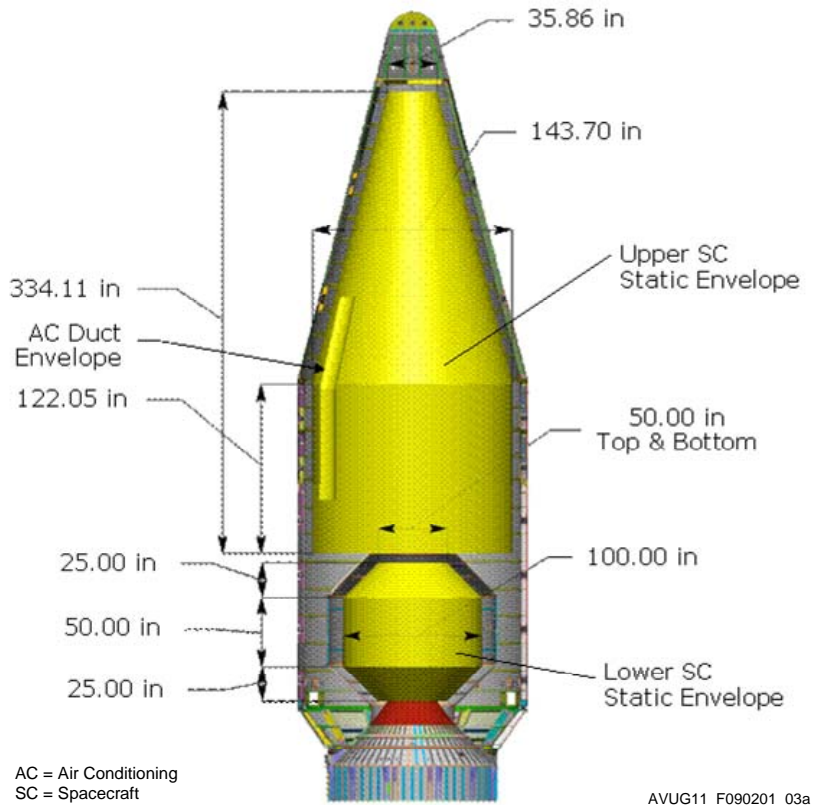


Figure 9.2.1-4: Preliminary DSS Payload Envelope — 4-m XEPF with One DSS Plug

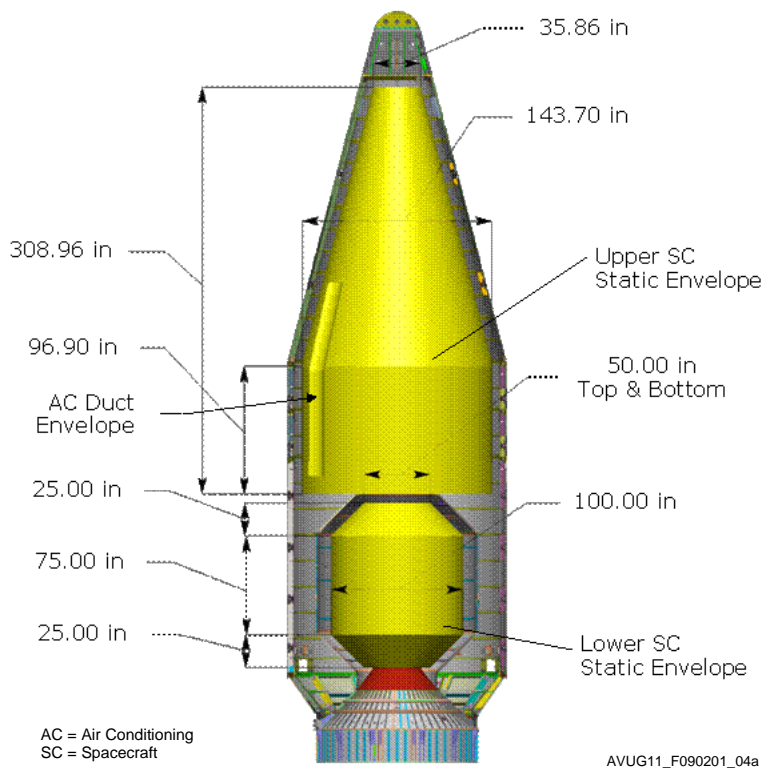


Figure 9.2.1-5: Preliminary DSS Payload Envelope — 4-m XEPF with Two DSS Plugs

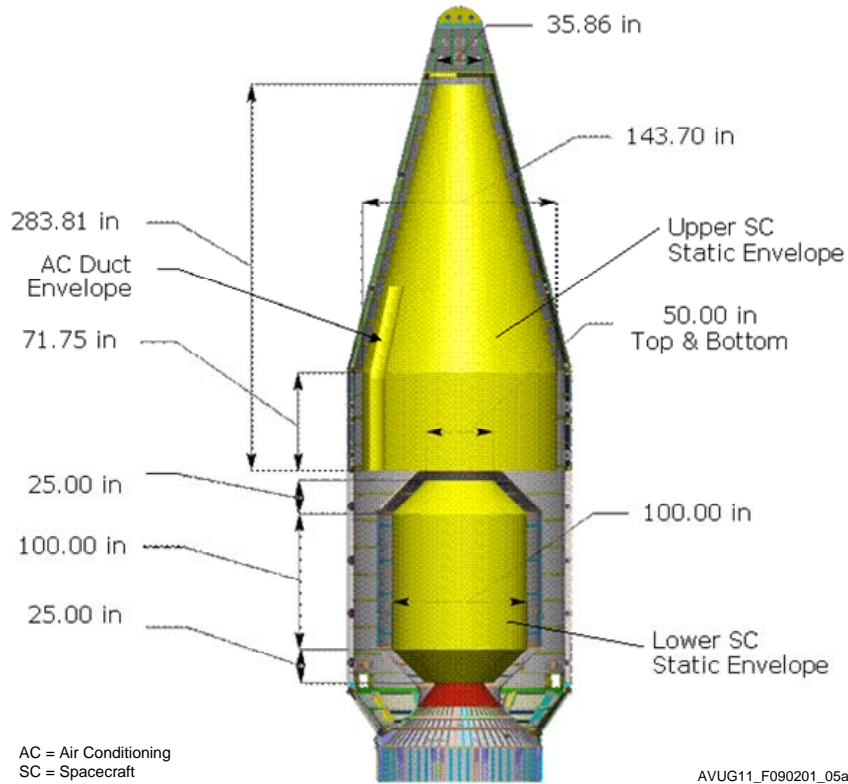


Figure 9.2.1-6: Preliminary DSS Payload Envelope — 4-m XEPF with Three DSS Plugs

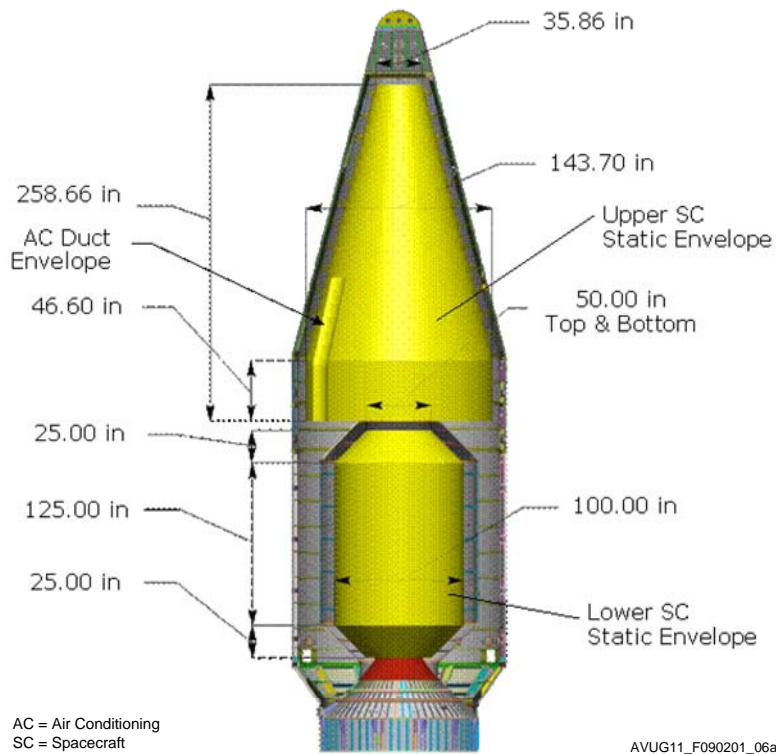
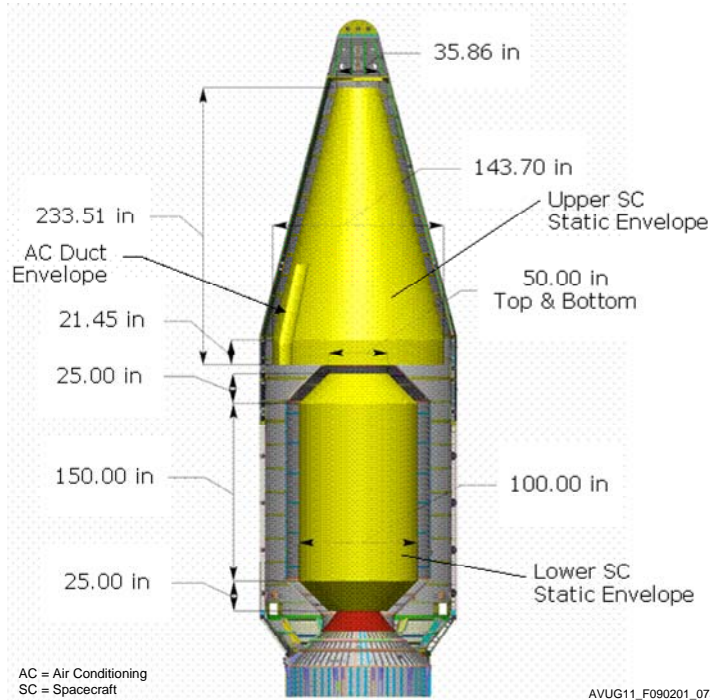


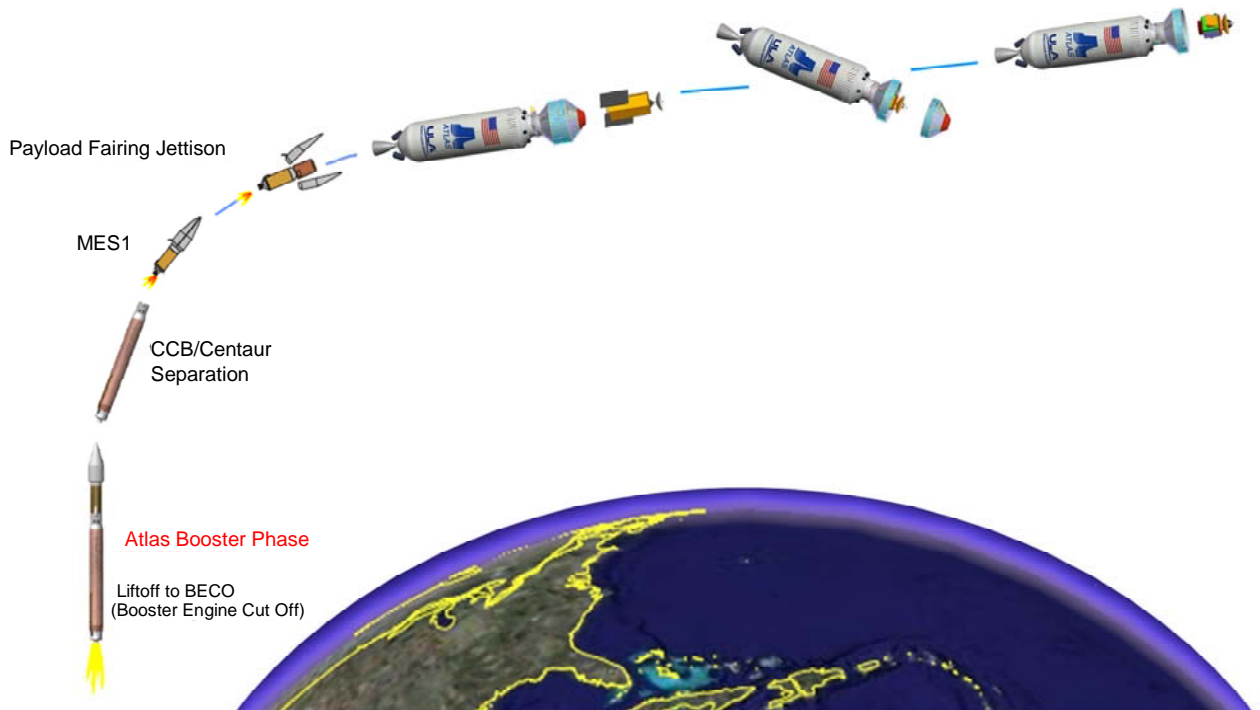


Figure 9.2.1-7: Preliminary DSS Payload Envelope — 4-m XEPF with Four DSS Plugs



ULA bases the concept of operations (ConOps) for payload processing on existing methods taking into account the added complexities of integrating a dual manifest. Wherever possible, existing ground processing activities and hardware have been used. Figure 9.2.1-8 shows the launch ascent ConOps.

Figure 9.2.1-8: DSS Concept of Operations



### 9.2.2 Dual Payload Carrier

ULA has completed the DPC PDR for use on the Atlas V with the 5m Medium PLF. The DPC gives the Atlas V the capability to simultaneously carry two medium- or intermediate-class spacecraft. The DPC is adjustable in height to accommodate payloads of different heights. The DPC is also available for the Delta LV.

The DPC fits entirely within the 5m medium PLF and divides the PLF volume into two payload compartments (Figure 9.2.2-1). The forward compartment payload static envelope has a diameter of 4,572 mm (180.0 in) at the base, and conforms to the shape of the PLF as it extends forward. The forward spacecraft mates to an Atlas V or customer-provided adapter that, in turn, mates to the 1,575-mm (62.01-in) diameter forward interface ring of the DPC.

The DPC encapsulates the aft spacecraft, which mates to an Atlas V or customer-provided payload adapter which, in turn, mates to the 1,575-mm (62.01-in.) diameter forward interface ring of a C-type adapter. This C-type adapter mates to the top of the Centaur forward adapter.

This aft compartment has a static payload envelope with a minimum 4,000-mm (157.5-in.) diameter. Figure 9.2.2-2 shows preliminary forward and aft payload static envelopes.

The DPC provides access to the aft spacecraft through standard 600-mm (23.6-in.) diameter doors, and it can provide accommodations for a reradiating system when required. Ports in the DPC structure will ensure adequate conditioned air passes through the aft compartment to maintain the required thermal environment for the aft spacecraft. The dispenser forward load reactor, near the top of the DPC cylinder section, controls relative motion between the DPC and PLF before PLF jettison.

The DPC structure, a lightweight, carbon fiber-reinforced composite sandwich structure, attaches to the forward interface of the 4,394-mm (173-in.) truss adapter.

To facilitate DPC jettison after forward spacecraft deployment, the DPC cylinder section contains a separation ring near its aft end. This pyrotechnic, frangible joint-type separation system contains all combustion byproducts and debris. After separation system actuation, a set of force-balanced springs pushes the DPC forward portion away from the aft spacecraft, ensuring adequate clearance is maintained between the DPC and aft spacecraft. The Centaur then turns to the required separation attitude and commands aft spacecraft separation.

Figure 9.2.2-1: Atlas V 500 Series Dual Payload Carrier

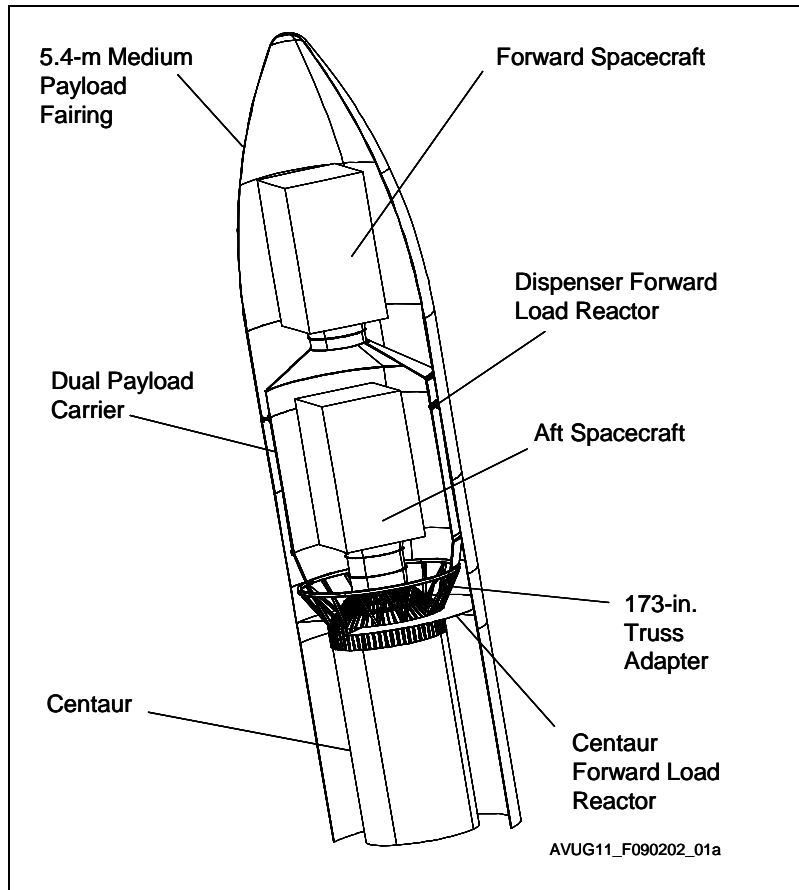
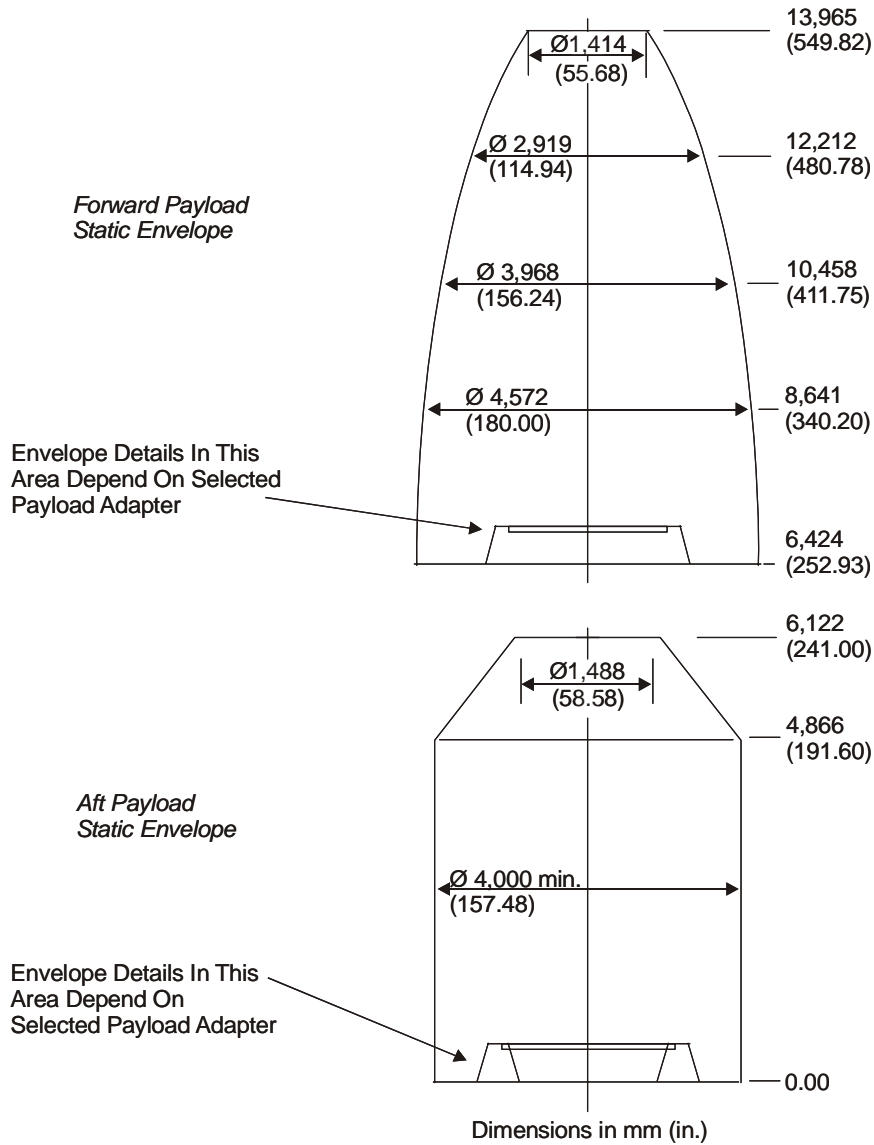


Figure 9.2.2-2: Dual Payload Carrier — Preliminary Payload Envelopes

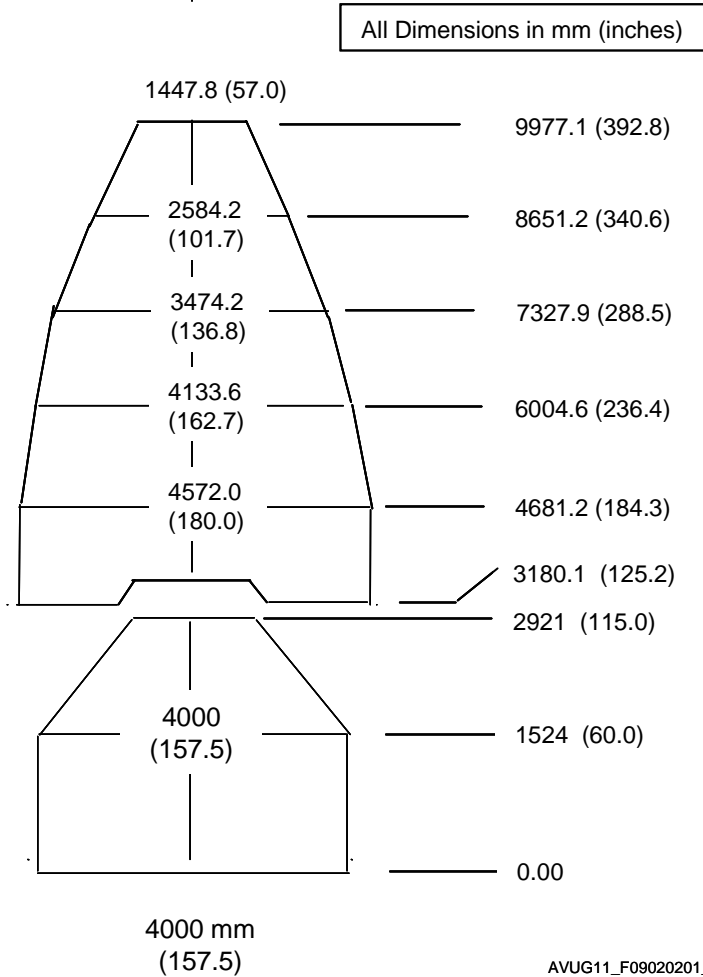


AVUG11\_F090202\_02a

9.2.2.1 Dual Payload Carrier — Short

ULA has completed an initial study for a DPC-Short (DPC-S) for use on Atlas V with the 5-m short PLF. It is derived from the DPC but is approximately 11.5 feet shorter, allowing it to fit in a Short 5-m PLF without a load reacting device (like the DFLR for DPC). This allows the 5-m short PLF to carry one intermediate class spacecraft and one small spacecraft. Figure 9.2.2.1-1 shows the preliminary static payload envelopes.

Figure 9.2.2.1-1: Dual Payload Carrier — Short — Preliminary Payload Envelopes



AVUG11\_F09020201\_01a

## APPENDIX A — ATLAS HISTORY, VEHICLE DESIGN, AND PRODUCTION

ULA manufactures and operates the Atlas V/Centaur launch vehicle (LV) to meet commercial and government medium, intermediate, and heavy space lift requirements.

### A.1 VEHICLE DEVELOPMENT

The Atlas program began in the mid-1940s with studies exploring the feasibility of long-range ballistic missiles. The Atlas LV family has evolved through various USAF, NASA, and commercial programs from the first Research and Development (R&D) launch in 1957 to the current Atlas V configurations (Figure A.1-1). More than 600 Atlas vehicles have flown since June 1957.

**Atlas Booster** — Versions of Atlas boosters were built specifically for manned and unmanned space missions, including the pioneering Project Mercury manned launches that paved the way toward the Apollo lunar program. The addition of the high-energy Centaur upper stage in the early 1960s made lunar and planetary missions possible. In 1981, the Atlas G booster improved Atlas/Centaur performance by increasing propellant capacity and upgrading engine thrust. This baseline was developed into the successful Atlas I, II, Atlas IIA, IIAS, IIIA and IIIB LVs.

Atlas V continues the evolution of the Atlas LV family. Today, as one of the world's most successful LVs, the Atlas V is offered in a comprehensive family of configurations that efficiently meet spacecraft (SC) mission requirements (Figure A.1-2).

The Atlas V system is capable of delivering a diverse array of SC, including projected government missions to Low Earth Orbit (LEO), heavy lift Geosynchronous Orbits (GSO), and numerous Geostationary Transfer Orbits (GTOs). To perform this variety of missions, ULA combines an Atlas booster powered by a single RD-180 engine with a standard Atlas V 4-m Large Payload Fairing (LPF), Extended Payload Fairing (EPF) or Extra Extended Payload Fairing (XEPPF) to create the Atlas V 400 series. For larger and heavier SC, the Atlas V 500 series combines the Atlas booster with a 5-m diameter Payload Fairing (PLF) available in three lengths of short, medium, and long. The Atlas V Heavy Lift Vehicle (HLV) design meets heavy SC mission requirements, combining three Atlas boosters with the 5-m Long PLF. The Atlas V 400 and 500 series include a common Centaur that can be configured with either a single or dual engine, depending on mission requirements.

The Atlas V system provides increased reliability over its predecessors. Atlas V achieves the increased reliability through a simplified design that incorporates fault avoidance, fault tolerance, and reduction of Single Point Failures (SPF). Production Engineering and Test Engineering have been involved in all phases of the design process leading to producibility and testability improvements that have yielded streamlined and repeatable manufacturing processes. The ultimate result is a reduction in nonconformances and defects, which translates into more reliable processes and hardware.

The robustness of the Atlas V system is enhanced with common system elements assembled into a family of vehicles that satisfy a wide range of mission requirements while providing substantial performance margins. In addition to common elements, the Atlas V system features improved structural capability allowing it to withstand worst-case, day-of-launch winds. The result is increased launch availability.

At the launch site, standard LV elements, facilities, and equipment allow standardized launch site procedures and common processes. Vehicle processing time is greatly reduced because of increased emphasis on factory testing and delivery of flight worthy elements to the launch site. Limiting launch site testing to system level tests virtually eliminates the need for intrusions into subsystems. This also reduces the probability of inadvertent damage and increases launch availability. Performing simultaneous processing of the booster, the Centaur, and the encapsulation of a preprocessed SC in separate facilities reduces critical path activities on the launch pad.

Figure A.1-1: Atlas Launch Vehicle Successful Evolution

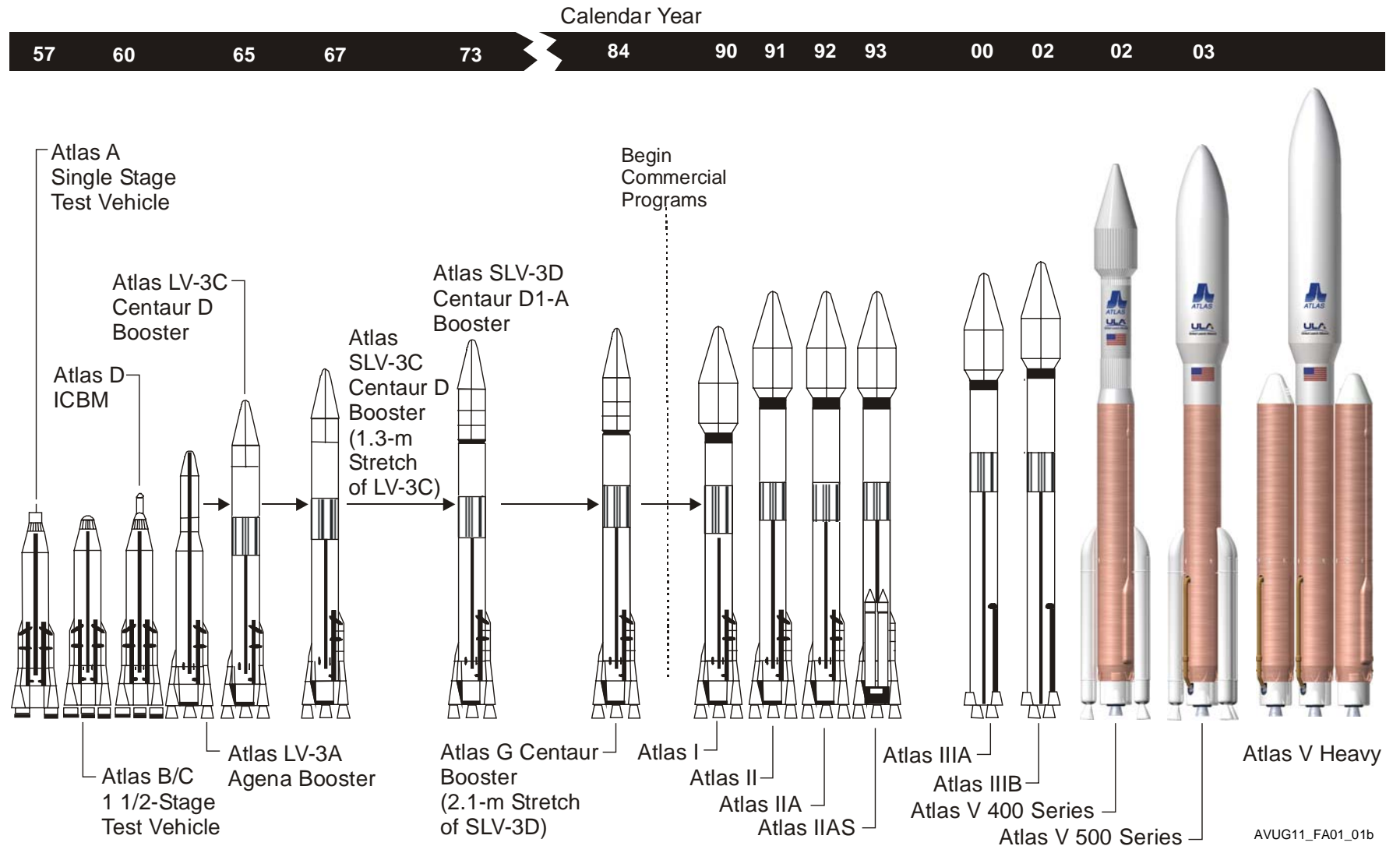
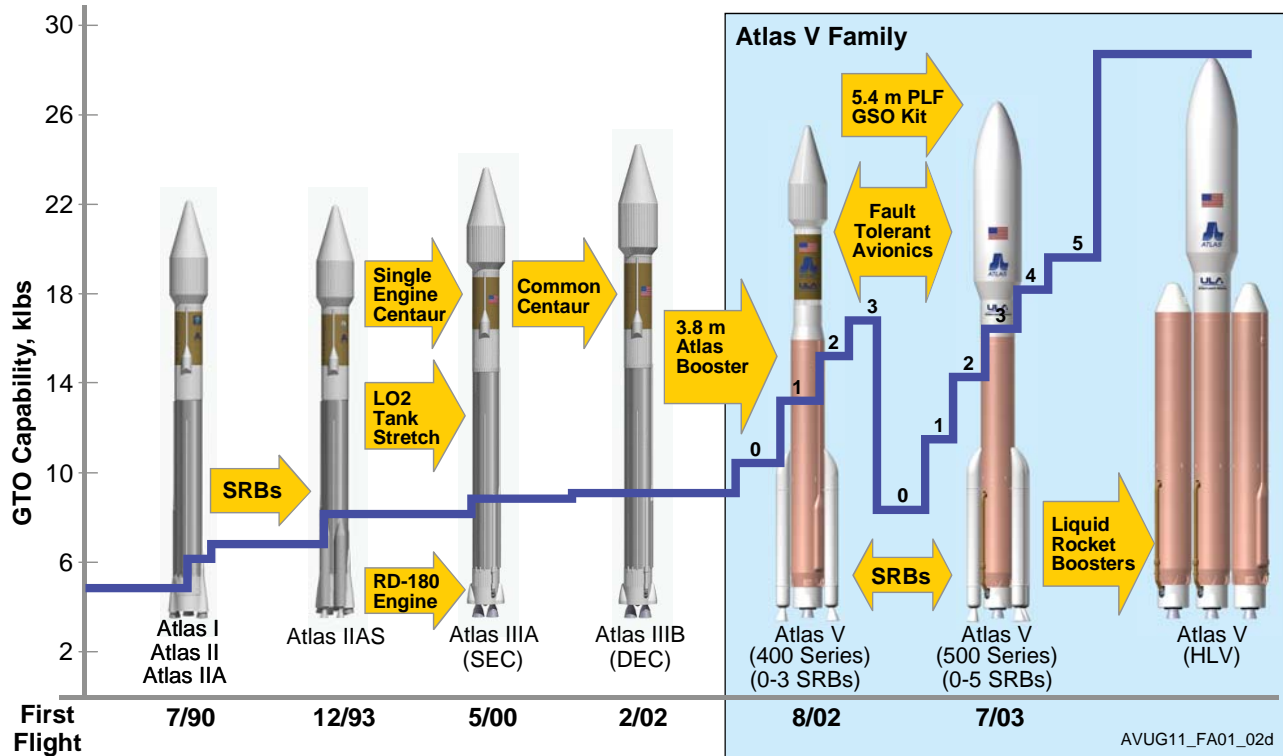


Figure A.1-2: Atlas V Configurations and Performance Evolution



Finally, the robustness and flexibility of the Atlas V enables the use of a Class Analysis approach to mission integration. Class Analyses take place during the non-recurring phase of the program to encompass the known variations in individual vehicles and missions. As a result, mission integration times and costs are reduced. Also, mission success is maintained by eliminating recurring characterization of LVs and minimizing recurring analyses.

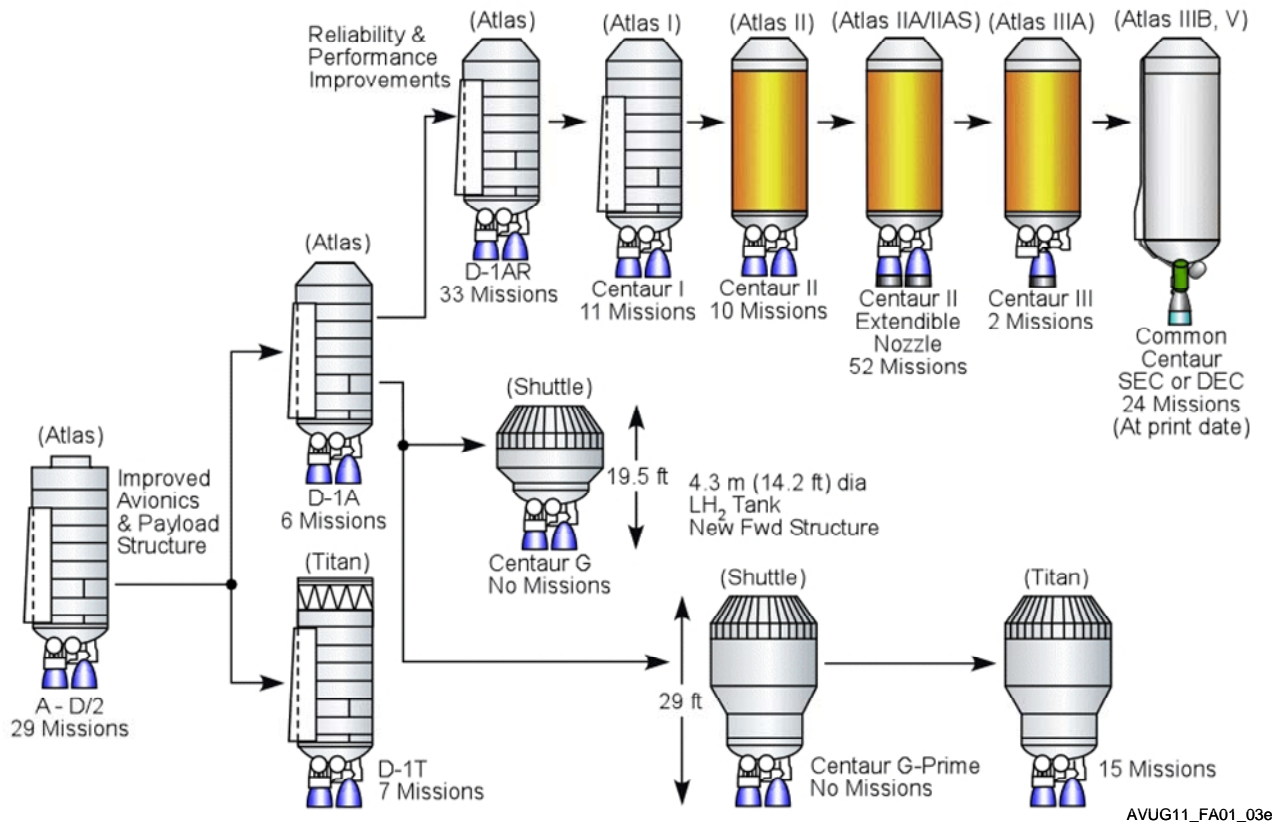
**Common Centaur** — Development began on the Centaur high-energy (high-specific impulse) upper stage in 1958 to launch NASA SC on lunar and planetary missions. NASA’s ambitious planetary exploration goals required development of improved avionics; capable of guiding the Surveyor soft-lander space probes on lunar missions. Throughout the operational history of Centaur, systematic upgrades to the avionics have provided outstanding orbital insertion accuracy with favorable cost and weight. Centaur’s evolution to the Atlas V Common Single Engine Centaur (SEC) and Dual Engine Centaur (DEC) configurations is shown in Figure A.1-3.

The first successful flight of the Centaur on an Atlas LV in November 1963 was the world’s first in-flight ignition of a hydrogen-powered vehicle. Three years later, Centaur performed the first successful space restart of liquid hydrogen (LH<sub>2</sub>) engines in October 1966. With this flight, the R&D phase was completed, and Centaur became fully operational. Multiple engine starts after long coast periods in space enable Centaur to provide exceptionally accurate targeting. The Centaur has flown more than 187 missions on Atlas and Titan boosters, ranging from communications SC to earth orbit to the historic Mariner, Pioneer, Viking, and Voyager planetary exploration missions. In January 2006, Atlas V-010 launched the New Horizons mission on its 9-year flight to Pluto. Throughout this history, the design has been refined and enhanced, enabling Centaur to remain the most efficient and accurate upper stage in the world.

**Atlas Centaur Launch System** — More than 160 SC have been integrated and launched on the Atlas/Centaur space launch system during the past 47 years. The delivery of lunar and planetary missions to precise orbits and the accommodation of diverse Earth-orbiting SC platforms are noteworthy. Table A.1-1, at

the end of this appendix, chronologically lists each Atlas/Centaur flight with details of mission type and status.

**Figure A.1-3: Centaur Evolution Accommodates Boost Vehicle Performance and Reliability**



## A.2 VEHICLE DESIGN

ULA manufactures the Atlas V booster and Centaur using common, qualified components and production procedures. The following sections describe the features of the Atlas family of launch systems with an emphasis on evolutionary improvements to the Atlas V. Atlas booster system characteristics are described first, followed by the Centaur system characteristics.

### A.2.1 Atlas V Launch Vehicle Major Characteristics

**Overview** — The Atlas V LV system is based on the flight-proven, structurally stable 3.8-m (12.5-ft) diameter Atlas booster powered by a single RD-180 engine. To meet the evolving requirements of SC users, the Atlas V 400 and 500 series can tailor performance by incorporating Solid Rocket Boosters (SRBs). The mission design capabilities for Atlas V are significantly enhanced relative to previous Atlas and Titan LVs. The capabilities available for heritage vehicles have been maintained and enhanced in the Atlas V design. One example is optimized in-flight retargeting based on actual booster performance. Another example is use of multiple Centaur main engine burns with extended coast times for GSO three-burn missions.

**Commonality** — The cornerstone of the Atlas V system design is the use of common system elements. The same or very similar hardware elements are used across the Atlas V 400 and 500 series LVs, and Atlas HLV. The Atlas booster in the Atlas V 400 and 500 series is identical, up to and including the SRB attachment fittings and harnessing to fly up to five SRBs. The booster and Centaur avionics components are also common. The three different lengths of 5-m PLF, discussed in Section 6.2, used for the Atlas V 500 series LVs are all common, with the exception of a kitable nine or nineteen foot payload fairing section to



provide the differing lengths. The same is true for the three available lengths of the 4-m PLF, discussed in Section 6.1, used for Atlas V 400 series LVs.

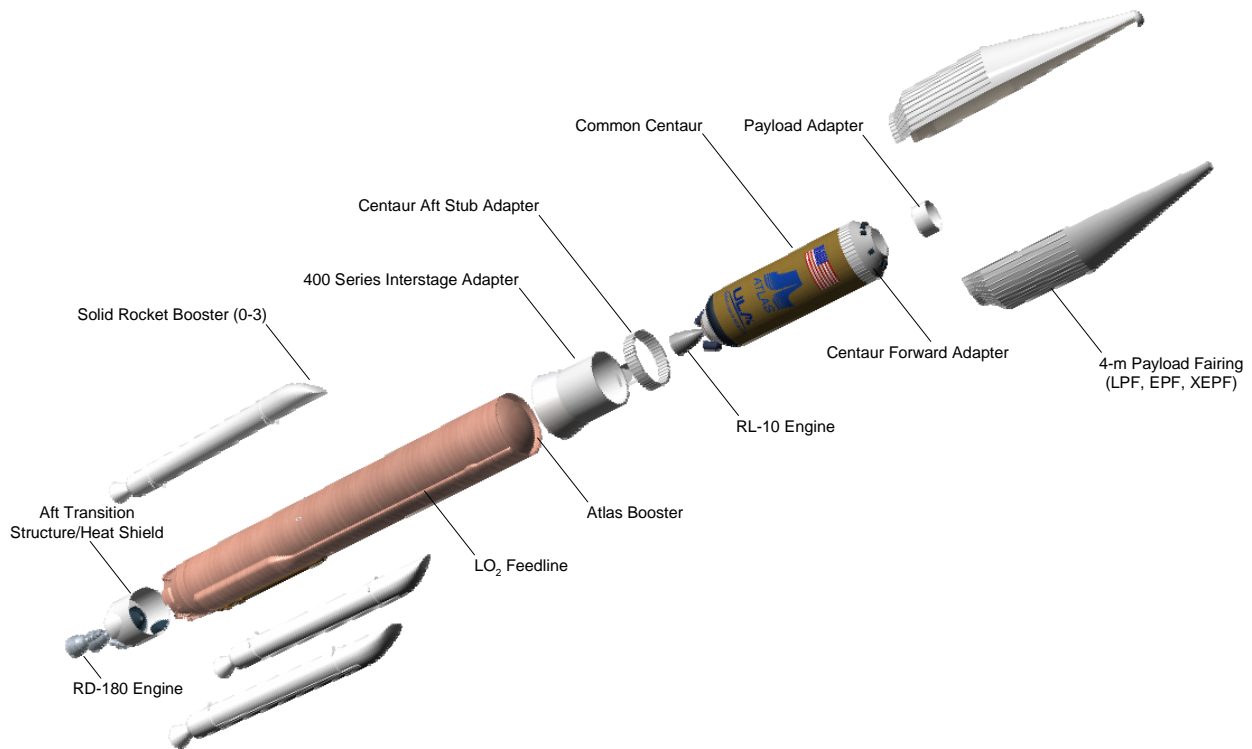
**Reliability** — There are two fundamental methods, fault avoidance and fault tolerance, in which reliability is infused into the Atlas V system design. The essence of fault avoidance is creating a simpler design where fewer opportunities for failure exist or through greater margin; moving away from the edge of the system's capability. An example of fault avoidance is reduction in the number of LV booster engines. Fault tolerance, on the other hand, is accomplished through redundancy or by implementing processes like prelaunch checkout of the RD-180 engine. This capability allows verification that the booster engine has properly started and is up to 60% power before the commitment to launch. If a problem is detected, the engine can be safely shut down and the problem can be corrected.

Extreme care is taken to reduce the probability of failure through qualification, acceptance testing, and process controls for systems such as engines that are susceptible to SPFs and where redundancy is cost prohibitive. The booster and Centaur liquid engines are qualified with substantial margin. Margins in thrust level, run duration, and inlet conditions are demonstrated and each flight engine is acceptance tested to full flight duration.

One measure of the success of the Atlas V reliability design process is the reduced number of SPF susceptibilities inherent in the system. Once structural SPFs are subtracted, the number of active SPFs was reduced approximately 70% when compared to the Atlas IIAS vehicle.

The Atlas V family of LVs can be launched from Cape Canaveral Air Force Station (CCAFS) Space Launch Complex 41 (SLC-41) or Vandenberg Air Force Base (VAFB) SLC-3E to support various SC mission requirements. Figure A.2.1-1 shows the Atlas V 400 series in expanded view. Figure A.2.1-2 shows the Atlas V 500 series in expanded view. Figure A.2.1-3 shows the Atlas V HLV in expanded view. The following paragraphs describe the components that comprise the Atlas V system.

**Figure A.2.1-1: Atlas V 400 Series Launch Vehicle**



AVUG11 FA0201 01e

Figure A.2.1-2: Atlas V 500 Series Launch Vehicle

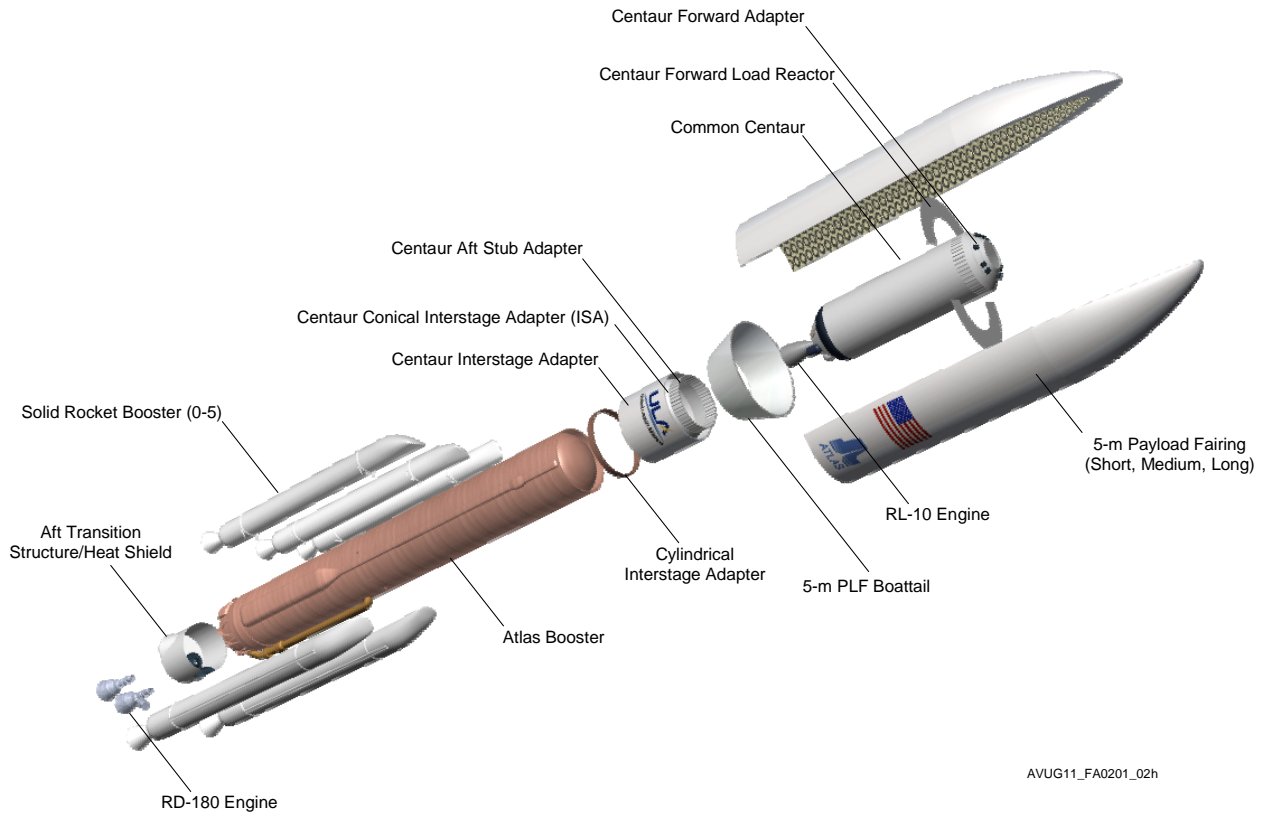
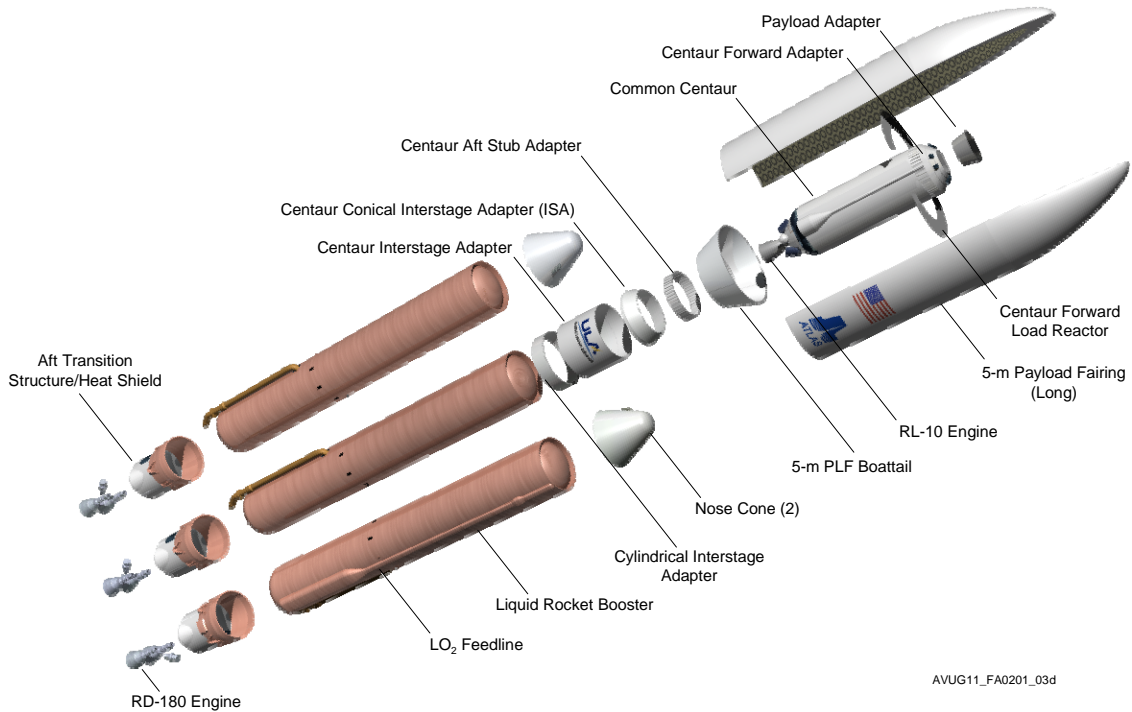


Figure A.2.1-3: Atlas V HLV Launch Vehicle



## A.2.2 Atlas Booster

The Atlas booster provides the main propulsive stage for the Atlas V launch vehicle family. It is powered by a single RD-180 engine fueled by Liquid Oxygen (LO<sub>2</sub>) and a highly purified form of kerosene called RP-1 (Rocket Propellant-1). The standard Atlas booster configuration is fully common and interchangeable between the Atlas V 400 and 500 series vehicles. It can accommodate up to three strap-on SRBs for the Atlas V 400 series and up to five strap-on SRBs for the Atlas V 500 series. The light Atlas Booster configuration (no SRB capability) is used on the Atlas V HLV. The Atlas V HLV uses a core Atlas booster and two outrigger Atlas boosters as liquid rocket boosters.

### A.2.2.1 Booster Structure

The Atlas booster, 3.8-m (12.5-ft) in diameter and 33-m (109-ft) long, is constructed of structurally stable aluminum isogrid tanks. The Atlas booster structure is comprised of only eight simple subassemblies, a more simplified design from the Atlas IIAS, which used over 100 parts and subassemblies. The booster's avionics components are located in a pod structure, which runs along the side of the fuel tank. An expanded view of the Atlas booster is shown in Figure A.2.2.1-1, and a description of Atlas booster components is included in the following paragraphs.

**Atlas Booster LO<sub>2</sub> Tank** — The structurally stable, welded aluminum Atlas Booster LO<sub>2</sub> tank is composed of forward and aft barrel section joined by a splice ring, a one-piece spun-formed forward dome with manhole cover, and a one-piece spun-formed aft dome with a sump. Each barrel section is made of four isogrid aluminum panels welded together. The splice ring is an aluminum machined rolled-ring forging. The LO<sub>2</sub> intertank skirt attaches to aft end of the tank and joins the LO<sub>2</sub> tank to the RP tank. The skirt is aluminum isogrid with aluminum ring frames. A forward adapter skirt joins the LO<sub>2</sub> tank to the Atlas booster interstage adapter (conical ISA for the Atlas V 400 series and cylindrical ISA for the Atlas V 500 series). The forward adapter skirt is aluminum 2014 isogrid panels with aluminum ring frames.

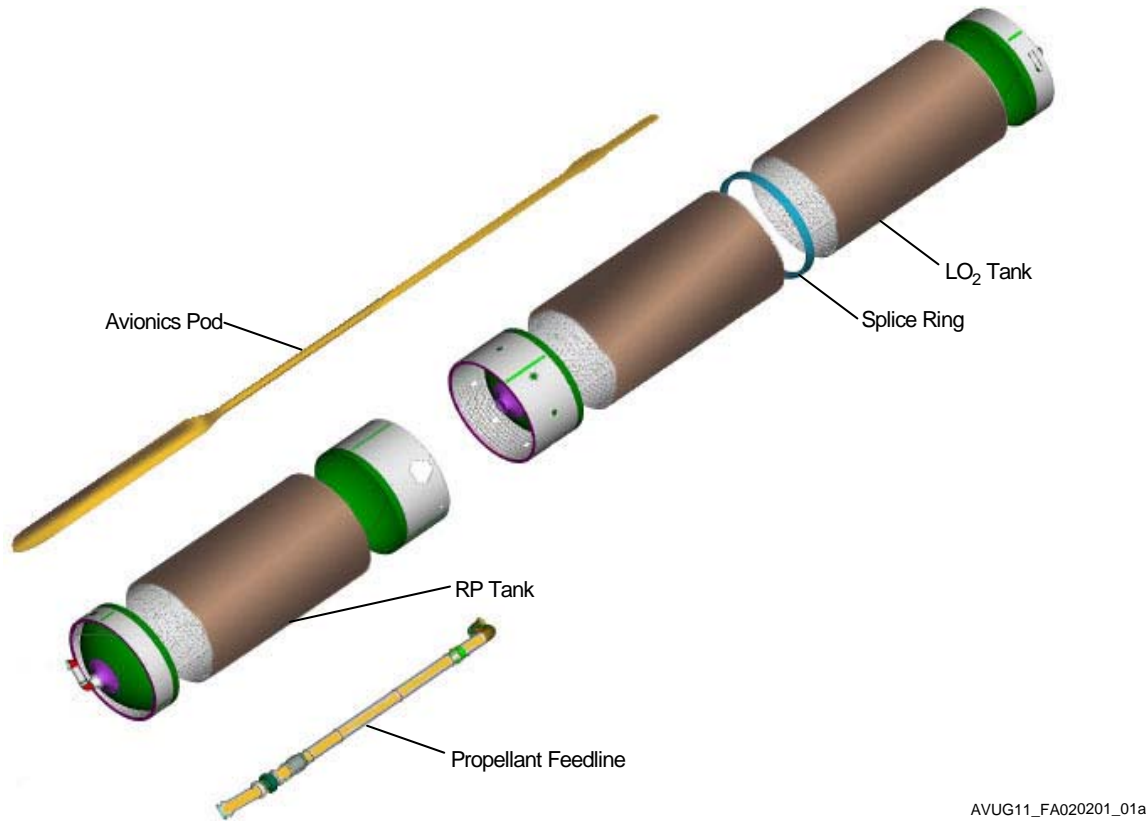
**Atlas Booster RP Tank** — The structurally stable, welded aluminum Atlas Booster RP tank is composed of a single barrel, a one-piece spun-formed forward dome with a manhole cover, and a one-piece spun-formed aft dome with a sump. The barrel section is made of four isogrid aluminum panels welded together. The RP intertank skirt attaches to the forward end of the tank and joins the RP tank to the LO<sub>2</sub> tank. The adapter is aluminum isogrid with aluminum ring frames. The RP adapter skirt joins the aft end of the tank to the Aft Transition Structure (ATS). The skirt is aluminum 2014 isogrid panels with aluminum ring frames.

**Propellant Feedlines** — The Atlas booster propellant feedlines are aluminum duct assemblies that deliver the LO<sub>2</sub> and RP propellants from the tanks to the RD-180 engine. The LO<sub>2</sub> feedline runs from the bottom of the LO<sub>2</sub> tank, along the outside of the RP tank to the ATS and the engine. The RP feedline runs from the bottom of the RP tank through the ATS to the engine.

**Pressurization System** — The Pressurization System for the Atlas booster provides for the in-flight pressurization of the fuel (RP-1) and oxidizer (LO<sub>2</sub>) propellant tanks. Additionally, the Pressurization System provides the airborne hardware necessary to allow pressurization from the ground during transportation, storage, prelaunch, and launch countdown operations. The Pressurization System is designed to meet the structural requirements of the propellant tanks, and to provide the required pump inlet pressures to the RD-180 boost pumps.

The major components of the Pressurization System for each Atlas booster consist of four Composite Overwrapped Pressure Vessels (COPVs) to store helium; a fuel and LO<sub>2</sub> pressurant Flow Control Assembly (FCA) to control the flow of helium from the COPVs to the respective propellant tanks; and filters prior to the flow control assemblies to isolate the fuel and LO<sub>2</sub> gas systems. Two sets of three pressure transducers measure tank pressures in the fuel and LO<sub>2</sub> propellant tanks, respectively. These transducers are monitored by the airborne computer system and used to command the FCA valves open and closed as required to meet a predetermined tank pressure profile during flight.

Figure A.2.2.1-1: Atlas Booster Components



AVUG11\_FA020201\_01a

**Avionics Pod** — The electronics that control Atlas booster flight are housed in the avionics pod. The main equipment pod is located along the outside of the RP tank and provides mounting and protection for the Booster Remote Control Unit (BRCU), batteries, Ordnance Remote Control Assembly (ORCA), instrumentation system, and flight termination system. The upper part of the avionics pod provides a raceway for the electrical harnessing and mounting and protection for a rate gyro unit.

#### A.2.2.2 Aft Transition Structure and Heat Shield

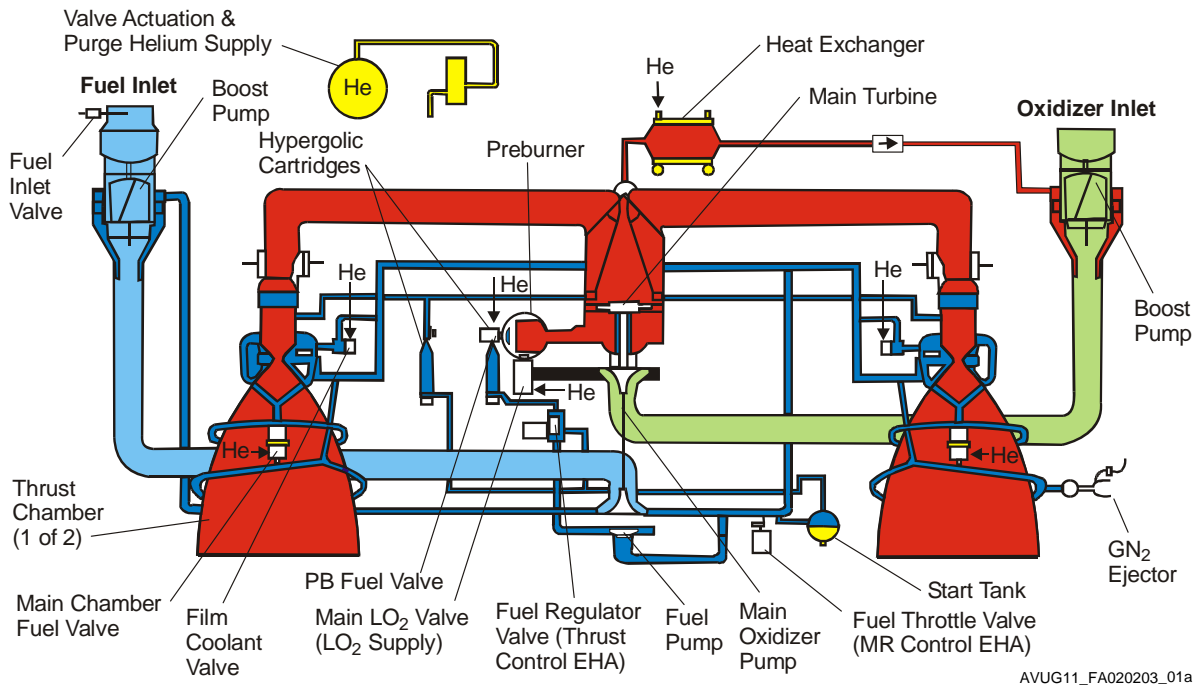
The RD-180 engine is attached to the Atlas booster through the ATS. The ATS provides the structural load path for the engine thrust loads and houses two of the helium bottles used to pressurize the propellant tanks. The heat shield provides thermal protection and environmental closure for the engine compartment. The ATS is constructed of aluminum 7075 ring frames and fittings with aluminum 2040 skins. The ATS is built from integrally machined aluminum components, harnesses, tubing, and helium bottles. The heat shield is a composite structure with graphite epoxy facesheets over an aluminum honeycomb, and aluminum ring frames.

#### A.2.2.3 RD-180 Engine

The RD-180 engine, provided by RD AMROSS, a joint venture of Pratt & Whitney and NPO Energomash, is a two-chamber design fed by a common turbopump assembly. The engine is a total propulsive unit with an integral start system and hydraulics for control-valve actuation and thrust-vector gimbaling, pneumatics for valve actuation, and a thrust frame to distribute loads; all self-contained as part of the engine. Nominal thrust at sea level is 3826 kN (860,200 lbf). The RD-180 operates on a staged combustion cycle using LO<sub>2</sub> oxidizer and RP-1 fuel and is capable of continuous throttle between 47% and 100% of nominal thrust, allowing for substantial control over LV and SC environments. Programmed thrust profiles can throttle the engine back to minimize vehicle loads during the peak transonic load and high dynamic pressure periods of flight while

otherwise maximizing performance at higher sustained acceleration. The two-chamber RD-180 (Figure A.2.2.3-1) is a derivative of the four-chamber RD-170/171 engines used on Russia's Energia boosters (more than 25 flights). Initial test firings of the RD-180 occurred in July 1997 and the engine was flight proven in May 2000, the inaugural mission of Atlas III. Atlas V uses the same RD-180 engine flown on Atlas III. The RD-180 is flight-proven for Atlas V 400 and 500 series LV configurations (25 flights at print date) with more than 41,400 seconds in 221 firings at time of this publication. The Atlas V propulsion system has fewer components and booster staging events than previous Atlas or Titan LVs. The Atlas V 401 LV uses only two propulsion subsystems and three staging events for a GTO mission, a significant reduction in comparison to the Atlas IIAS mission to GTO requiring nine propulsion subsystems and seven staging events.

Figure A.2.2.3-1: RD-180 Engine Schematic



### A.2.3 Solid Rocket Booster

The Solid Rocket Booster (SRB) is 1.5-m (5-ft) in diameter, 20.4-m (67-ft) long, and weighs approximately 46,000 kg (51 tons). Each SRB is identical, interchangeable, and is designed for reliability. The SRBs are all ground-lit, have a fixed nozzle that is canted at 3 degrees, and are monolithic in design (no segment joints). The SRBs use simplified, proven elements adapted from operational U.S. government systems, including a graphite-epoxy case, carbon phenolic nozzle, and high-performance Class 1.3 HTPB propellant. The SRBs are manufactured by Aerojet and shipped in a ready-to-fly configuration by truck to the launch site where they are installed on the LV with no launch site processing.

### A.2.4 Atlas V Interstage Adapters

#### A.2.4.1 400 Series Interstage Adapter

The 400 Series Interstage Adapter (400-ISA) provides the structural attachment from the Atlas booster to the Centaur Aft Stub Adapter (ASA, A.2.4.2). It provides the diameter change from 3.8-m (12.5-ft) diameter to the Centaur 3.05-m (10-ft) diameter in the 400 series configuration. The 400-ISA is an aluminum honeycomb/graphite epoxy composite structure with aluminum interface rings.

#### **A.2.4.2 Centaur Aft Stub Adapter**

The Centaur Aft Stub Adapter (ASA) is an aluminum structure that provides the structural attachment to the Centaur. The ASA contains the Frangible Joint separation system for use in separating the Atlas booster from the Centaur upper stage. The ASA flies on all Atlas V 400 and 500 series vehicles. For 400 series vehicles, the ASA mates to the 400 Series Interstage Adapter (400-ISA, A.2.4.1). For 500 series vehicles, the ASA mates to the Centaur Conical Interstage Adapter (A.2.4.3).

#### **A.2.4.3 Centaur Conical Interstage Adapter**

The Centaur conical interstage adapter provides the transition from the 3.05-m (10-ft) diameter Centaur aft stub adapter to the 3.8-m (12.5-ft) diameter Centaur interstage adapter. It is an aluminum skin stringer structure. The Centaur conical interstage adapter is bolted to the Centaur aft stub adapter, and this subassembly is then installed inside the Centaur interstage adapter. The Centaur conical interstage adapter is used on the Atlas V 500 series and HLV.

#### **A.2.4.4 Centaur Interstage Adapter**

The 3.8-m (12.5-ft) diameter Centaur Interstage Adapter (CISA) provides the attachment between the Atlas booster, the Centaur, and the 5-m PLF boattail. The C-ISA is a composite structure with graphic-epoxy facesheets over an aluminum honeycomb core. The 3.8-m (12.5-ft) diameter C-ISA is used on the Atlas V 500 series and HLV.

#### **A.2.4.5 Atlas Booster Cylindrical Interstage Adapter**

The Atlas booster cylindrical ISA provides the structural attachment between the Atlas booster and the Centaur interstage adapter in the 500 Series configuration. After final assembly, the Atlas booster ISA provides the second of two LV attach points via stiff link to the launch platform. It is constructed from an aluminum rolled-ring forging. The Atlas booster cylindrical ISA is used on the Atlas V 500 series and HLV.

#### **A.2.5 5-Meter Diameter Payload Fairing Boattail Assembly**

The 5-m PLF boattail assembly provides the transition structure between the 3.8-m (12.5-ft) diameter Centaur interstage adapter and the 5-m diameter PLF modules. It is a composite structure of graphite-epoxy facesheets over an aluminum honeycomb core. The 5-m PLF boattail assembly is used on the Atlas V 500 series and HLV.

#### **A.2.6 Centaur Forward Load Reactor**

The Centaur Forward Load Reactor (CFLR) is attached to the Centaur forward adapter and provides load sharing between the Centaur structure and the 5-m PLF. The CFLR is installed between the Centaur and the 5-m PLF base module before SC mate. The CFLR also accommodates work access platforms inside the PLF. The CFLR is used on the Atlas V 500 series and HLV.

#### **A.2.7 Common Centaur Major Characteristics**

The Atlas V 400 and 500 series configurations and HLV use a stretched version of the flight-proven Centaur flown on Atlas III, which has the capability to be configured as a single- or dual-engine Centaur (SEC or DEC) depending on mission requirements. The common Centaur was flown on Atlas IIIB and currently on Atlas V and has a 1.7-m (5.5-ft) stretch in tank length for added performance compared to the Atlas IIAS Centaur. The Common Centaur uses the RL10A-4-2 engine with the nozzle extension in the fixed position before flight.



### A.2.7.1 Structure

The Centaur structural system consists of three major structural elements: the propellant tank, Centaur forward adapter, and propellant tank insulation.

**Propellant Tank** — The propellant tank structure provides primary structural integrity for the Centaur vehicle and support for all Centaur airborne systems and components (Figure A.2.7.1-1). A double-wall, vacuum-insulated intermediate bulkhead separates the propellants. The tanks are constructed of thin-wall fully monocoque corrosion-resistant steel. Tank stabilization is maintained by internal pressurization.

For DEC configurations, the engines are mounted directly to the propellant tank aft bulkhead. The SEC incorporates an engine support beam that attaches to the aft bulkhead in the existing engine mount locations, but provides centerline mounting of the single engine 452-mm (17.5-in.) aft of the dual-engine location. Redesigned thrust vector control actuator supports were incorporated.

**Centaur Forward Adapter** — The Centaur Forward Adapter (CFA) combines the functions of the stub adapter and equipment module used on earlier Atlas configurations into a single, more producible structure that provides mounting for avionics components, electrical harnesses, and the forward umbilical panel (Figures A.2.7.1-2 and A.2.7.1-3). The LV adapter bolts to the forward ring of the CFA. The CFA's load carrying capability has been enhanced so it can react the loads required by any SC likely to be flown on any Atlas V configuration. Localized structure improvements and the use of aluminum-lithium stringers provide a cost and mass efficient structural enhancement without requiring requalification of the avionics hardware mounted on the CFA.

Figure A.2.7.1-1: Monocoque Centaur Tank



Figure A.2.7.1-2: Centaur Forward Adapter Interface

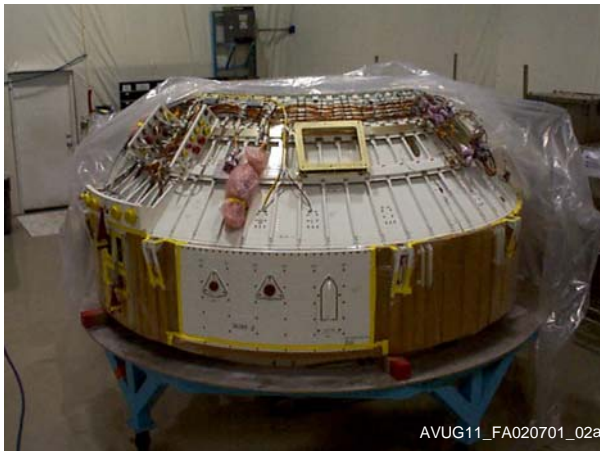
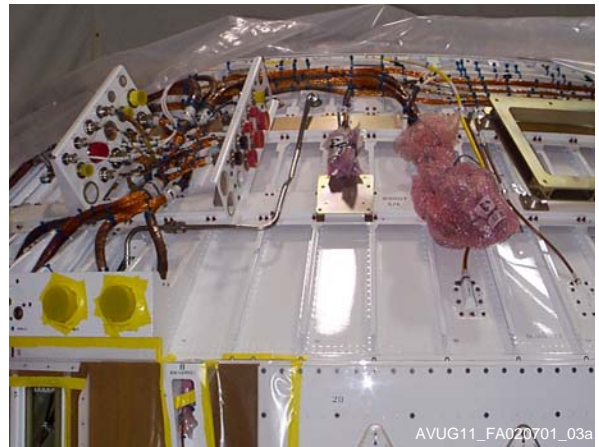


Figure A.2.7.1-3: Centaur Forward Adapter Avionics



**Propellant Tank Insulation** — Centaur propellant tank insulation minimizes ice formation and Liquid Oxygen (LO<sub>2</sub>) and Liquid Hydrogen (LH<sub>2</sub>) boil-off on the ground and during atmospheric ascent. It consists of foam insulation bonded to the exterior surface of the LH<sub>2</sub> and LO<sub>2</sub> tanks (Figure A.2.7.1-4).

#### A.2.7.2 Pneumatics

The pneumatic system controls tank pressure, provides reaction control and engine control bottle pressure, and provides in-flight purges. The pneumatic system consists of the Centaur vent and pressurization system, helium supply system, and purge supply system.

**CVAPS** — The Centaur Vent and Pressurization System (CVAPS) maintains the ullage tank pressures to ensure structural integrity. It prevents tank underpressure or overpressure, maintains the structural integrity of the intermediate bulkhead, and ensures positive suction pressure to the Centaur engine(s). The CVAPS is a software-based, fault-tolerant, closed-loop tank pressure control system. Three redundant ullage transducers in each tank measure pressure for the FTINU. The FTINU commands either pressurization or venting to achieve the desired tank pressure profile. Pressurization control is affected by locking the LO<sub>2</sub> and LH<sub>2</sub> vent valves and cycling the fault-tolerant pressurization solenoid valves. Vent control is active during boost phase and Centaur coast phases by cycling the LH<sub>2</sub> solenoid vent valve or unlocking the LH<sub>2</sub> or LO<sub>2</sub> self-regulating vent valves.

**Helium Supply System** — The baseline configuration requires two 135.4-cm (53.3-in.) by 58.4-cm (23-in) cylindrical composite helium storage bottles charged to 27,580 kPa (4,000 psi). The helium bottles are graphite-epoxy overwrapped with an Inconel metallic liner that provides leak-before-burst capability. A pressure regulator provides 3,450-kPa (450-psig) helium for engine and reaction control system controls. The two helium storage bottles provide ample helium for launch of direct ascent and first descending node geosynchronous transfer trajectory missions. This complement of bottles is used on all Atlas V GTO class missions. For longer coast duration missions, additional helium capacity can be installed, as required.

**Purge Supply System** — This dedicated airborne system provides helium purge gas to critical components to prevent air and moisture injection and freezing through the Atlas V boost phase.

#### A.2.7.3 Propulsion

The Centaur propulsion system uses LH<sub>2</sub> and LO<sub>2</sub> propellants. Primary propulsion is provided by Pratt & Whitney RL10A-4-2 engine(s) with a fixed, radiatively cooled nozzle extension.

Figure A.2.7.1-4: Centaur Tank Foam Insulation

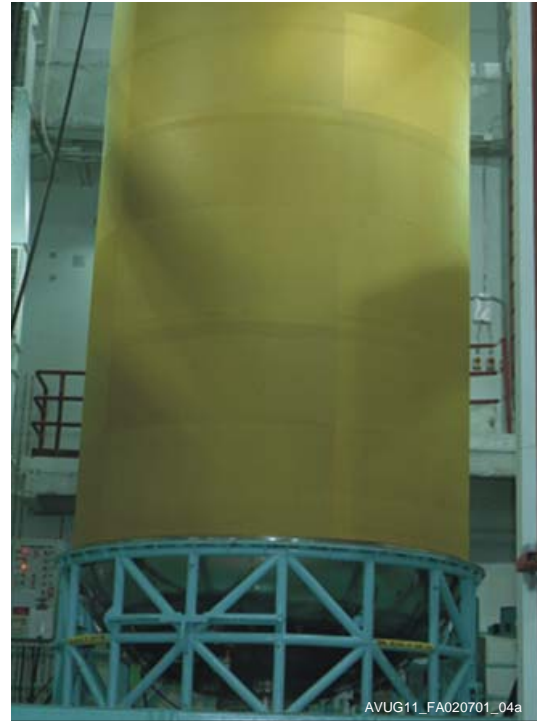


Figure A.2.7.3-1: RL10A-4-2 Engine





**Main Engine(s)** — The RL10A-4-2 engine is a gimbaled, turbopump-fed, and regeneratively cooled and consists of a fixed primary nozzle and a secondary nozzle extension (Figure A.2.7.3-1). The 51-cm (20-in.) long columbium fixed extended nozzle provides enhanced engine performance through an increase in nozzle expansion ratio. Engine prestart and start functions are supported by supplying pressure-fed propellants to the engine pumps (Figure A.2.7.3-2 for the DEC, Figure A.2.7.3-3 for the SEC). The engine(s) provide pitch, yaw, and roll (DEC only) control during powered phases of flight. The RL10A-4-2 engine develops a thrust of 99.2 kN (22,300 lbf) at a specific impulse of 450.5 seconds.

**Reaction Control System** — The hydrazine-based Reaction Control System (RCS) provides pitch, yaw, and roll control for Centaur during coast phases of flight and provides propellant settling during the coast up through Centaur main engine start. The SEC Centaur also uses the RCS during powered phases of flight to perform roll control. The RCS is located on the Centaur aft bulkhead providing fault-tolerant control and avoiding contamination of the SC when used.

**Centaur Thrust Vector Control System** — The Thrust Vector Control (TVC) system consists of an Electronic Control Unit (ECU) and two Electromechanical Actuators (EMA) for thrust vector control of the engine. In the fault tolerant avionics configuration, DEC Centaur utilizes a dual ECU/EMA system.

Figure A.2.7.3-2: Atlas V Dual Engine Centaur Propulsion System

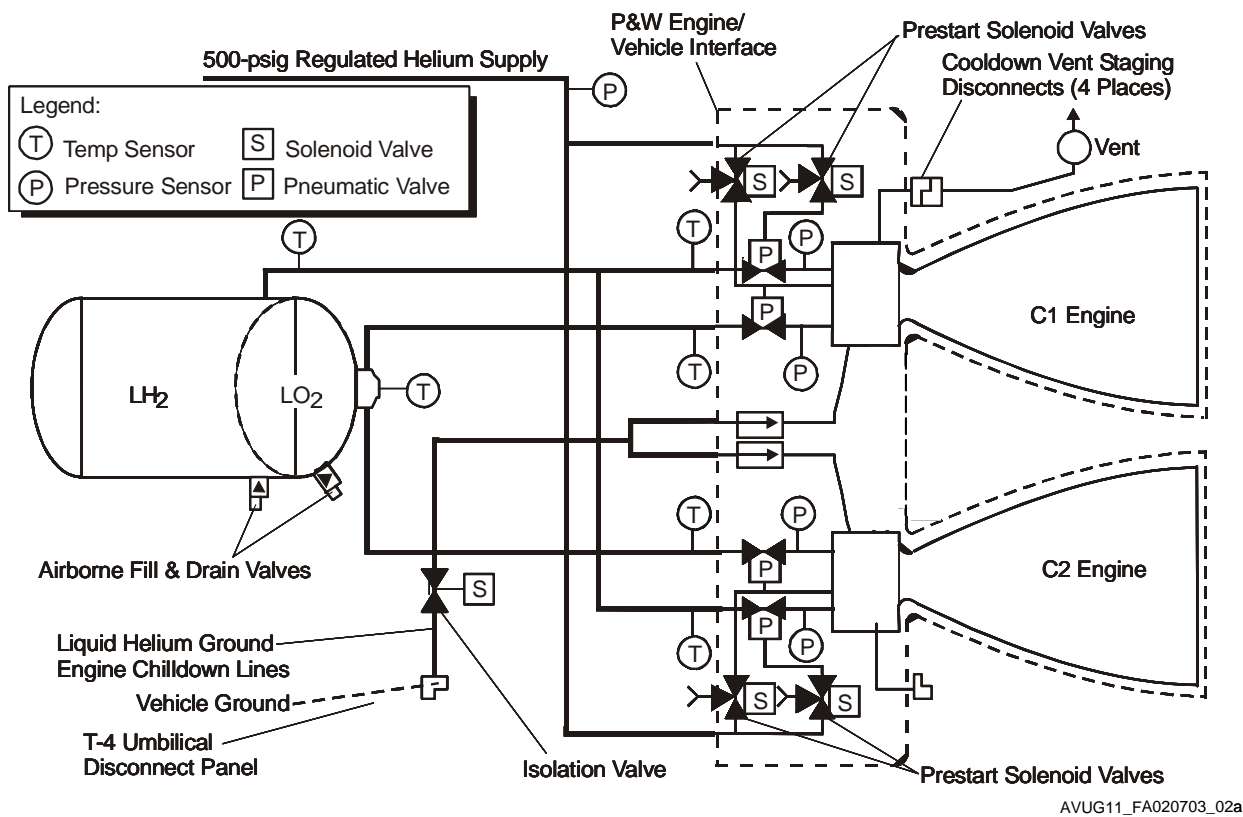
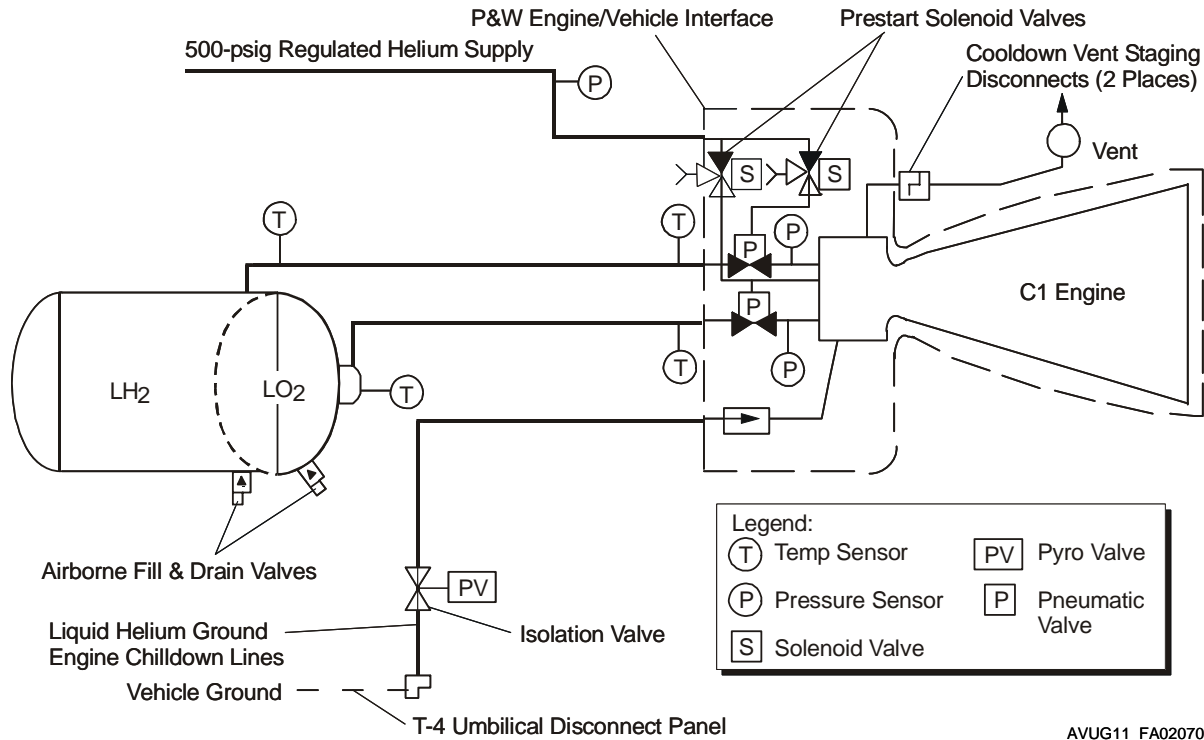


Figure A.2.7.3-3: Atlas V Single Engine Centaur Propulsion System



AVUG11\_FA020703\_03a

#### A.2.7.4 Atlas V Avionics

##### A.2.7.4.1 Booster Avionics

On the Atlas booster, redundant main batteries have been incorporated in the design. Fault-Tolerant Inertial Navigation Unit (FTINU) inputs are now routed to the BRCU and sent to the INU over the 1553 data bus. Identical to Centaur, the Pyrotechnic Controllers (PYCs) have been replaced by ORCAs for all pyrotechnic events. Two ORCAs and two dedicated pyrotechnic batteries are provided in a redundant design. The Atlas Flight Termination System (FTS) has been replaced by the Automatic Destruct System (ADS), a system that senses inadvertent stage separation and autonomously commands destruct (the existing Centaur capability is maintained).

##### A.2.7.4.2 Centaur Avionics

The Centaur avionics (INU/CRCU/ECU/MDU/RDU) were maintained from Atlas III for the first 13 Atlas V vehicles with the exception of the PYCs replacement by ORCAs for all pyrotechnic events. The ORCA is a 30-channel, sequenceable-output, three-inhibit pyrotechnic controller, which is under FTINU control through the 1553 data bus. Two ORCAs and two dedicated pyrotechnic batteries are provided in a redundant design. Also, the Main Vehicle Battery (MVB) has been upgraded for capacity.

A significant example of added redundancy is the new FTINU developed by Honeywell for service on Atlas V since mid 2005 that replaced the existing Internal Navigation Unit (INU). This component provides enhanced mission accuracy and redundancy through a fully fault-tolerant pentad of ring laser gyros as well as a dual-channel processor system, arranged in an active/hot-spare architecture. The FTINU also houses and executes the flight software to guide and control the vehicle through its mission.

In addition to the new FTINU, the Upper Stage Remote Control Unit (URCU) is incorporated in the fault-tolerant avionics design also providing redundancy. This unit is similar to the existing CRCU (providing power and switching control) but is arranged in a redundant, channelized architecture to provide fault

tolerance. A second MVB is also incorporated to provide power system redundancy. Analog and discrete inputs are now routed to the URCU and sent to the FTINU over the 1553 data bus.

The remaining basic functions of the Atlas V fault tolerant avionics system are unchanged in design from Atlas V current avionics system (e.g., PU, EMA TVC, etc). Evolution of the Atlas V vehicle avionics system is depicted in Figure A.2.7.4.2-1.

Centaur avionics are flight-proven subsystems consisting of guidance, navigation and flight control, telemetry and tracking, secure flight termination capability, and electrical power distribution (Figure A.2.3.4.2-1). These systems control and monitor all vehicle functions during prelaunch and flight and are line-replaceable in the field.

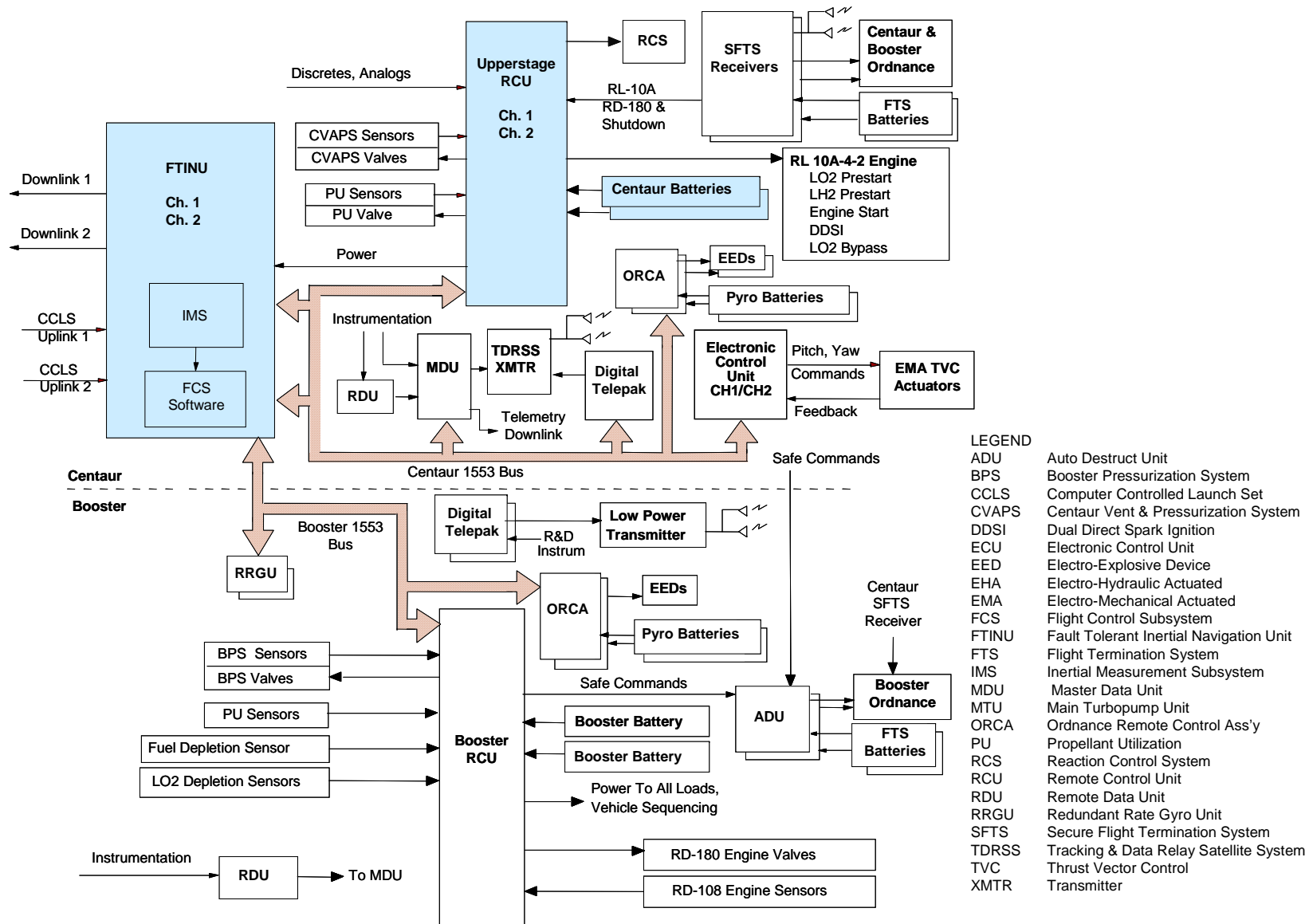
**Flight Control Subsystem** — The Centaur configured with the fault tolerant avionics uses the new FTINU and URCU for added reliability and redundancy. The FTINU is a fault-tolerant upgrade to the INU with redundant IMS and FCS processors and an inertial sensor assembly that consists of five rate gyros and five accelerometers to provide fault-tolerant inertial measurements. The ring laser gyro system provides high accuracy rate measurements for processing by the flight computer. The strap-down Inertial Measurement Subsystem (IMS) provides the FCS incremental timing pulses from a precision timing reference, incremental velocity pulses from the accelerometers, and body-to-inertial attitude quaternion data. The single FTINU contains redundant hardware in channels 1 and 2. One channel controls the vehicle, and the other monitors the data so that it can take over if a switchover is required. Each channel contains an IMS and a FCS. Both the IMS and FCS are MIL-STD-1750A processors.

The IMS measures vehicle rotation and acceleration and sends that information to the FCS. The FCS performs all vehicle required computations, including guidance, navigation, attitude control, sequencing and separation fire commands, propellant utilization control, and tank pressurization control. Input to the FCS includes incremental velocities and time, quaternion information, booster rate data, booster and Centaur tank pressures and PU data. Output from the FCS includes command of 96 solid-state switches per channel in the URCU and 64 solid-state switches in the booster RCU. Based on commands from the FTINU, the RCUs control all vehicle sequencing events: RCS, engines, pressure control, TVC and propellant depletion

The FCS performs all attitude control, guidance, and navigation computations for both the Atlas V booster and Centaur phases of flight. FCS commanded open-loop pitch and yaw steering occurs during the early Atlas V booster phase based on winds-aloft measurements taken shortly before launch. Closed-loop guidance steering is then initiated to provide guidance steering based on the mission trajectory requirements.

**Telemetry and Tracking** — The Atlas V telemetry Data Acquisition System (DAS), shown in Figure A.2.7.4.2-2, monitors several hundred vehicle parameters in addition to Guidance and Navigation (G&N) data before launch and throughout all phases of flight. Critical vehicle parameters are also monitored via hardwired landline instrumentation. Measurements include acceleration, vibration, temperatures, pressures, displacement, currents and voltages, engine pump speeds, and discretes. The programmable data acquisition telemetry system consists of a Master Data Unit (MDU) and two Remote Data Units (RDUs), one on the Atlas V booster and one on the aft end of Centaur. The MDU, located on the Centaur forward adapter, provides transducer excitation, signal conditioning, and encoding for all Centaur front-end measurements in addition to receiving and formatting data from the FTINU and two RDUs. The FTINU provides data to the MDU over the 1553 data bus. The MDU provides two Pulse-Code Modulation (PCM) outputs; one is connected to the Radio Frequency (RF) transmitter, the other is used to provide a hard-line umbilical link. The C-band tracking system aids in determining the real-time position of the LV for launch site Range Safety tracking requirements. The airborne transponder returns an amplified RF signal when it detects a tracking radar interrogation. The baseline system consists of a noncoherent transponder, a power divider, and two antennas. The Centaur C-band tracking system meets requirements of Eastern and Western Ranges.

Figure A.2.7.4.2-1: Centaur Fault Tolerant Avionics System

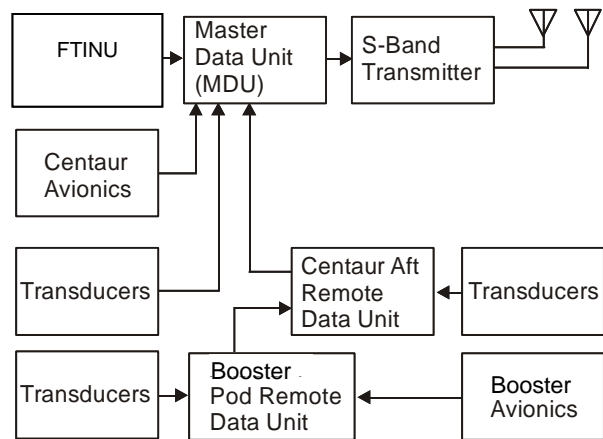


AVUG11\_FA02070402\_01b

**Flight Termination System** — The Centaur Secure Flight Termination System (SFTS) provides the capability for termination of Centaur flight in case of an in-flight malfunction. The Centaur SFTS is independent of controls of other vehicle systems and from the booster FTS. This system has redundancy and is approved for launches at CCAFS and Vandenberg Air Force Base (VAFB). The secure receiver responds only to high-alphabet code word messages. These messages command engine shutdown, vehicle destruct, and system disable. A SC destruct system can be added, if required, to disable the propulsive capability of the SC. A conical-shaped destruct charge in the payload adapter can be directed at the SC propulsion system. Figure A.2.7.4.2-3 illustrates the Centaur SFTS.

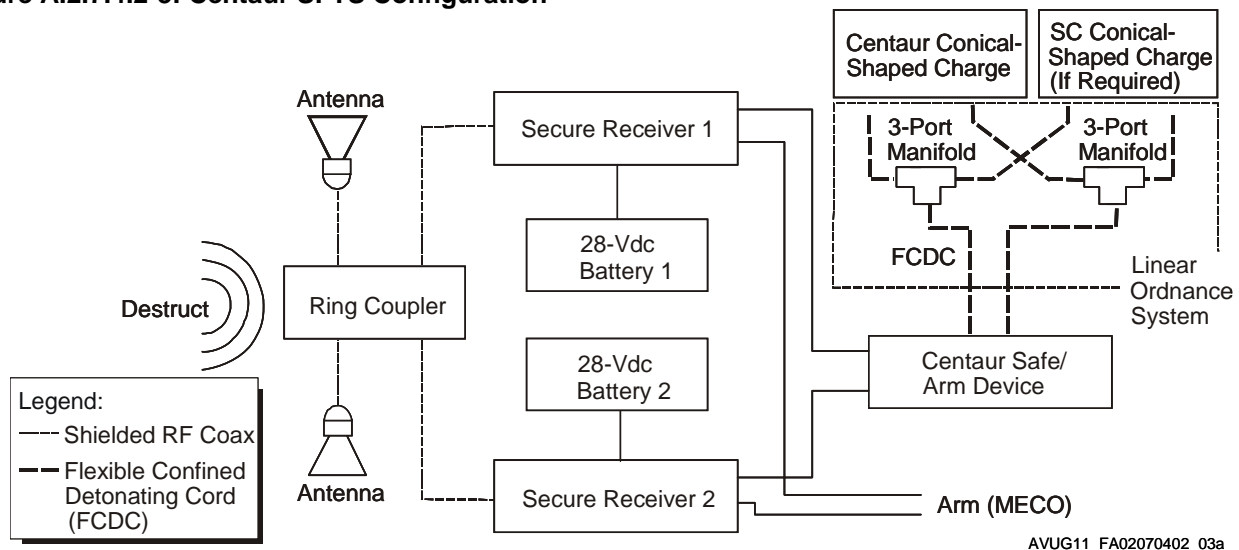
**Electrical Power System** — In the current avionics configuration, the electrical power system consists of two 28 Vdc main vehicle batteries, two pyrotechnic batteries, the URCU, a single-point grounding system, and associated electrical harnesses. The URCU provides 96 outputs (per channel) of solid-state switching under FTINU software control via a MIL-STD-1553B data bus. The URCU also provides power changeover capabilities from ground power to internal main vehicle battery power to meet power distribution requirements. Electrical harnesses provide interconnect wiring for avionics equipment with other Centaur systems, interconnections between booster and Centaur, power distribution, command, and telemetry signal paths.

**Figure A.2.7.4.2-2: Telemetry Data Acquisition System Configuration**



AVUG11\_FA02070402\_02a

**Figure A.2.7.4.2-3: Centaur SFTS Configuration**



AVUG11\_FA02070402\_03a

**Propellant Utilization** — The Centaur Propellant Utilization (PU) system ensures that an optimum mixture of LH<sub>2</sub> and LO<sub>2</sub> residuals remain in the Centaur propellant tanks at the end of the mission. The PU system continuously measures the mass of the remaining propellants using three redundant externally mounted differential pressure transducers, which are connected to each of the LH<sub>2</sub> and LO<sub>2</sub> tanks to measure propellant head pressure. FTINU software converts this head pressure to mass and calculates the sensed mass imbalance between the two tanks. The FTINU, through the URCU, then commands the redundant RL10 engine oxygen flow control valve actuator to correct the sensed error by changing the engine mixture ratio.

**Propellant Level Indication System** — The Centaur Propellant Level Indication System (PLIS) is used during tanking operations to indicate levels of fuel and oxidizer in the propellant tanks. The system consists of cold wire sensors near the top of the propellant tanks and associated hardware for ground control and display. The sensors prevent underloading and overloading of propellants.

### A.2.7.5 Centaur Geosynchronous Orbit Kit

Centaur's primary mission role in recent years has been the launch of geosynchronous communications SC. Centaur has mass-optimized electrical power, thermal control, and fluids management hardware to enable maximum performance for these types of missions. A Geosynchronous Orbit Kit (GSO Kit) has been designed and manufactured to provide Centaur extensions in electrical power and fluid management capabilities required to extend mission duration to meet mission unique SC requirements. The GSO Kit adds radiation shielding on the LO<sub>2</sub> tank side wall; and Centaur's avionics and electrical components are covered with special thermal paints, tapes, and additional radiation shielding to maintain their operating temperatures. Minor modifications to the Centaur aft bulkhead were incorporated to allow "kit-able" installation of the GSO Kit.

A GSO Kit for extended missions to GSO typically accommodates 3-burns and mission-unique extended coast time. This GSO Kit includes two additional (for a total of four) 150 AH batteries and LH<sub>2</sub> tank sidewall radiation shielding.

### A.2.8 Atlas V Payload Fairings

The PLF protects all components forward of the Centaur from liftoff through atmospheric ascent. A variety of PLF options are available (Sections 4 and 6). For example, the Atlas V 400 series combines the Atlas booster with the LPF, the EPF or the XEPF. The Atlas V 500 series combines the Atlas booster with a larger 5-m class diameter PLF that is available in short, medium or long sizes to accommodate SC volume growth. The Atlas V 500 series PLF is a derivative of a flight-proven composite PLF manufactured by Ruag Space, Switzerland. See section 6 for more information on payload fairings.

### A.2.9 Spacecraft and Launch Vehicle Interface Accommodations

Section 5 and 9 discusses the variety of payload adapters ULA offers to meet LV/SC interface requirements.

## A.3 ATLAS AND CENTAUR PRODUCTION AND INTEGRATION

ULA provides a combination of experienced production leadership and a production organization dedicated to continuous process improvement supported by state-of-the-art computerized management systems. Our site management concept encourages personnel at each location to concentrate on attaining their respective goals to achieve overall program milestones.

The Atlas V LV uses common processes and hardware with kits to support mission-unique requirements. Proven manufacturing processes are used to minimize the variability of quality, schedule, and cost. Each production element is focused on continuous improvement through assessment of current process results, identification of root cause, and implementation of improvements.

Manufacturing processes are continuously selected and analyzed for improvement opportunities leading to cycle-time reduction, cell manufacturing, design improvements, producibility improvements, and process improvements. This is typically done using a Kaizen event format. Examples of these improvements include welded engine gimbal mounts, pressure-assisted cryogenic seals, elliptical forward bulkhead, common tank structure for Atlas V Centaurs, near-real-time digital x-ray, cellular manufacturing centers, reduced parts count, and reduced tooling.

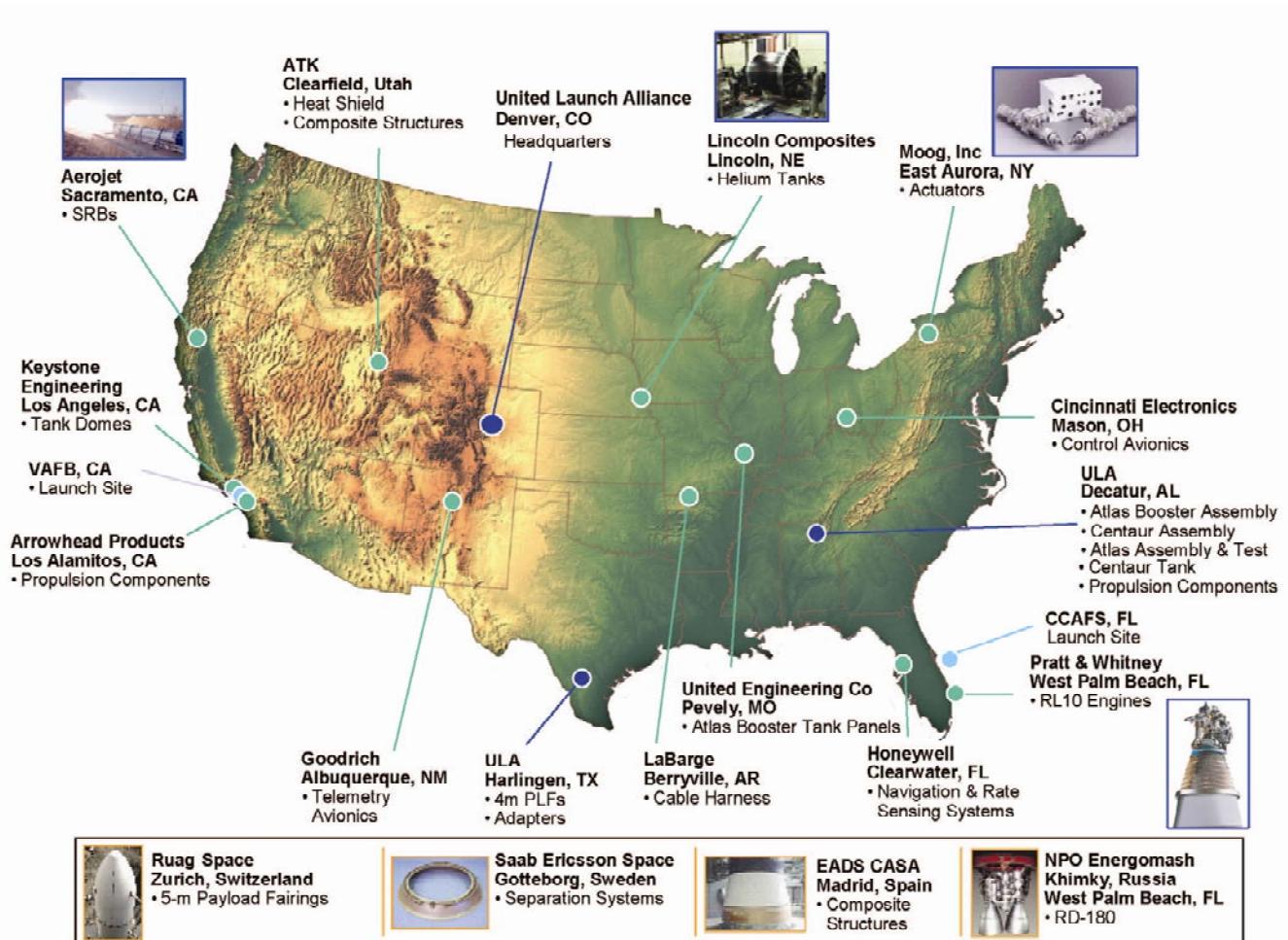
Lessons learned from each manufactured vehicle are analyzed and improvements are scheduled for change implementation on future vehicles.

### A.3.1 Organization

The manufacturing process of the Atlas V LV uses an extended enterprise to focus on the key competencies of each supplier shown in Figure A.3.1-1. This approach enables each supplier to focus on their area of expertise resulting in providing quality products at a competitive price. Assemblies are provided to the final assembly facility for integration, test, and delivery to the launch sites. Each is structured as an integral part of the manufacturing flow, focused on specific key competencies.



Figure A.3.1-1: Extended Enterprise



AVUG11\_FA0301\_01h

At the beginning of 2009, ULA had five production facilities (Denver, CO; San Diego, CA; Harlingen, TX; Huntington Beach, CA; Decatur, AL) dedicated to Atlas V and Delta IV production, encompassing 2.6 million square feet of space. An essential element of the ULA concept of operations is the consolidation of ULA's production operations. The objectives of this consolidation are to improve utilization of ULA facilities, implement common, more robust processes across the entire enterprise and increase operational efficiencies that will result in overall savings. Over three years, this consolidation will result in two production facilities and 1.8 million square feet of space. Atlas V booster and Centaur upper-stage hardware production in Denver, CO and San Diego, CA will be systematically transferred to the ULA factory in Decatur, AL, and integrated with Delta II and Delta IV production lines while Harlingen, TX will continue to perform subassembly, intermediate, and final assembly tasks on major Atlas V and Delta IV LV structures. To ensure continued mission success during the production transition to Decatur, ULA created a detailed production plan that will allow overlap with production and assembly operations over the multiple locations, until such time that hardware production capabilities have been validated at the Decatur factory.

Overall accountability for Atlas V production quality, schedule, and cost lies with ULA Production Operations. Within this organization are all production sites and core support functions of material planning, manufacturing engineering, acquisition management, environmental management, and business management.

### A.3.1.1 Harlingen Facility, Harlingen, TX

The Harlingen facility has a diverse array of technical expertise and equipment that permits complete in-house fabrication and assembly of major structures (Figure A.3.1.1-1). The facility has implemented total quality management, is certified to ANSI/ISO/ASQC 9002, and practices continuous improvement to achieve a high level of quality that results in significant reductions in rework and rejection.

The facility performs subassembly, intermediate, and final assembly tasks on major structures for Atlas V LVs. Harlingen operations provides the following components for the Atlas V product line: Centaur forward adapter; 400 series interstage adapter; 4-meter payload fairing and boattail (400 series); Centaur aft stub adapter (400/500 series); conical interstage adapters (500 series); final assembly of the cylindrical ISA, and Atlas Booster ATS; and Atlas Booster Intertank Skirts (Figure A.3.1.3-3). The key processes for this site are hole drilling and fastener installation (Figure A.3.1.3-2). Harlingen ships its products to San Diego, CA; Denver, CO; launch sites and soon Decatur, AL for final assembly.

Figure A.3.1.1-1: Harlingen Operations



Figure A.3.1.3-2: Harlingen Key Process



- Hole Drilling/Fastener Installation
- Proven on Atlas II/III
  - Improved Tooling
  - One Minor Hole/Fastener N/C on First Three Atlas V Skirts
  - History of Continuous Improvement





Figure A.3.1.3-3: Harlingen Production



Centaur Forward Adapter



Atlas 4-m Boattail



Atlas V Adapter Skirt



Atlas V ATS



Atlas 4-m PLF

AVUG11\_FA030103\_03a

### A.3.1.2 Decatur Facility, Decatur, AL

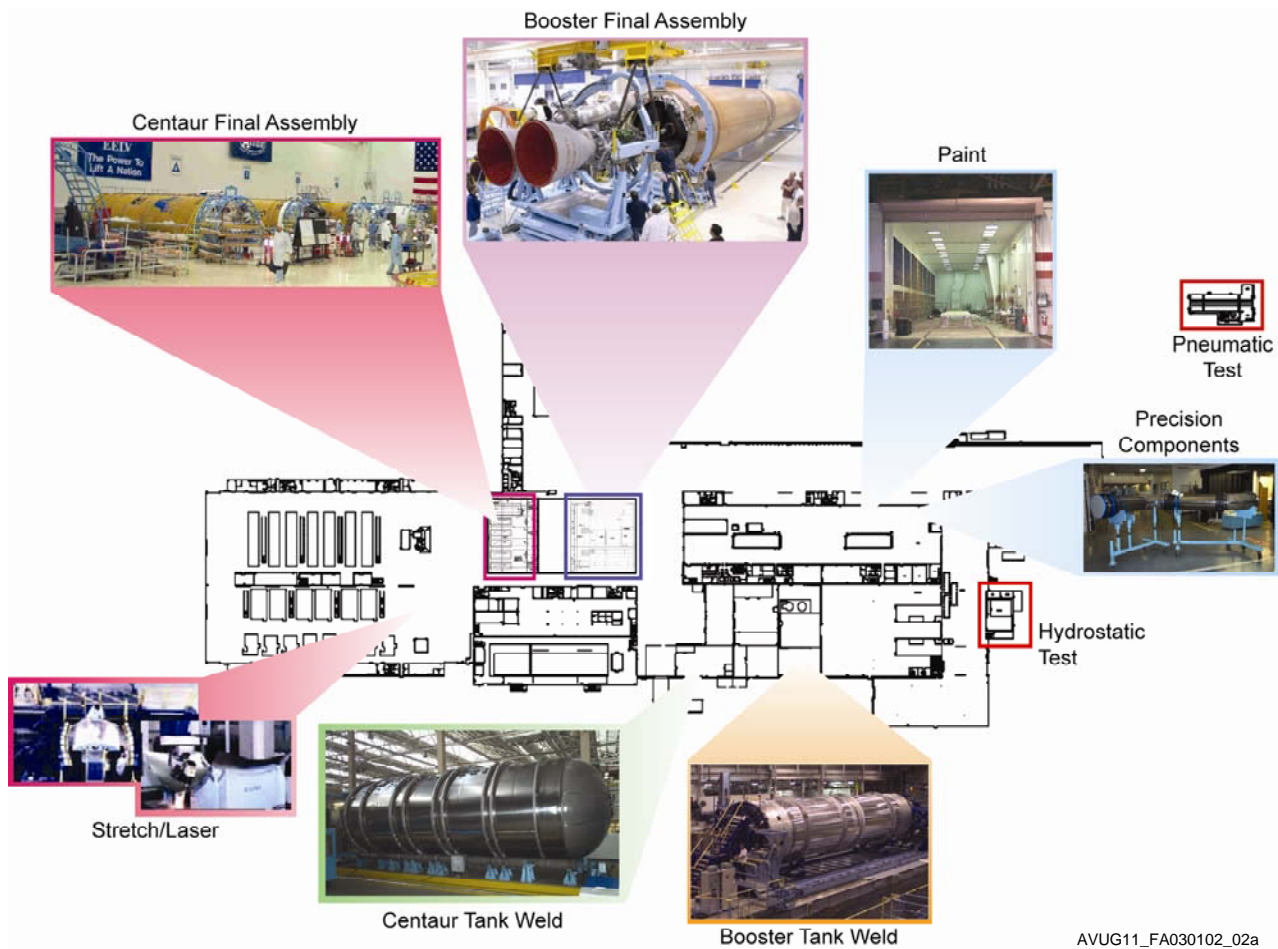
The Decatur facility has a diverse array of technical expertise and equipment that permits in-house fabrication and final assembly the Atlas Booster and the Centaur Upper Stage (Figure A.3.1.2-1). The facility has implemented total quality management, is certified to ANSI/ISO/ASQC 9002, and practices continuous improvement to achieve a high level of quality that results in significant reductions in rework and rejection.

The Decatur facility performs subassembly, intermediate, and final assembly tasks on major structures for Atlas V LVs. Decatur operations builds and then integrates the following components for the Atlas V program: Atlas V Booster fuel and oxidizer tank weldments; Centaur's common-bulkhead stainless-steel tank structure; and Booster and Centaur fuel and oxidizer feedline components. The key processes for this site include welding operations, hole drilling, Avionics/cabling installation, fastener installation, corrosion control, and insulation installation/application operations (Figure A.3.1.3-2). The Decatur Facility ships its products to the launch sites at Cape Canaveral Air Force Station, Florida and Vandenberg Air Force Base, California for final integration and launch operations.

Figure A.3.1.2-1: Decatur Operations



Figure A.3.1.2-2: Decatur Production



### A.3.1.3 Cape Canaveral Air Force Station, FL

CCAFS is the final destination of the Atlas V hardware for East Coast launches. CCAFS concentrates on the final vehicle integration and system checks before launching the vehicles. See Section 7 for details on the Atlas V launch sites.

### A.3.1.4 Vandenberg Air Force Base, CA

VAFB is the final destination for the Atlas V hardware for West Coast launches. VAFB concentrates on final vehicle integration and system checks before launching vehicles. See Section 7 for details on the Atlas V launch sites.

### A.4 VEHICLE RELIABILITY PREDICTIONS

For Atlas V, the design philosophy for reliability is controlled by fault avoidance and fault tolerance. Fault avoidance focuses on component selection, reduction in number of critical subsystems, single point failure minimization, and lessons learned. Examples of fault avoidance are:

1. Reduction in the number of critical subsystems
2. Reduction in the number of staging events
3. Reduction in overall parts count
4. Booster main engine health check before launch
5. Structurally stable booster
6. No SRB thrust vector control
7. No SRB joints

**Table A.4-1: Typical Atlas V Reliability Predictions — GTO Mission Profile**

Atlas V Vehicle Configuration	Design Reliability	Mission Reliability
AV-401	0.9954	0.9867
AV-531	0.9932	0.9828
AV-551	0.9916	0.9804

The Atlas V program has designed out significant failure modes that are present in other LVs that are at the edge of their performance margins.

Fault tolerance focuses on designing the vehicle to achieve mission success despite the possible existence of faults. Though there are no formal requirements beyond the primary reliability requirement for the overall LV, fault tolerance is incorporated through redundancy in both the hardware and software as well as through the general design process. Examples of Atlas V fault tolerance are:

1. RL10 engine dual direct spark ignition
2. Fault Tolerant Inertial Navigation Unit (Fault Tolerant Avionics Configuration)
3. Redundant avionics interfaces for control of engine functions
4. Redundant booster control systems
5. Booster Remote Control Unit dual redundant power input
6. Redundant rate gyro unit
7. Error correcting code
8. URCU and Dual Redundant Power Input (Fault Tolerant Avionics Configuration)

With the system design based on common hardware elements (and requirements that are derived and verified by qualification and acceptance testing), the final design encompasses all requirements across all vehicle configurations and missions. The robustness that is achieved from this design approach enables the system to fly through some failures using the available excess performance, stability margin, and structural margin.

Table A.4-1 summarizes the reliability predictions for Atlas V based on this design approach. ULA performs these predictions for all flight and ground subsystems required for launch and mission success during the time from launch commit through the completion of Centaur Collision Avoidance Maneuver (CCAM). For the Atlas V program, reliability predictions are defined at two levels: design reliability and mission reliability. Design reliability predictions account for potential mission failure modes that have their genesis in the design of system hardware. The failure rates used to calculate design reliability are derived from MIL-HDBK-217 (Reliability Predictions for Electronic Equipment), Reliability Analysis Center Non-electronic Parts Reliability Database (NPRD-95), and subcontractor data. Mission reliability on the other hand, includes design reliability as well as failure modes introduced by manufacturing processes, assembly, test, and system integration. Mission reliability is calculated by performing a Bayesian Update using historical flight data from existing and heritage Atlas, Titan, and Centaur vehicles and vehicle stages. Because flight data contain all potential failure modes (both design and process related), the mission reliability is the better estimate of the true reliability of the flight hardware.

In summary, the evolutionary foundation of the Atlas V program optimizes system reliability and overall vehicle robustness to continue the strong Atlas tradition of mission success.

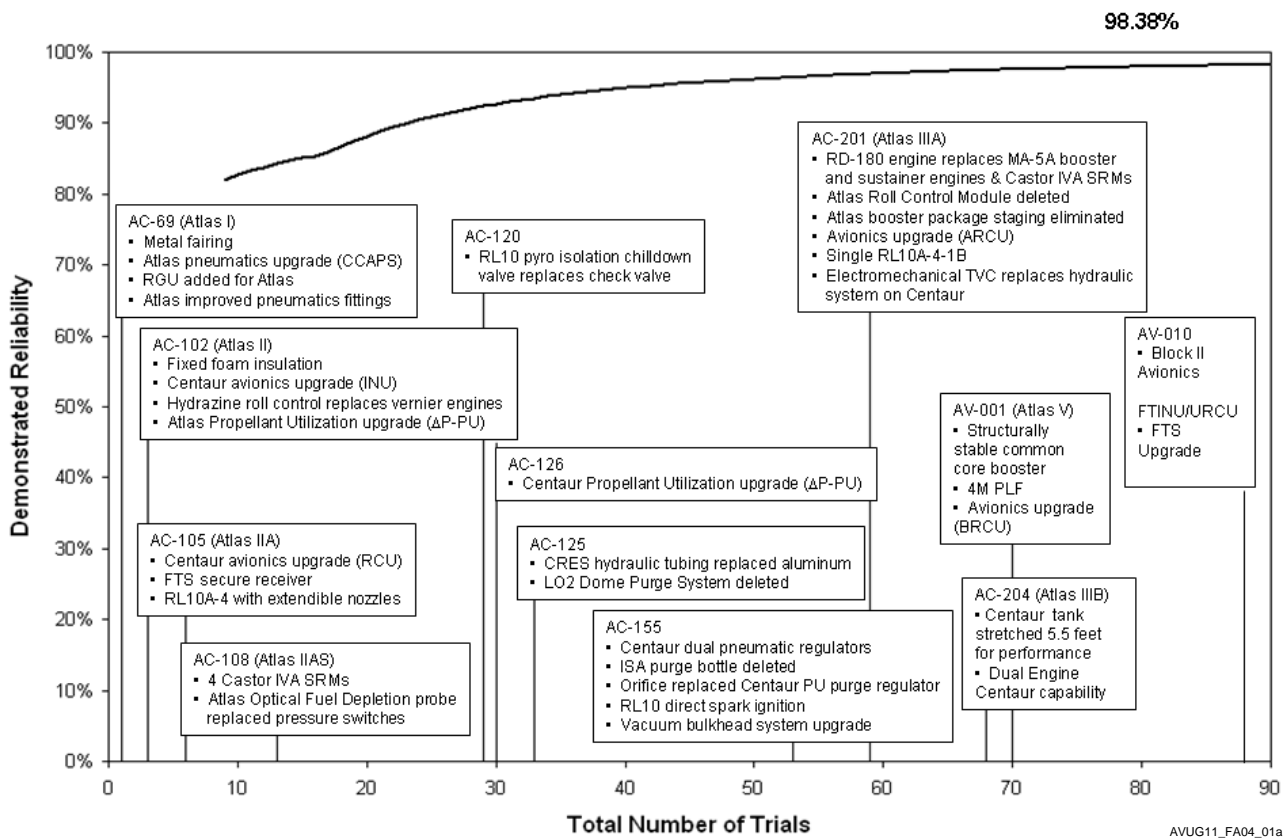


### A.4.1 Vehicle Reliability Growth

The Atlas V LV development and evolution has implemented various vehicle and process enhancements to increase vehicle performance and operability. These enhancements have also increased vehicle reliability. The reliability growth model developed by J. T. Duane is the analysis method used by ULA to calculate vehicle reliability growth over time. This method uses demonstrated flight data to predict the future performance of the Atlas launch system (Figure A.4-1). The conservative Reliability Growth Model is based on observations of the reduction in failure rate as the cumulative number of missions increases. When mean missions between flight failures are plotted on a log-log scale against the cumulative missions flown, data points fall approximately in a straight line. The steepness of the slope of this line gives a measure of the growth rate of improvements in reliability over time. For the Atlas Program, the high value achieved is associated with performance upgrades of our operational LVs. This growth rate is the result of our vigorous failure analysis and corrective action system, and our focus on controlling processes. ULA expects a high probability of mission success occurrence by using only proven hardware of high inherent design reliability and processes that are controlled and stable.

Atlas/Centaur demonstrated reliability record of 0.9838 (Duane Reliability Growth Method) is based on flight history through the fifteenth flight of the Atlas V LV (Figure A.4-1). This record is based on, successful launches and SC system support. For ULA, it represents the pride our personnel take in playing an integral part in successful heritage space programs for more than 35 years.

**Figure A.4-1: Atlas/Centaur Reliability (Duane Reliability Growth Method) Through Atlas V 15th Flight**



AVUG11\_FA04\_01a

Table A.1-1: Atlas/Centaur Launch History

Date	Mission	Vehicle	LV Type	Mission Type	LV Results
<b>1962</b>					
May 8	R&D	AC-1	LV-3C/A	R&D	Failure
<b>1963</b>					
November 27	R&D	AC-2	LV-3C/B	R&D	Success
<b>1964</b>					
June 30	R&D	AC-3	LV-3C/C	R&D	Failure
December 11	R&D	AC-4	LV-3C/C	R&D	Success
<b>1965</b>					
March 2	R&D	AC-5	LV-3C/C	R&D	Failure
August 11	R&D	AC-6	LV-3C/D	R&D	Success
<b>1966</b>					
April 7	R&D	AC-8	LV-3C/D	R&D	Failure
May 30	Surveyor	AC-10	LV-3C/D	Lunar Intercept	Success
September 20	Surveyor	AC-7	LV-3C/D	Lunar Intercept	Success
October 26	Mariner Mars	AC-9	LV-3C/D	Interplanetary	Success
<b>1967</b>					
April 17	Surveyor	AC-12	LV-3C/D	Lunar Intercept	Success
July 14	Surveyor	AC-11	LV-3C/D	Lunar Intercept	Success
September 8	Surveyor	AC-13	SLV-3C/D	Lunar Intercept	Success
November 7	Surveyor	AC-14	SLV-3C/D	Lunar Intercept	Success
<b>1968</b>					
January 7	Surveyor	AC-15	SLV-3C/D	Lunar Intercept	Success
August 10	ATS-D	AC-17	SLV-3C/D	GTO	Failure
December 7	OAO-A	AC-16	SLV-3C/D	LEO	Success
<b>1969</b>					
February 24	Mariner Mars	AC-20	SLV-3C/D	Interplanetary	Success
March 27	Mariner Mars	AC-19	SLV-3C/D	Interplanetary	Success
August 12	ATS-E	AC-18	SLV-3C/D	GTO	Success
<b>1970</b>					
November 30	OAO-B	AC-21	SLV-3C/D	LEO	Failure
<b>1971</b>					
January 25	INTELSAT IV	AC-25	SLV-3C/D	GTO	Success
May 8	Mariner Mars	AC-24	SLV-3C/D	Interplanetary	Failure
May 30	Mariner Mars	AC-23	SLV-3C/D	Interplanetary	Success
December 19	INTELSAT IV	AC-26	SLV-3C/D	GTO	Success
<b>1972</b>					
January 22	INTELSAT IV	AC-28	SLV-3C/D	GTO	Success
March 2	Pioneer F	AC-27	SLV-3C/D	Interplanetary	Success
June 13	INTELSAT IV	AC-29	SLV-3C/D	GTO	Success
August 21	OAO-C	AC-22	SLV-3C/D	LEO	Success
<b>1973</b>					
April 5	Pioneer G	AC-30	SLV-3D/D-1A	Interplanetary	Success
August 23	INTELSAT IV	AC-31	SLV-3D/D-1A	GTO	Success
November 3	Mariner Venus/Mercury	AC-34	SLV-3D/D-1A	Interplanetary	Success
<b>1974</b>					

Date	Mission	Vehicle	LV Type	Mission Type	LV Results
November 21	INTELSAT IV	AC-32	SLV-3D/D-1A	GTO	Success
<b>1975</b>					
February 20	INTELSAT IV	AC-33	SLV-3D/D-1A	GTO	Failure
May 22	INTELSAT IV	AC-35	SLV-3D/D-1A	GTO	Success
September 25	INTELSAT IVA	AC-36	SLV-3D/D-1AR	GTO	Success
<b>1976</b>					
January 29	INTELSAT IVA	AC-37	SLV-3D/D-1AR	GTO	Success
May 13	COMSTAR	AC-38	SLV-3D/D-1AR	GTO	Success
July 22	COMSTAR	AC-40	SLV-3D/D-1AR	GTO	Success
<b>1977</b>					
May 26	INTELSAT IVA	AC-39	SLV-3D/D-1AR	GTO	Success
August 12	HEAO-A	AC-45	SLV-3D/D-1AR	LEO	Success
September 29	INTELSAT IVA	AC-43	SLV-3D/D-1AR	GTO	Failure
<b>1978</b>					
January 6	INTELSAT IVA	AC-46	SLV-3D/D-1AR	GTO	Success
February 9	FLTSATCOM	AC-44	SLV-3D/D-1AR	GTO	Success
March 31	INTELSAT IVA	AC-48	SLV-3D/D-1AR	GTO	Success
May 20	Pioneer Venus	AC-50	SLV-3D/D-1AR	Interplanetary	Success
June 29	COMSTAR	AC-41	SLV-3D/D-1AR	GTO	Success
August 8	Pioneer Venus	AC-51	SLV-3D/D-1AR	Interplanetary	Success
November 13	HEAO-B	AC-52	SLV-3D/D-1AR	LEO	Success
<b>1979</b>					
May 4	FLTSATCOM	AC-47	SLV-3D/D-1AR	GTO	Success
September 20	HEAO-C	AC-53	SLV-3D/D-1AR	LEO	Success
<b>1980</b>					
January 17	FLTSATCOM	AC-49	SLV-3D/D-1AR	GTO	Success
October 30	FLTSATCOM	AC-57	SLV-3D/D-1AR	GTO	Success
December 6	INTELSAT V	AC-54	SLV-3D/D-1AR	GTO	Success
<b>1981</b>					
February 21	COMSTAR	AC-42	SLV-3D/D-1AR	GTO	Success
May 23	INTELSAT V	AC-56	SLV-3D/D-1AR	GTO	Success
August 5	FLTSATCOM	AC-59	SLV-3D/D-1AR	GTO	Success
December 15	INTELSAT V	AC-55	SLV-3D/D-1AR	GTO	Success
<b>1982</b>					
March 4	INTELSAT V	AC-58	SLV-3D/D-1AR	GTO	Success
September 28	INTELSAT V	AC-60	SLV-3D/D-1AR	GTO	Success
<b>1983</b>					
May 19	INTELSAT V	AC-61	SLV-3D/D-1AR	GTO	Success
<b>1984</b>					
June 9	INTELSAT VA	AC-62	G/D-1AR	GTO	Failure
<b>1985</b>					
March 22	INTELSAT VA	AC-63	G/D-1AR	GTO	Success
June 29	INTELSAT VA	AC-64	G/D-1AR	GTO	Success
September 28	INTELSAT VA	AC-65	G/D-1AR	GTO	Success
<b>1986</b>					
December 4	FLTSATCOM	AC-66	G/D-1AR	GTO	Success
<b>1987</b>					

Date	Mission	Vehicle	LV Type	Mission Type	LV Results
March 26	FLTSATCOM	AC-67	G/D-1AR	GTO	No Trial
<b>1989</b>					
September 25	FLTSATCOM	AC-68	G/D-1AR	GTO	Success
<b>1990</b>					
July 25	CRRES	AC-69	Atlas I	Elliptical	Success
<b>1991</b>					
April 18	BS-3H	AC-70	Atlas I	GTO	Failure
December 7	EUTELSAT II	AC-102	Atlas II	Supersynchronous	Success
<b>1992</b>					
February 10	DSCS III B14	AC-101	Atlas II	GTO	Success
March 13	Galaxy V	AC-72	Atlas I	GTO	Success
June 10	INTELSAT-K	AC-105	Atlas IIA	GTO	Success
July 2	DSCS III B12	AC-103	Atlas II	GTO	Success
August 22	Galaxy I-R	AC-71	Atlas I	GTO	Failure
<b>1993</b>					
March 25	UHF F/O F1	AC-74	Atlas I	Subsynchronous	Anomaly
July 19	DSCS III B9	AC-104	Atlas II	GTO	Success
September 3	UHF F/O F2	AC-75	Atlas I	Subsynchronous	Success
November 28	DSCS III B10	AC-106	Atlas II	GTO	Success
December 15	Telstar 401	AC-108	Atlas IIAS	GTO	Success
<b>1994</b>					
April 13	GOES I	AC-73	Atlas I	Supersynchronous	Success
June 24	UHF F/O F3	AC-76	Atlas I	Subsynchronous	Success
August 3	DirectTV D2	AC-107	Atlas IIA	Supersynchronous	Success
October 6	INTELSAT 703	AC-111	Atlas IIAS	Supersynchronous	Success
November 29	Orion F1	AC-110	Atlas IIA	Supersynchronous	Success
<b>1995</b>					
January 10	INTELSAT 704	AC-113	Atlas IIAS	Supersynchronous	Success
January 28	EHF F4	AC-112	Atlas II	Subsynchronous	Success
March 23	INTELSAT 705	AC-115	Atlas IIAS	Supersynchronous	Success
April 7	AMSC-1	AC-114	Atlas IIA	Supersynchronous	Success
May 23	GOES-J	AC-77	Atlas I	Supersynchronous	Success
May 31	EHF F5	AC-116	Atlas II	Subsynchronous	Success
July 31	DSCS III B7	AC-118	Atlas IIA	GTO	Success
August 28	JCSAT-3	AC-117	Atlas IIAS	Supersynchronous	Success
October 22	EHF F6	AC-119	Atlas II	Subsynchronous	Success
December 2	SOHO	AC-121	Atlas IIAS	Libration Point	Success
December 14	Galaxy III R	AC-120	Atlas IIA	Subsynchronous	Success
<b>1996</b>					
January 31	Palapa	AC-126	Atlas IIAS	Supersynchronous	Success
April 3	Inmarsat 1	AC-122	Atlas IIA	GTO	Success
April 30	SAX	AC-78	Atlas I	LEO	Success
July 25	EHF F7	AC-125	Atlas II	Subsynchronous	Success
September 8	GE-1	AC-123	Atlas IIA	Supersynchronous	Success
November 21	Hotbird	AC-124	Atlas IIA	GTO	Success
December 17	Inmarsat 3	AC-129	Atlas IIA	GTO	Success
<b>1997</b>					



Date	Mission	Vehicle	LV Type	Mission Type	LV Results
February 16	JCSAT 4	AC-127	Atlas IIAS	Supersynchronous	Success
March 8	DBS/TEMPO	AC-128	Atlas IIA	Subsynchronous	Success
April 25	GOES K	AC-79	Atlas I	Supersynchronous	Success
July 27	Superbird C	AC-133	Atlas IIAS	Supersynchronous	Success
September 4	GE-3	AC-146	Atlas IIAS	Supersynchronous	Success
October 5	Echostar III	AC-135	Atlas IIAS	GTO	Success
October 24	DSCS III	AC-131	Atlas IIA	Subsynchronous	Success
December 8	Galaxy 8i	AC-149	Atlas IIAS	Supersynchronous	Success
<b>1998</b>					
January 29	Capricorn MLV-7	AC-109	Atlas IIA	GTO	Success
February 27	INTELSAT 806	AC-151	Atlas IIAS	GTO	Success
March 16	UHF-FO F8	AC-132	Atlas II	Subsynchronous	Success
June 18	INTELSAT 805	AC-153	Atlas IIAS	GTO	Success
October 9	HotBird 5	AC-134	Atlas IIA	GTO	Success
October 20	UHF-FO F9	AC-130	Atlas IIA	Subsynchronous	Success
<b>1999</b>					
February 15	JCSAT-6	AC-152	Atlas IIAS	Supersynchronous	Success
April 12	Eutelsat W3	AC-154	Atlas IIAS	Supersynchronous	Success
September 23	EchoStar V	AC-155	Atlas IIAS	Supersynchronous	Success
November 22	UHF F/O F10	AC-136	Atlas IIA	Subsynchronous	Success
December 18	EOS Terra	AC-141	Atlas IIAS	LEO/Sunsynchronous	Success
<b>2000</b>					
January 20	MLV-8 DSCS III	AC-138	Atlas IIA	GTO	Success
February 3	Hispasat-1C	AC-158	Atlas IIAS	Supersynchronous	Success
May 3	GOES-L	AC-137	Atlas IIA	Subsynchronous	Success
May 24	Eutelsat W4	AC-201	Atlas IIIA	Supersynchronous	Success
June 30	TDRS-H	AC-139	Atlas IIA	Subsynchronous	Success
July 14	EchoStar VI	AC-161	Atlas IIAS	Supersynchronous	Success
October 19	MLV-9 DSCS B-11	AC-140	Atlas IIA	GTO	Success
December 5	MLV-11	AC-157	Atlas IIAS	GTO	Success
<b>2001</b>					
June 19	ICO-F2	AC-156	Atlas IIAS	MEO	Success
July 23	GOES-M	AC-142	Atlas IIA	Subsynchronous	Success
September 8	MLV-10	AC-160	Atlas IIAS	LEO	Success
October 10	MLV-12	AC-162	Atlas IIAS	GTO	Success
<b>2002</b>					
February 21	EchoStar VII	AC-204	Atlas IIIB	Supersynchronous	Success
March 8	TDRS-I	AC-143	Atlas IIA	Subsynchronous	Success
August 21	HotBird 6	AV-001	Atlas V 401	Supersynchronous	Success
September 8	HispaSat-1D	AC-159	Atlas IIAS	Subsynchronous	Success
December 4	TDRS-J	AC-144	Atlas IIA	Subsynchronous	Success
<b>2003</b>					
April 11	AsiaSat 4	AC-205	Atlas IIIB	Supersynchronous	Success
May 13	Hellas-Sat	AV-002	Atlas V 401	Supersynchronous	Success
July 17	Rainbow 1	AV-003	Atlas V 521	GTO	Success
December 2	MLV-14	AC-164	Atlas IIAS	LEO	Success
December 17	UHF-F11	AC-203	Atlas IIIB	GTO	Success

<b>Date</b>	<b>Mission</b>	<b>Vehicle</b>	<b>LV Type</b>	<b>Mission Type</b>	<b>LV Results</b>
<b>2004</b>					
February 5	AMC-10	AC-165	Atlas IIAS	GTO	Success
March 13	MBSat	AC-202	Atlas IIIA	GTO	Success
April 15	Superbird 6	AC-163	Atlas IIAS	Supersynchronous	Success
May 19	AMC-11	AC-166	Atlas IIAS	GTO	Success
August 31	L-1	AC-167	Atlas IIAS	LEO	Success
December 17	AMC-16	AV-005	Atlas V 521	Supersynchronous	Success
<b>2005</b>					
February 13	MLV-15	AC-206	Atlas IIIB	Molniya	Success
March 11	Inmarsat 4-F1	AV-004	Atlas V 431	Supersynchronous	Success
August 12	Mars Reconnaissance Orbiter	AV-007	Atlas V 401	Interplanetary	Success
<b>2006</b>					
January 19	New Horizons	AV-010	Atlas V 551	Interplanetary	Success
April 20	Astra 1 KR	AV-008	Atlas V 411	Subsynchronous	Success
<b>2007</b>					
March 8	STP-1	AV-013	Atlas V 401	LEO	Success
June 15	NROL-30	AV-009	Atlas V 401	Classified	Success
October 10	WGS SV-1	AV-011	Atlas V 421	Subsynchronous	Success
December 10	NROL-24	AV-015	Atlas V 401	Classified	Success
<b>2008</b>					
March 13	NROL-28	AV-006	Atlas V 411	Classified	Success
April 14	ICO G1	AV-014	Atlas V 421	GTO	Success
<b>2009</b>					
April 3	WGS-2	AV-016	Atlas V 421	Supersynchronous	Success
June 18	LRO/LCROSS	AV-020	Atlas V 401	Lunar Transfer	Success
September 8	PAN	AV-014	Atlas V 401	Classified	Success
October 18	DMSP-18	AV-017	Atlas V 401	LEO/Sunsynchronous	Success
November 23	Intelsat-14	AV-024	Atlas V 431	Supersynchronous	Success
<b>2010</b>					
February 11	SDO	AV-021	Atlas V 401	GTO	Success

## APPENDIX B — MISSION SUCCESS, QUALITY ASSURANCE, AND PERFECT PRODUCT DELIVERY

### B.1 QUALITY MANAGEMENT SYSTEM

United Launch Alliance (ULA) organizations utilize a process-management approach to add value to their products and services. With this approach, a variety of process owners and people working within a process use objective measures to understand, evaluate, sustain, and improve the performance of their processes. ULA tracks progress toward improvement through established process-improvement goals that support both the process and the customer's expectations, while tracking progress toward these goals.

ULA seeks to understand, anticipate, and be responsive to customer requirements and expectations. ULA establishes processes to ensure the resulting products and services comply with customer requirements and that customer satisfaction has been achieved.

ULA operates an AS9100 (Quality Management Systems-Aerospace-Requirements) registered quality management system. ULA is internationally accredited through National Quality Assurance (NQA) under registration number 12317. The registration was conferred in October 2004, and includes ULA's Centennial, CO; Pueblo, CO; Decatur, AL; San Diego, CA; Harlingen, TX; Cape Canaveral Air Force Station, FL; and Vandenberg Air Force Base, CA facilities. The change scope of the registration includes the acquisition, final assembly, preparation, test, payload integration and launch of space system launch vehicles. This includes the design, development, installation, test and operation of associated launch facilities and ground support equipment.

NQA annually revalidates adherence to the AS9100 quality standard as an independent, third party registrar. In addition, the U.S. Government's Defense Contract Management Agency (DCMA) monitors AS9100 compliance onsite and maintains insight into ULA processes.

AS9100 is executed through ULA's internal command media, which is described in the *Quality Management System Manual (QS-100)* and CPS-033, ULA command media. AS9100 is a comprehensive quality management system that provides a framework of operating requirements.

ULA maintains its AS9100 registration to the latest released version of the standard. ULA's registration also certifies compliance to ISO 9001:2008.

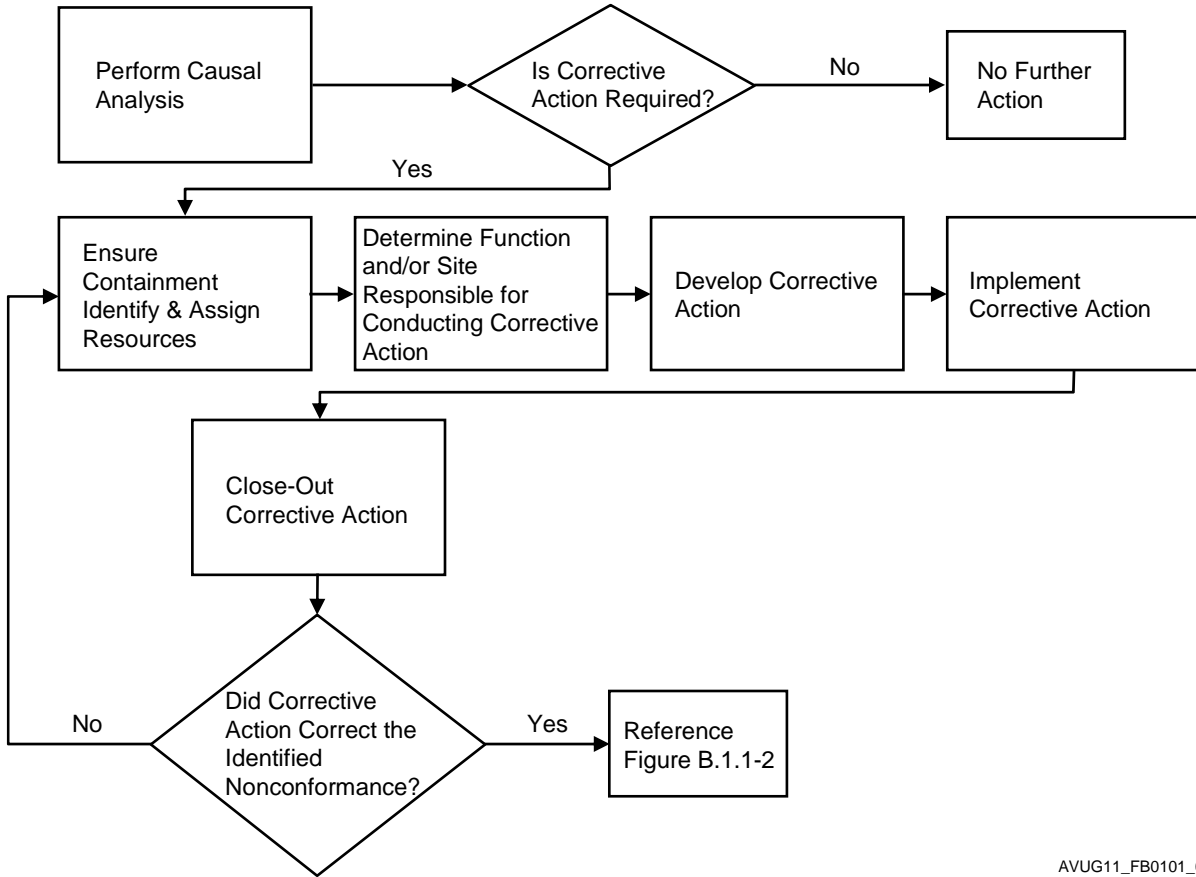
#### B.1.1 Quality Assurance

Quality Assurance (QA) ensures the quality of products and processes to achieve maximum effectiveness and continued stakeholder confidence.

ULA ensures quality through physical examination, measurement, test, process monitoring, and/or other methods as required to determine and control the quality of all deliverable airborne and ground equipment products, software, and services. Independent verification includes mandatory inspection points; witness, monitor, and surveillance; statistical methods; data analysis; trending; sampling plans; work instruction, build, and test documentation review; associated data reviews; process control; assessments; acceptance tooling; and/or other techniques suited to the products or processes being verified. The following paragraphs define responsibilities.

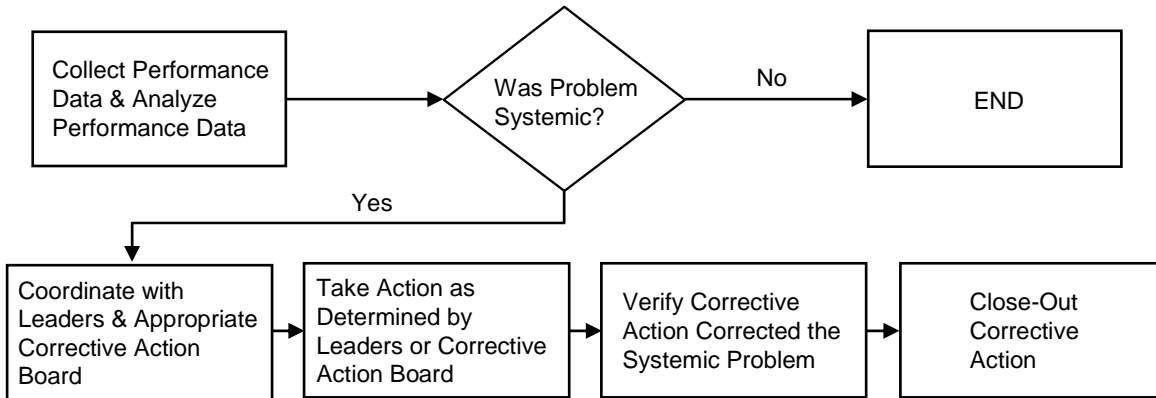
**Corrective/Preventive Action** — The corrective and preventive action process (Figures B.1.1-1 through -3) ensures visibility and resolution of anomalous conditions affecting or potentially affecting products, processes, or systems. This process encompasses customer concerns, internal activities, and supplier issues. The corrective and preventive action process ensures that ULA identifies and documents problems, determines and records root causes, identifies and reviews for appropriateness of corrective actions, and implements and verifies the effectiveness of corrective or preventive actions.

Figure B.1.1-1: Detailed Corrective Action Process



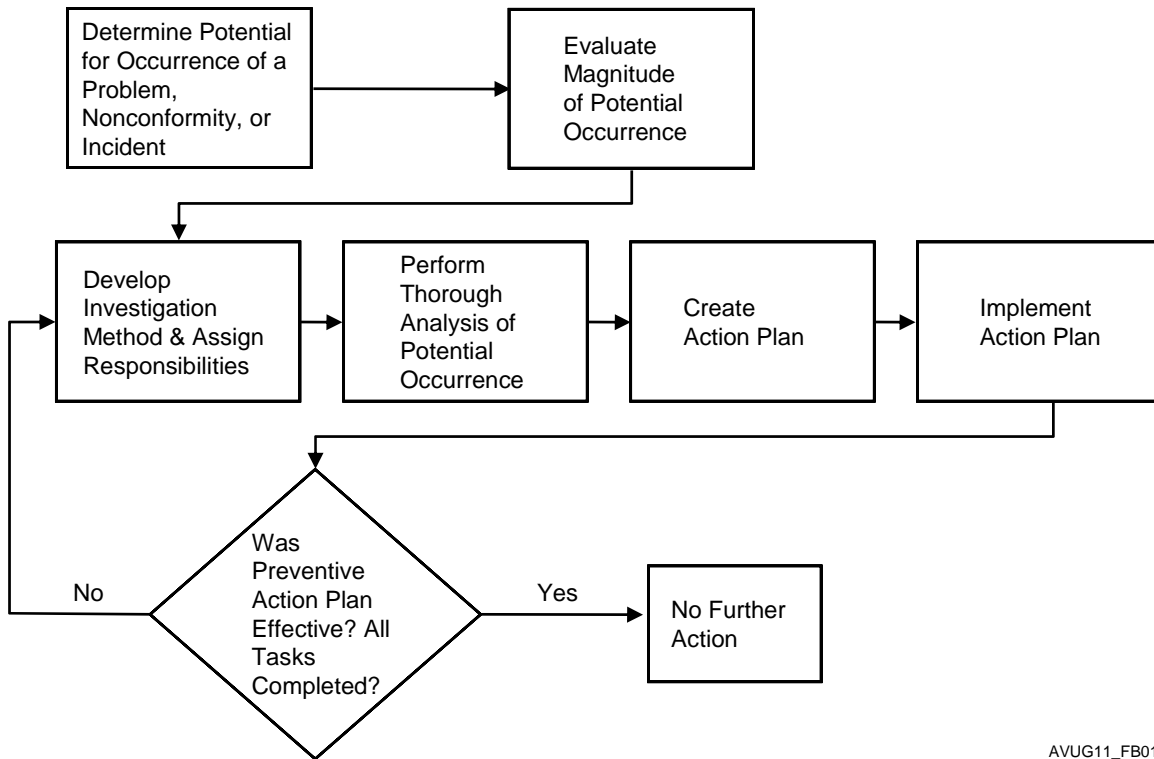
AVUG11\_FB0101\_01b

Figure B.1.1-2: Systemic Corrective Action Process



AVUG11\_FB0101\_02c

Figure B.1.1-3: Preventive Action Process



AVUG11\_FB0101\_03b

**Design Reviews** — QA participates at an appropriate level in conceptual, preliminary, critical, and drawing-level design reviews. The design review activity provides requirements flowdown, critical characteristics identification, acceptance strategy development, and method analysis. This ensures inspectability and acceptability of detailed drawings and specifications, and promotes producibility (Figure B.1.3-1).

**Parts, Materials, and Processes Control Board** — The Parts, Materials, and Processes (PMP) Control Board (PMPCB) provides the method for ensuring the use of proven parts, materials, and processes across the product line. The board is the primary channel of communication for the interchange of PMP information analyses. The PMPCB provides direction for procurement activities to support product line schedules. This includes direction to order parts, assign component selection priorities, and ensure mitigation of device lot failures.

**Change Control** — All engineering changes are managed, routed and approved by the Engineering Operational Systems and implemented by the Product Delivery Teams (PDTs), Production Operations, and Supplier Management. ULA presents all preliminary changes in a formal PDT meeting. This multidiscipline team reviews and coordinates the detailed scope of the change and provides inputs for scheduling, process planning, material planning, and configuration management. The PDTs provide status of each change through final engineering release and coordinate release with the product schedule and delivery requirements. Quality Assurance Engineering participates in this process, ensuring each change yields inspectable and acceptable products of known and controlled configuration.

**Work Instructions** — All work affecting quality is prescribed in documented instructions of a type appropriate to the circumstances. Work instructions (paper and/or electronic) encompass purchasing, handling, machining, assembling, fabricating, processing, inspecting, testing, modifying, installing, and any other treatment of product, facilities, standards, or equipment. ULA monitors preparation and maintenance of work instructions and manufacturing processes as a function of the quality program.

**Procurement Quality Assurance** — Procurement Quality Assurance (PQA) is a ULA functional organization that provides resources to enable product line execution across the ULA Enterprise. PQA is responsible for developing and deploying efficient and effective processes and systems as well as training and developing suppliers, PDTs and Site Functional Teams (SFTs) to execute flawlessly on product lines and reduce costs. ULA deploys PQA in two major organizational entities: Procurement Quality Assurance Representatives (PQARs) and Procurement Quality Engineers (PQEs). PQARs are geographically regionalized groups of Procurement Quality personnel that provide services to the ULA product lines. These services include quality management systems and special process surveys, process validation assessments, source inspection and surveillance, quality requirements review, supplier performance improvement, lean initiatives at supplier facilities, corrective action at suppliers and special tasks assigned by product lines. PQEs are responsible for but not limited to source selection, quality surveillance planning support, receiving inspection, supplier process improvement board, supplier escapements, supplier evaluation team (fault assignment accuracy) deviation letters and approvals, purchase order quality clause application, Procurement Corrective Action Board (P/CAB) and quality councils and summits.

**Acceptance Status** — Objective evidence of compliance to requirements of contract, specifications, configuration, and process control is maintained and is made available to hardware acceptance teams at all manufacturing and test facilities. Quality Assurance provides a positive system for identification of the inspection and acceptance status of products. This is accomplished by stamping, tags, routing cards, move tickets, build records, and/or other control devices. The overall product acceptance program is controlled by adherence to QS-100, ULA Quality Management System Manual, which provides direction for acceptance processes at Denver, Pueblo, Decatur, San Diego, Harlingen, Cape Canaveral Air Force Station (CCAFS), Vandenberg Air Force Base (VAFB), and at suppliers.

**Identification and Stamp Control** — Inspection, fabrication, workmanship (including physical or electronic stamps), signatures, acceptance, and status markings are controlled and traceable to the individuals performing those functions.

**Nonconforming Hardware** — When ULA initially finds a material to be nonconforming, it is examined by Preliminary Material Review (PMR) certified personnel. Assistance by inspection, manufacturing, and engineering personnel is often necessary to determine if the nonconformance can be eliminated through rework, scrapping, or by returning hardware to the supplier. If none of these criteria can be met, the material is referred to the Material Review Board (MRB) for disposition. QA ensures that all nonconforming material is identified and controlled to preclude its subsequent use in deliverable items without proper disposition. Quality Engineering chairs the MRB to determine appropriate disposition of nonconforming material. The board includes a representative from the Engineering organization, who is responsible for product design. Program Quality Assurance (QA) certifies and approves all MRB members.

**Evaluation of Suspect Hardware** — Hardware that may be affected by a potentially generic or systemic problem is controlled and dispositioned via the Suspect Product Evaluation (SPE) and/or Line Stock Check (LSC) processes. These processes utilize the nonconformance system to control suspect items until ULA verifies the condition and completes an appropriate disposition.

**Software Quality** — The Software Quality Program ensures software products (code and documentation) are compliant with program, corporate, and customer requirements. Specifically, the program provides the methods necessary to:

1. Ensure approved processes and procedures are followed in design, development, testing, configuration management and delivery of software products
2. Ensure requirements are clear, quantifiable, traceable, appropriately allocated, and testable
3. Ensure subcontracted software development according to approved processes and procedures

4. Ensure Software Action Request (SAR) tracking to closure and incorporating only approved anomalies into controlled baselines

The software development process builds quality into the software and documentation and maintains levels of quality throughout the life cycle of the software. This includes independent technical evaluations, software testing, documentation verification, and management reviews necessary to achieve this goal.

**Record Retention** — All quality records are retained as required by contract, ULA command media, and specific product line direction. ULA uses a secure QA data center as the central repository for quality-related component and vehicle data.

**Training and Certification** — The ULA Certification Board ensures accuracy and integrity for employee certifications in product development, test, and operations. The board ensures that personnel requiring special skills in fabrication, handling, test, maintenance, operations, and inspection of products are trained and are qualified to ensure capability to perform critical functions. Board responsibilities include process oversight for certification of individuals and crews at all ULA sites.

**Metrics** — ULA maintains metrics to provide a continuous assessment of product line performance, to control and/or reduce product line costs, to ensure continued mission success, and to drive the enterprise toward improvement. Examples of metrics maintained are:

1. Escapements
2. Recurring Nonconformances
3. Supplier Liability
4. Foreign Object Incidents
5. Back log and Aging of Nonconformance Documents
6. Open Items/Clean Vehicle
7. Training — Certification
8. Mishaps/Near Misses
9. Customer Satisfaction and Feedback
10. Software Quality Performance Metrics
11. System Safety Metrics
12. Corrective Action Board Maturity

ULA reviews QA metrics (Quality, System Safety, and Software Quality) each month at the Quality Assurance and Systems Safety Operating Review (QASSOR).

**Calibration** — ULA maintains and documents a calibration system to ensure that supplies and services presented for acceptance conform with prescribed technical requirements. This system applies to adequacy of standards, environmental control, intervals of calibration, procedures, out-of-tolerance evaluation, statuses, sources, applications and records, control of subcontractor calibrations, and storage and handling.

**Acceptance Tooling** — When production jigs, fixtures, tooling masters, templates, patterns, test software, and other devices are used as a method for acceptance, they are tested for accuracy before release and at periodic intervals to ensure that their accuracies meet or exceed product requirements.

### **B.1.2 Atlas Launch Operations Quality Assurance**

Atlas Launch Operations QA supports launch sites during launch vehicle processing, ground systems maintenance and installations, and checkout of modifications.

QA is the focal point for coordination of facility issues with VAFB and CCAFS QA personnel. In cases where products are to be shipped with open engineering or open work, QA provides the necessary coordination with site personnel. This single-point of contact between Denver and the sites ensures clear communication and provides a filter to minimize open items.

All launch site operations are an extension of factory operations and are covered by the same requirements for reporting, control, and problem resolution.

#### **B.1.2.1 Payload Operations**

Payload Operations coordinates and implements integrated spacecraft and launch vehicle tasks. The system engineer is responsible for integration activities and ensuring compliance to specifications and customer direction.

For launch vehicle activities, Payload Operations responds as the customer's agent in coordinating integrated activities and providing support as requested by the customer. ULA personnel at the launch site participate in the total quality system process (oversight, engineering, and inspection) during spacecraft integration at commercial and government processing facilities. This effort includes mating to payload adapters, encapsulation, radio frequency checkout, integration testing, and transportation to the launch pad.

#### **B.1.2.2 Safety Operations**

Safety Operations include system safety engineering efforts and launch site operations safety support. To ensure personnel safety, our Safety Operations Group provides onsite support from hardware receipt through launch. Operational support includes consultation/coordination of industrial, material handling, fire protection, and environmental/chemical safety requirements; enforcement of ULA requirements, Federal Aviation Administration (FAA) and U.S. Department of Transportation (DOT) policies/requirements as well as Range Safety policy; and oversight of selected activities.

System Safety reviews potential spacecraft design hazards/risks, assesses launch vehicle/spacecraft interfaces, and evaluates mission-specific ground processing operations to identify hazard risks and develop the appropriate hazard controls. System Safety coordinates ULA technical issues with the 45<sup>th</sup>/30<sup>th</sup> Space Wing and timely completion of the Range Safety review and approval process (refer to Section 4.3).

### **B.1.3 Mission Success — Independent Oversight**

The Mission Success organization provides an evaluation for product line and ULA management, independent from Engineering and QA, to ensure all potential mission impacts at ULA and/or suppliers are resolved prior to launch. ULA accomplishes this through its participation in product line activities, such as tabletops and reviews, and through the reporting of all functional failures to the Mission Success organization. Mission Success Engineers (MSE) coordinate technical evaluations with appropriate subject-matter experts to establish mission impact. ULA presents significant technical or design issues and risks related to failures to either the Anomaly Review Board (ARB) or the Vice President Review Board (VPRB), dependent on the severity and/or level of risk acceptance for the problem, to ensure complete analysis and effective remedial and corrective action to mitigate mission impacts. The ARB, chaired by either the (PDT) Chief Engineer or the Product Line Chief Engineer dependent upon the level of risk/impact to the Product

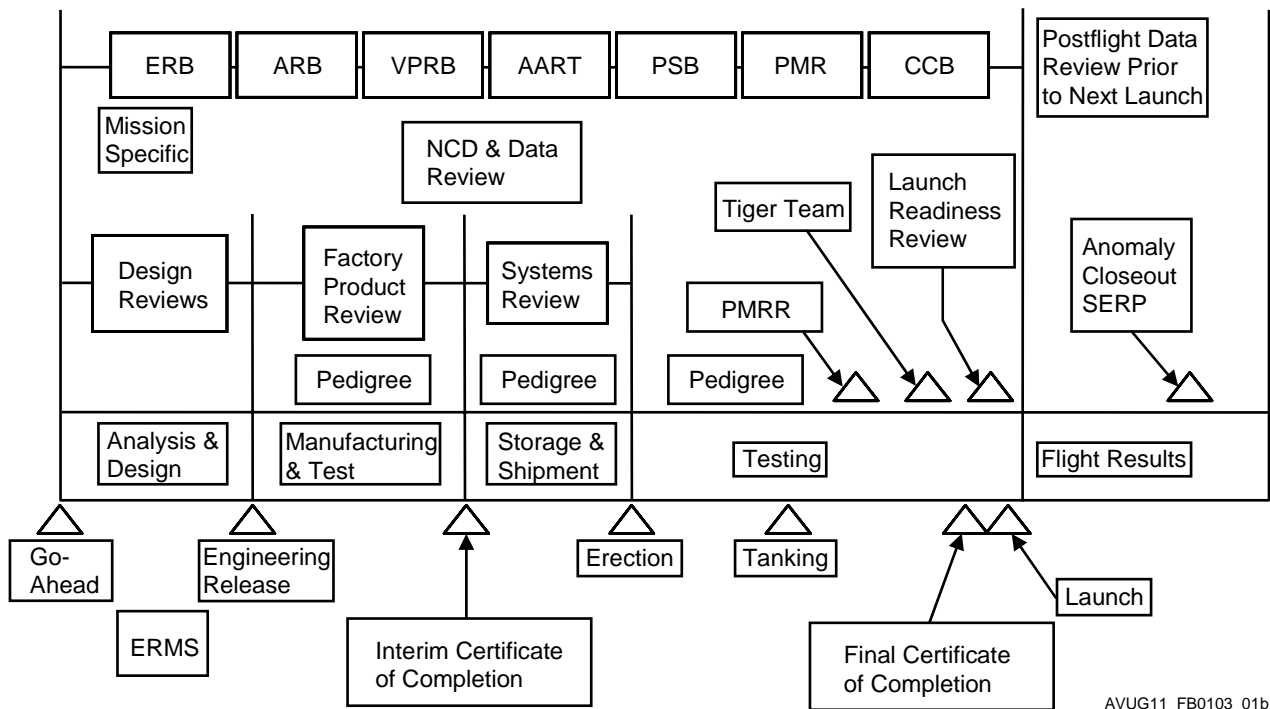


Line, operates with Mission Success as a quorum member. The VPRB, chaired by the Product Line Vice President, operates with Mission Success as a quorum member and reviews items that may have significant impact to the Product Line or carry elevated levels of mission success risk. The ARB and VPRB include technical experts that ensure the complete investigation and resolution of all hardware concerns potentially affecting mission success. Mission Success ensures all applicable flight constraints are resolved before launch.

**Alerts** — The Government-Industry Data Exchange Program (GIDEP) review process includes evaluating GIDEP alerts for impacts to hardware. All known alerts will be reviewed for impacts before each flight.

**Reviews** — The Mission Success organization participates in engineering, factory, data, and readiness reviews to support program management in determining hardware flight worthiness and readiness. ULA assigns an MSE to each mission to ensure that vehicle noncompliance issues are appropriately resolved. The MSE also coordinates vehicle certificates of completion and flight constraint closeouts. The MSE follows the assigned vehicle throughout the production and launch sequence and reports on vehicle readiness in a series of program reviews. Figure B.1.3-1 is a flow of the acceptance process, including progressive reviews and acceptance throughout design, production, test, launch site operations, and the post flight review process.

Figure B.1.3-1: Mission Success Acceptance Process



AVUG11\_FB0103\_01b

## B.2 PERFECT PRODUCT DELIVERY



Perfect Product Delivery is our relentless pursuit of perfection to achieve excellence in everything we do. It applies our passion for mission success to continuously improve every process and product, to completely meet the needs of every customer; and it inspires and empowers all employees to dedicate their innovative talents to deliver program success and develop a world-class working environment.

Another way to clarify these ideas is to recognize that Perfect Product Delivery is about optimizing the ULA value stream through the institutionalization of continuous improvement, and that is always driven by customer value. Through Perfect Product Delivery, ULA seeks to achieve a state where all products that come from the value stream meet or exceed all customer expectations, and this will be accomplished by the operation of reliable and efficient processes.

Because Perfect Product Delivery is always customer focused, ULA wants all customers to be active participants in our journey at all phases of execution.

### B.2.1 Starting with the Customer — the Right Metrics and the Right Behaviors

Our basic approach to making improvements at ULA is through the implementation of the key customer driven metrics. They are metrics that measure the performance of the value stream at the organizational interfaces. ULA intends these metrics to be a very limited number of critically meaningful measures about what will be improved. Imperative to the success of this is that the entire Organization (at all levels) must proactively seek out their customers and suppliers and then decide from that interaction what is most important to be improved. This is the quantitative improvement element of Perfect Product Delivery.

In conjunction with the quantitative element noted above, ULA also employs a qualitative element based on focusing on the improvement of the key behaviors. These two improvement elements are complementary and work together to help achieve excellence for the enterprise. In this qualitative element, ULA strives to understand and then improve the following behavioral attributes: customer focused, supplier enabling, reliability, efficiency, flexibility, and continuous improvement.

ULA strengthens key behaviors along the value stream using a maturity model. This model is designed to better impart these behavioral attributes into ULA's people, processes, and products. This is done so that the best cultural environment can be produced that will bring forth the results of the Perfect Product Delivery ethic.

These key behavioral attributes are critical for the sustainment and growth of improvement. To help all areas of ULA become proficient with these behaviors, ULA has established a 2-day Perfect Product Delivery Assessment called the Vision of Excellence (VoE). The VoE assessment provides critical feedback to an

organization so it can see and calibrate its own action plans to make needed adjustments and improvements. The VoE advances the qualities of the way ULA's people think → behave → act → perform.

### **B.2.2 Making Change Happen — Improving the Business**

Once an organization understands where the areas of improvement are, the next component of the Perfect Product Delivery process is to apply the best continuous improvement tools to enable positive change. Achievement of success relies on a distributed network of Continuous Improvement Practitioner Green Belts (Level I) and Black Belts (Level II) to apply Lean and Six Sigma skills, methods, and tools to identify, define, and create more effective and efficient processes and products for our customers. Lean and Six Sigma are the means to the end, which is always Perfect Product Delivery.

Systemic engagement at all levels of the organization and at all areas of the value stream is the all-important key to achieving success. To ensure the success of this framework, ULA creates an orchestrated structure of engagements that bring people together in collaborative forums to enable the necessary changes to become reality. This engagement extends from the Chief Executive Officer (CEO) and Chief Operation Officer (COO) and all ULA executives, to all front-line technicians who produce and launch the hardware, to all suppliers, up to ULA's Government customers. All stakeholders have an essential role to help to create ULA's success with Perfect Product Delivery through Engagement.

#### **Mission Success + Program Success = Stakeholder Success**

In a Perfect Product Delivery environment, not only will ULA meet the industry's most complex technical challenges each and every time with mission success, it will do it in a manner that will also impart program success to all of its stakeholders. Another way to perceive this is that ULA seeks to provide flawless launch services (one mission at a time) in a structured manner that also runs a healthy business, bringing significant value to all stakeholders. For Perfect Product Delivery, mission success and program success are requisite expectations as equivalent deliverables. This is the single ethic of Perfect Product Delivery and it is our passion in our drive for excellence.

Page Intentionally Left Blank

**GLOSSARY**

3-D	Three Dimensional
$3\sigma$	3-Sigma
$\Delta V$	Delta Velocity
$\omega\rho$	Argument of Perigee
A	Ampere(s)
Å	Angstrom(s)
ABC	Aft Bulkhead Carrier
ac	Alternating Current
A/C	Air Conditioning
ADDJUST	Automatic Determination and Dissemination of Just-Updated Steering Terms
ADMS	Automated Data Monitoring System
ADS	Automatic Destruct System
ADU	Automatic Destruct Unit
AFM	Air Force Manual
AFR	Air Force Regulation
AFSCF	Air Force Satellite Control Facility
AFSCN	Air Force Satellite Control Network
AFSPCMAN	Air Force Space Command Control Manual
AGE	Aerospace Ground Equipment
AHU	Air Handling Unit
Al	Aluminum
Alt	Altitude
AMPG	Atlas Mission Planner's Guide
ANSI	American National Standards Institute
AP	Auxiliary Payload
APL	Auxiliary Payload
ARB	Anomaly Review Board
ARCU	Atlas Remote Control Unit
Arg	Argument
AS	Atlas Station
ASA	Aft Stub Adapter
ASO	Astrotech Space Operations
ASOC	Atlas V Spaceflight Operations Center
ASQC	American Society for Quality Control
ATP	Authority To Proceed
ATS	Aft Transition Structure
AVE	Aerospace Vehicle Equipment
AVG	Average
AVUG	Atlas V User's Guide
AWG	American Wire Gauge
Batt	Battery
BECO	Booster Engine Cutoff
BETO	Booster Engine Thrust Oscillation
Bldg	Building
BM	Base Module

BOS	Bottom of Steel
BPC	Back Pressure Control
BPJ	Booster Package Jettison
BPS	Booster Pressurization System
BPS	Booster Propulsion System
BPSK	Binary Phase-Shift Keying
BRCU	Booster Remote Control Unit
BSI	British Standards Institute
Btu	British thermal unit(s)
°C	Degrees Celsius
C3	Earth Escape Velocity
CAD	Computer Aided Design
CAP	C-Adapter Platform
CBOD	Clampband Opening Device
CCAFS	Cape Canaveral Air Force Station
CCAM	Collision and Contamination Avoidance Maneuver
CCB	Common Core Booster™
CCB	Change Control Board
CCLS	Computer Controlled Launch Set
CCTV	Closed Circuit Television
CDR	Critical Design Review
CDRL	Contract Data Requirements List
CEO	Chief Executive Officer
CFA	Centaur Forward Adapter
CFLR	Centaur Forward Load Reactor
cfm	cubic feet per minute
cg	center of gravity
CIB	Change Integration Board
C-ISA	Centaur Interstage Adapter
CLA	Coupled Loads Analysis
CLE	Centaur Longitudinal Event
cm	centimeter(s)
Cmd	Command
C/O	Checkout
Coax	Coaxial
COLA	Collision Avoidance
Comm	Communications
ConOps	Concept of Operations
COO	Chief Operating Officer
COPV	Composite Overwrapped Pressure Vessel
CPM	Common Payload Module
CPO	Customer Program Office
CRCU	Centaur Remote Control Unit
CRES	Corrosion Resistant Steel
CS	Centaur Station
CSF	Customer Support Facility
CSS	Centaur Sun Shield
CT	Command Transmitter

CVAP	Centaur Vent and Pressurization
CVAPS	Centaur Vent and Pressurization System
CW	Continuous Wave
DAS	Data Acquisition System
dB	decibel(s)
dBi	decibels with respect to an isotropic radiator
dBm	decibels above 1 milliwatt
dc	Direct Current
DCMA	Defense Contract Management Agency
DDSI	Dual Direct Spark Ignition
DE	Dual Engine
DEC	Dual Engine Centaur
Deg	Degree
Dia	Diameter
DLF	Design Load Factor
DoD	Department of Defense
DOF	Degrees of Freedom
DOP	Diocetyl Phthalate
DOT	Department of Transportation
DPC	Dual Payload Carrier
DPC-S	Dual Payload Carrier - Short
DPF	Defense Satellite Communications System (DSCS) Processing Facility
DPM	Director Program Management
DSCS	Defense Satellite Communications System
DSI	Direct Spark Ignition
DSS	Dual Spacecraft System
DSN	Deep Space Network
DV	Delta Velocity
E	East
E	Electric
ECS	Environmental Control System
ECU	Electronic Control Unit
EED	Electroexplosive Device
EELV	Evolved Expendable Launch Vehicle
e.g.	Exempli Gratia (Latin for "for example")
EHA	Electrical Hydraulic Actuator
EL	Elevation
EM	Electromagnetic
EMA	Electromechanical Actuator
EMC	Electromagnetic Compatibility
EMI	Electromagnetic Interference
EMK	Extended Mission Kit
EOC	Engineering Operations Center
EPA	Environmental Protection Agency
EPF	Extended Payload Fairing
EPIC	Electronic Portable Information Collection
ER	Eastern Range

ERB	Engineering Review Board
ERR	Eastern Range Regulation
ESA	Engineering Support Area
ESD	ElectroStatic Discharge
ESMCR	Eastern Space and Missiles Control Regulation
ESPA	EELV Secondary Payload Adapter
ET	External Tank
EVCF	Eastern Vehicle Checkout Facility
EWR	Eastern/Western Range
°F	Degrees Fahrenheit
FAA	Federal Aviation Administration
FAB	Final Assembly Building
FAP	Fairing Acoustic Protection
FCA	Flow Control Assembly
FCDC	Flexible Confined Detonating Cord
FCS	Flight Control Subsystem
FFDP	Final Flight Data Package
FFPA	Final Flight Plan Approval
FHB	Flight Hardware Building
FJA	Frangible Joint Assembly
Flt	Flight
FM	Flight Model
FM	Frequency Modulation
FMH	Free Molecular Heating
FO	Fiber Optic
FO	Final Orbit
FOTS	Fiber Optics Transmission System
FPA	Flight Plan Approval
FPR	Flight Performance Reserve
fps	feet per second
FS	Factor of Safety
ft	foot (feet)
ft <sup>2</sup>	square feet
FTINU	Fault Tolerant Inertial Navigation Unit
FTS	Flight Termination System
Fwd	Forward
g	gravity
G	Giga
G&C	Guidance and Control
GC <sup>3</sup>	Ground, Command, Control, and Communication
GCS	Guidance Commanded Shutdown
GHe	Gaseous Helium
GIDEP	Government-Industry Data Exchange Program
GMM	Geometric Mathematical Model
GN <sub>2</sub>	Gaseous Nitrogen
G&N	Guidance and Navigation
GN&C	Guidance, Navigation, and Control



Gnd	Ground
GORR	Ground Operations Readiness Review
GOWG	Ground Operations Working Group
GPS	Global Positioning System
GSE	Ground Support Equipment
GSFC	Goddard Space Flight Center
GSO	Geosynchronous Orbit
GSTDN	Ground Satellite Tracking and Data Network
GTO	Geosynchronous Transfer Orbit
GTV	Ground Transport Vehicle
H	Height
Ha	Height of Apogee
He	Helium
HEPA	High Efficiency Particulate Air
HLV	Heavy Lift Vehicle
hp	horsepower
Hp	Height of Perigee
HPF	Hazardous Processing Facility
hr	hour(s)
HTPB	Hydroxy-Terminated PolyButadiene (solid propellant)
HVAC	Humidity, Ventilation, and Air Conditioning
Hz	hertz
I	Inclination
ICA	Interface Compatibility Analysis
ICBM	Intercontinental Ballistic Missile
ICD	Interface Control Document
i.e.	Id Est (Latin for "that is")
I/F	Interface
IFD	In-Flight Disconnect
IFR	Inflight Retargeting
IGES	Initial Graphics Exchange Specification
IIP	Instantaneous Impact Point
IPT	Integrated Product Team
ILC	Initial Launch Capability
IMS	Inertial Measurement System
in.	inch(es)
INU	Inertial Navigation Unit
IOC	Initial Operational Capability
IPC	Integrated Payload Carrier
IPF	Integrated Processing Facility
IRD	Interface Requirements Document
ISA	Interstage Adapter
ISO	International Standards Organization
I <sub>SP</sub>	Specific Impulse
ISP	Specific Impulse
IST	Integrated System Test
ITA	Integrated Thermal Analysis

ITAR	International Traffic in Arms Regulations
ITP	Integrated Test Plan
ITPAC	In-Transport Payload Air Conditioning
JPL	Jet Propulsion Laboratory
JSpOC	Joint Space Operations Center
k	Convolutional constraint length
k	Kilo (Thousand)
KAMAG	Karlsdorfer Maschinenbaugesellschaft
kbps	kilo (1000) bits per second
kg	kilogram(s)
klb	kilopound(s)
km	kilometer(s)
kN	kilonewton(s)
KPa	kilopascal(s)
KSC	Kennedy Space Center
kVA	kilovolt-ampere(s)
kV/m	kilovolt(s) per meter
LAAFB	Los Angeles Air Force Base
LAE	Liquid Apogee Engine
LAN	Local Area Network
lb	pound(s)
lbf	pounds-force
LC	Launch Complex
LC	Launch Conductor
LCC	Launch Control Center
LD	Launch Director
LDA	Launch Decision Authority
LEO	Low Earth Orbit
LH <sub>2</sub>	Liquid Hydrogen
LKEI	Khrunichev-Energia International Incorporated
L.L.C.	Limited Liability Company
LMC	Lockheed Martin Corporation
LMCLS	Lockheed Martin Commercial Launch Services
LMD	Lockheed Martin Mission Director
LMSSC	Lockheed Martin Space Systems Company
LN <sub>2</sub>	Liquid Nitrogen
LO <sub>2</sub>	Liquid Oxygen
LOB	Launch Operations Building
LOC	Launch Operations Center
LPF	Large Payload Fairing
LPM	Lower Payload Module
LR	Load Ratio
LRB	Liquid Rocket Booster
LRR	Launch Readiness Review
LSB	Launch Services Building
LSC	Line Stock Check

LSIC	Launch System Integration Contractor
LSP	Launch Service Program
LSPSS	Low Shock Payload Separation System
LV	Launch Vehicle
LVA	Launch Vehicle Adapter
LVCE	Launch Vehicle Chief Engineer
LVMP	Launch Vehicle Mission Peculiar
LVRT	Launch Vehicle Readiness Test
m	meter(s)
m	milli
m <sup>2</sup>	square meter(s)
M	Million(s)
MAPS	Mission Air Purge System
MATL	Material
Max	Maximum
MCR	Minimum Call Rate
MDC	Mission Director's Center
MDU	Master Data Unit
MECO	Main Engine Cutoff
MEOP	Maximum Expected Operating Pressure
MES	Main Engine Start
MHz	MegaHertz
MILA	Merritt Island Launch Area
Min	Minimum
MIT	Mission Integration Team
MLI	Multi-Layer Insulation
MLP	Mobile Launch Platform
MOC	Mission Operations Center
MON	Mixed Oxides of Nitrogen
MP	Mission Peculiar
MPDR	Mission Peculiar Design Review
mps	meters per second
MR	Mixture Ratio
MRB	Material Review Board
MRS	Minimum Residual Shutdown
MS	Microsoft
m/s	meters per second
MSE	Mission Success Engineer
MSPSP	Missile System Prelaunch Safety Package
MSR	Mission Support Room
MST	Mobile Service Tower
mT	Metric Ton, 1000 kg
MTU	Main Turbopump Unit
MVB	Main Vehicle Battery
N	Newton(s)
NASA	National Aeronautics and Space Administration
NC	Not Controlled

NDR	Negative Differential Resistance
N <sub>2</sub> H <sub>4</sub>	Hydrazine
NIOSH	National Institute for Occupational Safety and Health
nmi	nautical mile(s)
NPRD	Non-electronic Parts Reliability Database
NPS	Naval Post-Graduate School
NPSCul	Naval Post-Graduate School CubeSat Launcher
NPSVI	Non-Public Space Vehicle Information
NQA	National Quality Assurance
NRO	National Reconnaissance Office
NRZ-L	Nonreturn-to-Zero Level
NRZ-M	Nonreturn-to-Zero Mark
NSO	No Signal Observed
NVR	Nonvolatile Residue
OASPL	Overall Sound Pressure Level
Obs	obscuration
OCC	Operations Communication Center
OD	Outer Diameter
OIS	Operational Intercommunications System
OIS	Orbit Insertion Stage
OML	On-orbit Maneuver Lifetime
Op	Operation(s)
ORBITS	Online Rocket Build Inspection and Test System
ORCA	Ordnance Remote Control Assembly
ORD	Operations Requirements Document
OSHA	Occupational Safety and Health Administration
OSL	Office of Space Launch
OTM	Output Transformation Matrices
OVS	Operational Voice System
Pa	Pascals
PA	Product Assurance
PAFB	Patrick Air Force Base
PAOR	Product Assurance Operations Review
PB	Preburner
PCA	Payload Control Area
P/CAB	Procurement Corrective Action Board
PCM	Pulse Code Modulation
PDR	Preliminary Design Review
PDSM	Product Delivery System Manual
PDT	Product Delivery Team
PEB	Payload Equipment Building
PFDP	Preliminary Flight Data Package
PFJ	Payload Fairing Jettison
PFM	Protoflight Model
PFPA	Preliminary Flight Plan Approval
PHSF	Payload Hazardous Servicing Facility
PIU	Pyroinhibit Unit

Pk	Peak
PL	Places
P/L	Payload
PLA	Payload Adapter
PLCP	Propellant Leak Contingency Plan
PLF	Payload Fairing
PLIS	Propellant-Level Indicating System
PLRR	President's Launch Readiness Review
PM	Propellant Margin
PMP	Parts, Materials, and Processes
PMPCB	Parts, Materials, and Processes Control Board
PMR	Preliminary Material Review
p/n	Part Number
PO	Park Orbit
PPD	Perfect Product Delivery
PPF	Payload Processing Facility
PPOD	Poly Picosatellite Orbital Deployer
Pps	pulse per second
PQA	Procurement Quality Assurance
PQAR	Procurement Quality Assurance Representative
PQE	Procurement Quality Engineer
PRD	Program Requirements Document
Prelim	Preliminary
Pro-E	Pro-Engineer
psf	pounds per square foot
psi	pounds per square inch
psig	pounds per square inch, gage
PSM	Parameter Signal Measurement
PSR	Payload Separation Ring
PSS	Payload Separation System
PST	Product Support Team
PSW	Payload Systems Weight
PTC	Parametric Technology Corporation
PTC	Payload Test Conductor
PTF	Pressure Test Facility
PU	Propellant Utilization
PVA	Perigee Velocity Augmentation
PVan	Payload Van
PVC	Polyvinyl Chloride
P&W	Pratt & Whitney
Pwr	Power
PYC	Pyrotechnic Control
Q	Dynamic Pressure
Q	Resonant Amplification Factor
QA	Quality Assurance
QASSOR	Quality Assurance and Systems Safety Operating Review
QPSK	Quadrature Phase-Shift Keying
Qual	Qualification

R	Radius
RAAN	Right Ascension of Ascending Node
RC	Range Coordinator
RCS	Reaction Control System
RCU	Remote Control Unit
R&D	Research and Development
RDU	Remote Data Unit
Rec	Recurring
Ref	Reference
RF	Radio Frequency
RFTS	Radio Frequency Test Set
RGU	Rate Gyro Unit
RH	Relative Humidity
RHC	Right Hand Circular
RLCC	Remote Launch Control Center
Rm	Room
ROCC	Range Operations Control Center
RP	Rocket Propellant
RPM	Revolutions Per Minute
RPO	Radiation Protection Officer
Rpt	Report
RRGU	Redundant Rate Gyro Unit
RSSR	Range Safety System Report
RTS	Remote Tracking Stations
s	second(s)
SAEF	Spacecraft Assembly and Encapsulation Facility
SAI	Safe/Arm Initiator
SAR	Safety Assessment Report
SAR	Software Anomaly Report
SAS	Special Aerospace Services
SC	Spacecraft
S/C	Spacecraft
SCAPE	Self-Contained Atmospheric-Protective Ensemble
SCTC	Spacecraft Test Conductor
SDO	San Diego Operations
SE	Single Engine
sec	second(s)
SEC	Single Engine Centaur
Sep	Separation
SERB	Systems Engineering Review Board
SFA	Single Flight Azimuth
SFT	Site Functional Team
SFTS	Secure Flight Termination System
SIL	Systems Integration Laboratory
SINDA	System-Improved Numerical Differencing Analyzer
SIP	Standard Interface Plane
SL	Sea Level

SLC	Space Launch Complex
SLV	Space Launch Vehicle
SMD	Spacecraft Mission Director
SOC	Spacecraft Operations Center
SOW	Statement of Work
SP	Secondary Payload
SPE	Suspect Product Evaluation
Spec	Specification
SPF	Single Point Failure
SPF	Spacecraft Processing Facility
SPL	Sound Pressure Level
SPRB	Space Program Reliability Board
SQP	Sequential Quadratic Programming
Sqrt	Square Root
SRB	Solid Rocket Booster
SRM	Solid Rocket Motor
SRR	Systems Requirements Review
SSI	Spaceport Systems International
Sta	Station
STC	Satellite Test Center
STE	Special Test Equipment
STEP	Standard for the Exchange of Product Model Data
STM	Structural Test Model
STV	Spacecraft Transportation Vehicle
SW	Switch
S/W	Software
Sync	Synchronous
TDRSS	Tracking and Data Relay Satellite System
Tech	Technical
Temp	Temperature
Tlm	Telemetry
TMM	Thermal Mathematical Model
TO	Transfer Orbit
TOPS	Transistorized Operational Phone System
TOR	Technical Operating Report (The Aerospace Corp)
TOS	Top Of Steel
TP	Twisted Pair
TRASYS	Thermal Radiation Analysis System
TSP	Twisted Shielded Pair
TST	Twisted Shielded Triples
TVC	Thrust Vector Control
TVCF	Transportable Vehicle Checkout Facility
UFOUO	Unclassified For Official Use Only
ULA	United Launch Alliance
ULPA	Ultra Low Penetration Air
ULS	United Launch Services
Umb	Umbilical

UPS	Uninterruptible Power System
URCU	Upper Stage Remote Control Unit
USAF	United States Air Force
UT	Umbilical Tower
V	volt(s)
Vac	volt(s), alternating current
Vac	Vacuum
VAFB	Vandenberg Air Force Base
Vdc	volt(s) direct current
VFA	Variable Flight Azimuth
VGP	Virtual Ground Plane
VIF	Vertical Integration Facility
V/m	volt(s) per meter
VoE	Vision of Excellence
VPRB	Vice President Review Board
VSS	Vertical Separation System
VTF	Vertical Test Facility
W	Watt(s)
W	Width
w/	With
WBB	Wide-Body Booster
WDR	Wet Dress Rehearsal
WR	Western Range
WRR	Western Range Regulation
WSMCR	Western Space and Missiles Control Regulation
Xdcr	Transducer
Xe	Gaseous Xenon
XEPF	Extra Extended Payload Fairing
XMTR	Transmitter
XPC	eXternal Payload Carrier